



# Surge Protection

Catalogue valid as of January 1, 2016





**DEHNshield ... 255 FM**

- Application-optimised and prewired spark-gap-based combined arrester for installation upstream of the meter
- Spark gap technology without venting means with a width of only 1 module / pole allows space-saving protection of terminal equipment
- Expansion of the portfolio with versions with remote signalling contact

Page 26/27



**DEHnbloc® Maxi 1 CI ... FM**

- Coordinated spark-gap-based lightning current arrester for a max. continuous operating voltage of 440 V or 760 V with an extremely high discharge capacity  $I_{imp}$  of 35 kA (10/350  $\mu$ s)
- No additional backup fuse required thanks to lightning current carrying integrated arrester backup fuse
- Space-efficient and installation time-saving surge protection for 400 / 690 V TN and IT systems
- Earthing clip for easy implementation of 3-0 or 4-0 circuits is available as accessory → Lightning-current-tested solution

Page 35/36



**DEHNguard® SE H LI 320/385/440 FM**

- Universal surge arrester consisting of a base part and a plug-in protection module
- Clear three-step Lifetime Indication (green-yellow-red) linked with remote signalling contact
- High discharge capacity  $I_{max}$  up to 65 kA (8/20  $\mu$ s)
- Expansion of the portfolio with versions with a maximum continuous operating voltage of 320 V, 385 V and 440 V

Page 64



**DEHNguard® SE H 1000 FM**

- Universal surge arrester consisting of a base part and a plug-in protection module
- Clear two-step Lifetime Indication linked with remote signalling contact
- Protection of power supply systems up to 1000 V integrated in a narrow 1.5 module enclosure combined with a high discharge capacity  $I_{max}$  von 40 kA (8/20  $\mu$ s)

Page 64



**BLITZDUCTOR® XT BPD 24**

- Combined arrester module for protecting two pairs in 24 V d.c. systems
- Integrated overcurrent protection masters short-circuit currents up to 40 A
- Can be tested by means of LifeCheck technology

Page 145



**DEHNvario DVR 2 BY S 150 FM**

- Lightning and surge protection for voice alarm and loudspeaker systems of security and building systems
- Direct plug-in technology allows fast connection without tools
- Pluggable terminal unit for easy arrester replacement
- Integrated remote signalling contact
- EMC-compatible due to direct / indirect shield earthing

Page 167



**DEHNpatch Class D**

- Surge arrester for Ethernet applications
- Use in structured cabling systems according to class D up to 100 MHz
- Power over Ethernet (PoE+ according to IEEE 802.3at)
- Ideally suited for retrofitting, protection of all lines

Page 190



**DEHNbox TC 180**

- Compact combined arrester with a high discharge capacity
- Universal solution for ISDN, analogue telephones and xDSL interfaces (up to VDSL 2)
- Fast and easy installation thanks to spring-loaded terminals
- IP 65 enclosure suitable for wall mounting

Page 198



**Coax Connection Box NAK SN4631**

- Aboveground connection of EXFS 100 isolating spark gaps with coaxial connecting cable to buried insulating joints / flanges
- Provides an up to three times higher protective effect than conventional connection systems with a comparable connecting cable length
- Low sparkover voltage
- UV-resistant and extremely robust IP 67 aluminium enclosure can also be used in rough environments

Page 226



**VCSD 40 IP65**

- Voltage-controlled short-circuiter provides protection in case of transient, temporary and long-duration overvoltages caused by lightning interference, stray currents, electromagnetic fields, earth faults and short-circuits
- Protection of installations, components and people
- Adjustable response threshold for flexible use in a wide range of application and operating states
- Intelligent decoupling device with external control in an IP 65 enclosure indicates device faults and signals the instantaneous value of the a.c. discharge current by a 4-20 mA signal (max. 40  $A_{eff}$ )

Page 227

<b>Foreword</b>	<b>3</b>
New Products	Cover
Our Promise – DEHN protects.	3
DEHN – International	4
Planned Safety	5
Terms and Definitions / Definition of Symbols	9
 DEHNselect SPD Tool – Planning of internal lightning protection and surge protection <b>NEW</b>	13
Selection Charts – Industrial, Office and Residential Buildings	13-1



<b>Surge Protection for Power Supply Systems</b>	<b>Red   Line®</b>	<b>15</b>
Combined Arresters – Type 1		18
Lightning Current Arresters – Type 1		31
N-PE Lightning Current Arresters		47
Surge Arresters – Type 2		50
Surge Arresters – Type 3		89
General Accessories		105



<b>Surge Protection for Information Technology Systems</b>	<b>Yellow   Line</b>	<b>115</b>
Easy Choice according to Interface/Signal		121
Pluggable SPDs – DIN Rail mounted		141
Terminal Block SPDs – DIN Rail mounted		163
Compact SPDs – DIN Rail mounted		167
SPDs for LSA Technology		173
SPDs for Field Devices		183
SPDs for Telecommunication and Data Networks		189
SPDs for Building Systems		193
SPDs for Coaxial Connection		201
SPDs for SUB-D Connection		207
Shield Connection Systems and Enclosures		209
Measuring and Test Devices		215



<b>Lightning Equipotential Bonding</b>	<b>221</b>
Isolating Spark Gaps	222
Voltage Controlled Short-Circuiting Device	227
Ex Pipe Clamps	229
Voltage Limiters	231
Equipotential Bonding	235

<b>Index</b>	<b>241</b>
Publications of the DEHNgroup / References	241
Old / Discontinued Products / Alternatives	244
Part No. Index / Type Index	245
Key Words	254
General Terms of Sale	Cover

Surge Protection Main Catalogue valid as of January 1, 2016

This catalogue replaces the Surge Protection Main Catalogue 2014/2015.

We reserve the right to introduce changes in configuration and technology, dimensions, weights and materials within the scope of technical progress. Illustrations are not binding. We accept no liability for misprints, modifications and errors. Any reproduction of this catalogue, as a whole or in parts, is only allowed upon approval of DEHN + SÖHNE.



Our promise



"We are a reliable partner for our customers and employees."

Dr. Philipp Dehn  
Managing Partner / CEO

## DEHN protects.

Dear customers, friends, partners,

Every facet of life, whether business or private, is today highly complex. In order to cater to your ever increasing needs and, at the same time, promote your well-being, we provide innovations and manifold new products. We offer comprehensive protection solutions which, obviously, go hand in hand with the appropriate service. The key to the implementation of protection solutions for our and your own customers is in-depth and comprehensive consultation. Extended services and improved processes help both you and us to transform requirements into possibilities. We would like you, as our partner, to link up your protection requirements and needs with our services and expertise, in order for us both to reap the mutual advantages. Our new and constantly evolving protection concepts are designed to make your daily life and surroundings safer.

Of course, we also continue to provide all of Dehn's traditional, reliable products and safety solutions. We aim to be your safety partner worldwide for surge and lightning protection and safety equipment. Effective protection against the risks presented by lightning and surges for people and equipment is our business. A feel for the market, determination and ideas are the lifeblood for new safety products and concepts. This is the main focus of our family business and has, coupled with the pioneering spirit and innovation which have been our trademark for more than 100 years, made us a market leader with about 1700 employees.

The hub of our activities is in Neumarkt in Bavaria, Germany. It is here that developers work with project and product managers to further advance our protection technology. And it is here that we produce your safety products. Every day we endeavour to ensure that your business can continue to grow thanks to our innovative solutions and services. The DEHN brand name stands for innovation, consistent customer and market orientation and the highest possible quality. Now and in the future.

Take advantage of our range of surge and lightning protection and safety equipment and join us in providing a tad more safety.

I look forward to your interest and future cooperation with you.

Dr. Philipp Dehn



"Our customers are the focal point of our activities."

Helmut Pusch  
Managing Director / CSO

## Fair partnership for the best solution

Our goal is to be a reliable and fair partner for our industrial, commercial and technical customers all over the world. To this end, we always focus on the best protection solution.

Our sales teams in Germany, our global network of 20 subsidiaries and offices as well as more than 70 international sales partners ensure the competent and customer-oriented marketing of our products. Proximity to and close contact with our customers is of utmost importance to us, be it on-site support by our experienced team, our telephone hotline or personal contact at trade fairs. In hundreds of seminars, workshops and conferences held every year throughout the world, we impart practical knowledge on our products and solutions based on specific sample applications, technical and physical correlations and standardisation.

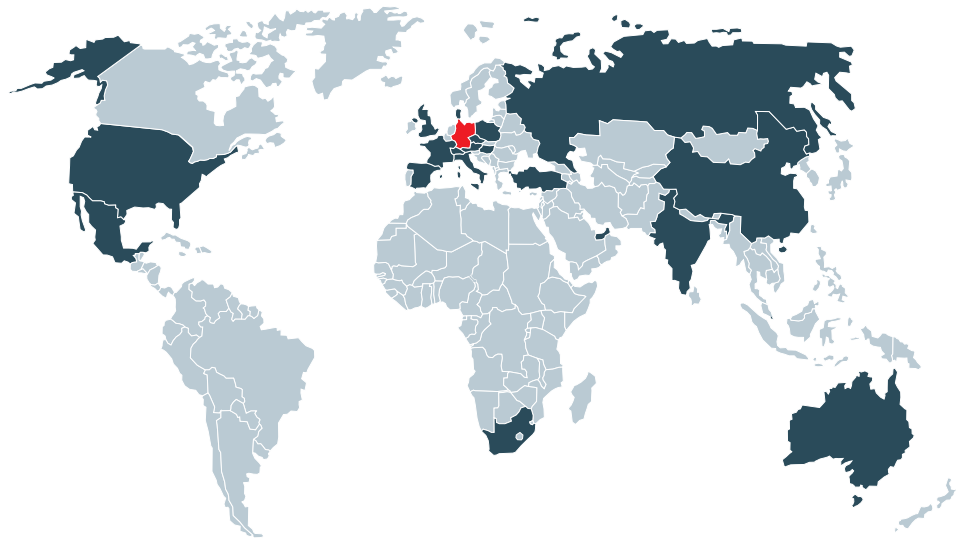

## DEHN + SÖHNE GmbH + Co.KG.

**International Sales Department**  
sales@dehn.de  
Phone +49 9181 906 1462  
Fax +49 9181 906 1444

**International Technical Services & Support**  
ITSS@dehn.de  
Phone +49 9181 906 1045  
Fax +49 9181 906 1046

## Subsidiaries and representative offices

<b>Australia:</b>	DEHN office Melbourne	<a href="http://www.dehn.com.au">www.dehn.com.au</a>
<b>Austria:</b>	DEHN AUSTRIA GmbH	<a href="http://www.dehn.at">www.dehn.at</a>
<b>China:</b>	DEHN Surge Protection (Shanghai) Co. Ltd.	<a href="http://www.dehn.cn">www.dehn.cn</a>
<b>Czech Republic:</b>	DEHN office Prague	<a href="http://www.dehn.cz">www.dehn.cz</a>
<b>Denmark:</b>	DESITEK A/S	<a href="http://www.desitek.dk">www.desitek.dk</a>
<b>France:</b>	DEHN FRANCE S.à.r.l.	<a href="http://www.dehn.fr">www.dehn.fr</a>
<b>Great Britain:</b>	DEHN (U.K.) LTD.	<a href="http://www.dehn.co.uk">www.dehn.co.uk</a>
<b>Hungary:</b>	DEHN office Budapest	<a href="http://www.dehn.hu">www.dehn.hu</a>
<b>India:</b>	DEHN INDIA Pvt. Ltd.	<a href="http://www.dehn.in">www.dehn.in</a>
<b>Italy:</b>	DEHN ITALIA S.p.A.	<a href="http://www.dehn.it">www.dehn.it</a>
<b>Mexico:</b>	DEHN PROTECTION MÉXICO, S.A. de C.V.	<a href="http://www.dehn.mx">www.dehn.mx</a>
<b>Poland:</b>	DEHN POLSKA Sp. z o.o.	<a href="http://www.dehn.pl">www.dehn.pl</a>
<b>Russia:</b>	OOO DEHN RUS	<a href="http://www.dehn-ru.com">www.dehn-ru.com</a>
<b>Singapore:</b>	DEHN (SEA) PTE. LTD.	<a href="http://www.dehn.sg">www.dehn.sg</a>
<b>South Africa:</b>	DEHN AFRICA (Pty) Ltd.	<a href="http://www.dehn-africa.com">www.dehn-africa.com</a>
<b>Spain:</b>	DEHN IBÉRICA Protecciones Eléctricas, S.A. Unipersonal	<a href="http://www.dehn.es">www.dehn.es</a>
<b>Switzerland:</b>	ELVATEC AG	<a href="http://www.elvatec.ch">www.elvatec.ch</a>
<b>Turkey:</b>	DEHN office Istanbul	<a href="http://www.dehn.com.tr">www.dehn.com.tr</a>
<b>United Arab Emirates:</b>	DEHN MIDDLE EAST FZE	<a href="http://www.dehn.ae">www.dehn.ae</a>
<b>USA:</b>	DEHN Inc.	<a href="http://www.dehn-usa.com">www.dehn-usa.com</a>

## Sales activities in more than 70 countries worldwide

At [www.dehn-international.com](http://www.dehn-international.com) you can find your local contact partner.

Failure of technical installations and systems in residential and functional buildings is very unpleasant and expensive. Therefore, faultless operation of devices must be ensured both during normal operation and thunderstorms. The number of annually registered lightning activities in Germany maintained at a constantly high level over many years. Damage statistics of insurance companies clearly show that there are deficits in terms of lightning and surge protection measures both in the private and commercial sector (Figure 1).

A professional solution allows to take adequate protection measures. The lightning protection zone concept, for example, enables designers, constructors and operators of buildings and installations to consider, implement and monitor different protection measures. All relevant devices, installations and systems are thus reliably protected at a reasonable expense.

### Sources of interference

Surges occurring during a thunderstorm are caused by direct / nearby lightning strikes or remote lightning strikes (Figure 2 and Figure 3). Direct or nearby lightning strikes are lightning strikes to a building, its surroundings or electrically conductive systems entering the building (e.g. low-voltage supply, telecommunication and data lines). The resulting impulse currents and impulse voltages as well as the associated electromagnetic field (LEMP) are particularly dangerous for the devices and installations to be protected with regard to the amplitude and energy content involved. In case of a direct or nearby lightning strike, surges are caused by the voltage drop at the conventional earthing impedance  $R_{St}$  and the resulting potential rise of the building in relation to the remote earth (Figure 3, case 2). This means the highest load for electrical installations in buildings.

The characteristic parameters of the impulse current present (peak value, rate of current rise, charge, specific energy) can be described by means of the 10/350  $\mu$ s impulse current wave form. They have been defined in international, European and national standards as test current for components and devices protecting against direct lightning strikes (Figure 4).

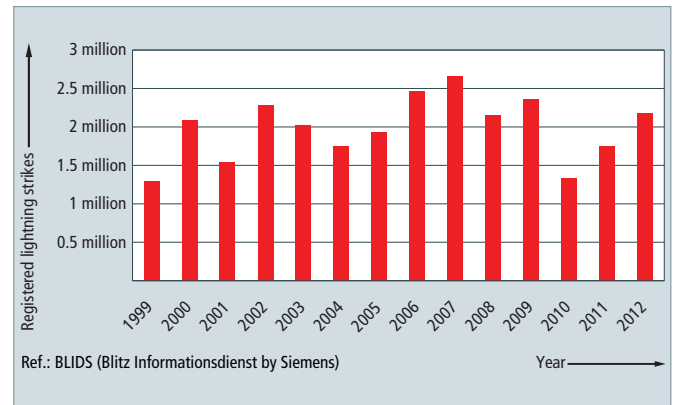

Figure 1: Lightning activity registered in Germany from 1999 to 2012.

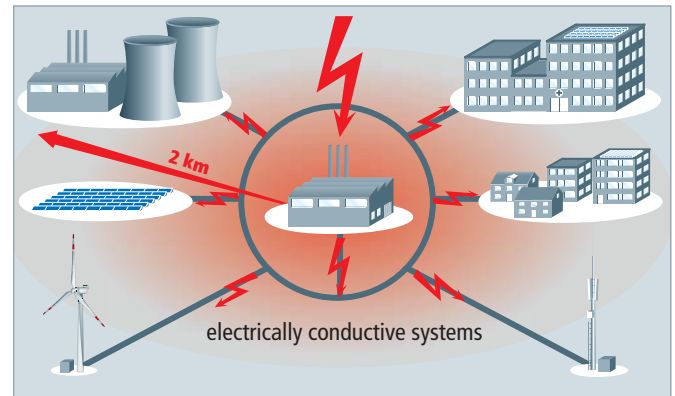

Figure 2: General risks for buildings and installations resulting from lightning strikes.

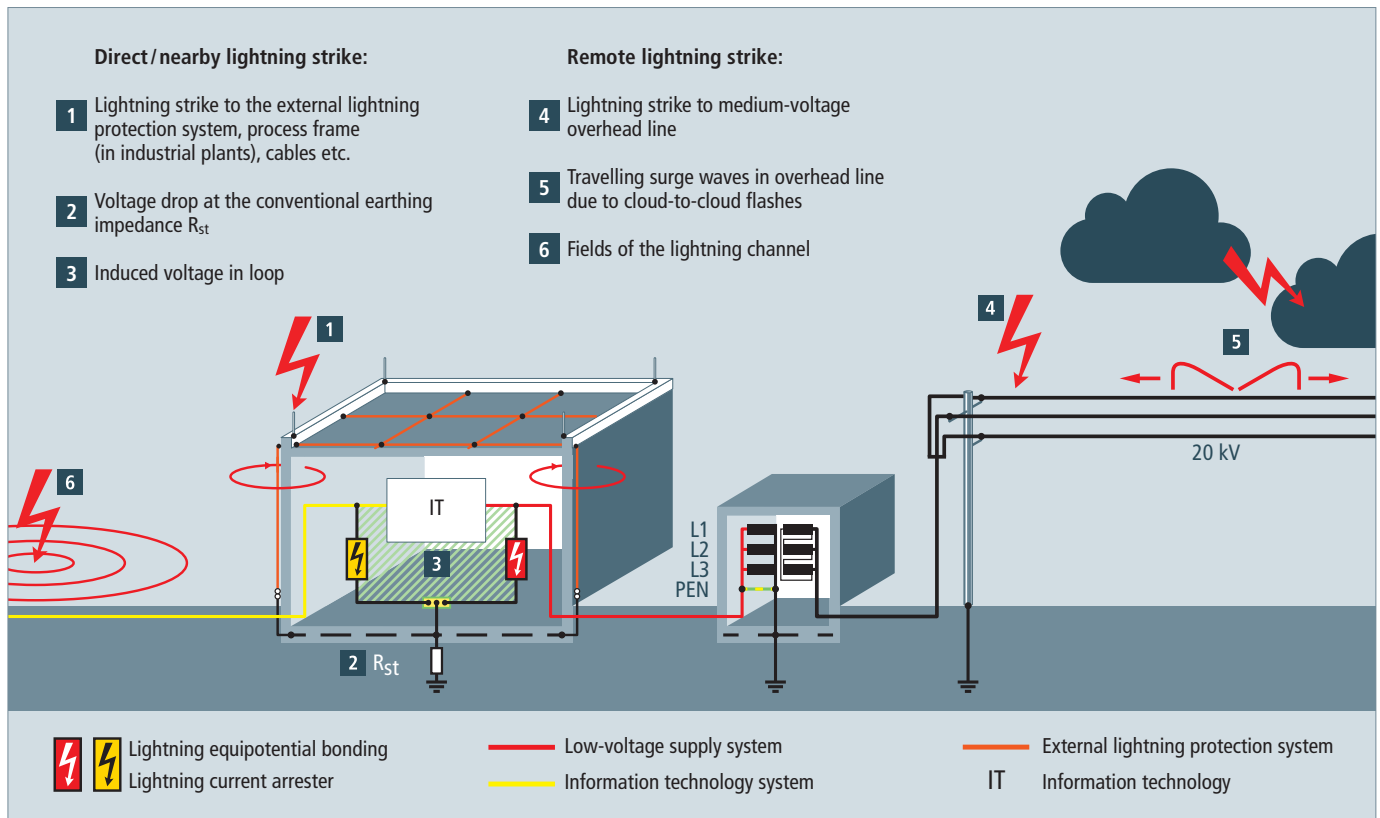

Figure 3: Causes of surges during lightning discharges.

In addition to the voltage drop at the conventional earthing impedance, surges are generated in the electric building installation and the systems and devices connected to it due to the inductive effect of the electromagnetic lightning field (Figure 3, case 3). The energy of these induced surges and of the resulting impulse currents is far lower than the energy of a direct lightning impulse current and is therefore described by a 8/20  $\mu$ s impulse current wave form (Figure 4). Components and devices that do not have to conduct currents resulting from direct lightning strikes are therefore tested with such 8/20  $\mu$ s impulse currents.

### Protection scheme

Lightning strikes are called remote if they occur at a farer distance to the object to be protected, strike medium-voltage overhead lines or their surroundings or occur as cloud-to-cloud lightning discharges (Figure 3, cases 4, 5, 6). Similar to induced surges, the effects of remote lightning strikes on the electrical installation of a building are handled by devices and components which have been dimensioned according to 8/20  $\mu$ s impulse current waves. Surges caused by switching operations (SEMP) are, for example, generated by:

- Disconnection of inductive loads (e.g. transformers, reactors, motors)
- Arc ignition and interruption (e.g. arc welding equipment)
- Tripping of fuses

The effects of switching operations in the electrical installation of a building can also be simulated by impulse currents of 8/20  $\mu$ s wave form under test conditions. To ensure continuous availability of complex power supply and information technology systems even in case of direct lightning interference, further surge protection measures for electrical and electronic installations and devices based on a lightning protection system for the building are required. It is important to take all causes of surges

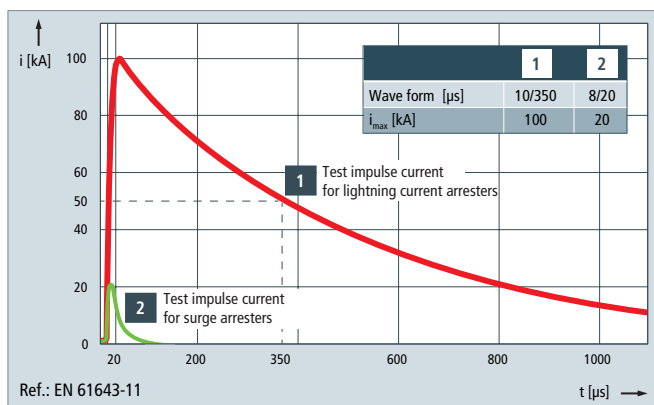

Figure 4: Test impulse currents for lightning current and surge arresters.

into account. To do so, the lightning protection zone concept as described in IEC 62305-4 is applied (Figure 5).

### Lightning protection zone concept

The building is divided into different endangered zones. These zones help to define the necessary protection measures, in particular the lightning and surge protection devices and components. Part of an EMC compatible (Electromagnetic Compatibility) lightning protection zone concept is the external lightning protection system (including air-termination system, down-conductor system, earth-termination system), equipotential bonding, spatial shielding and surge protection for the power supply and information technology systems. Definitions apply as classified in Table 1.

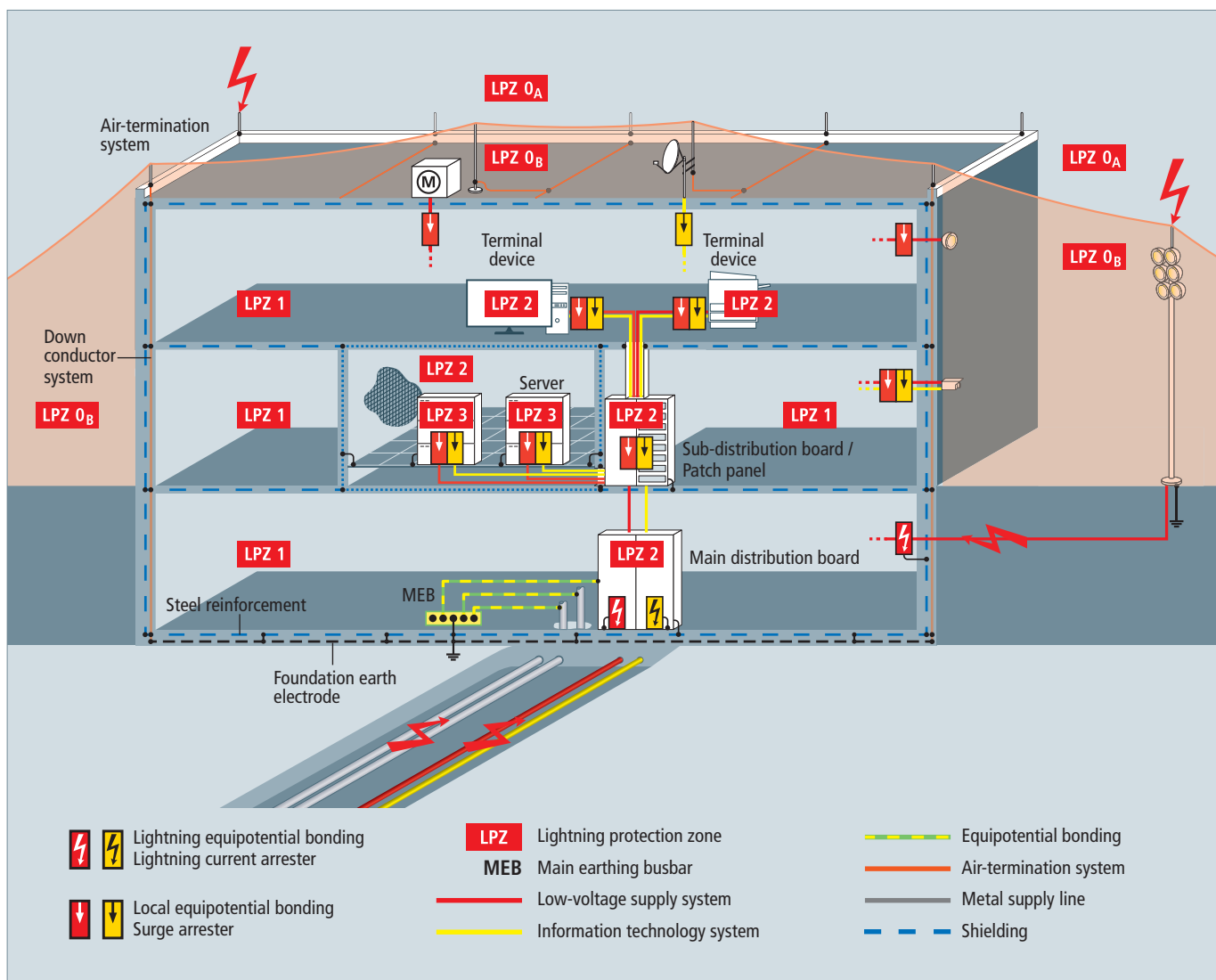
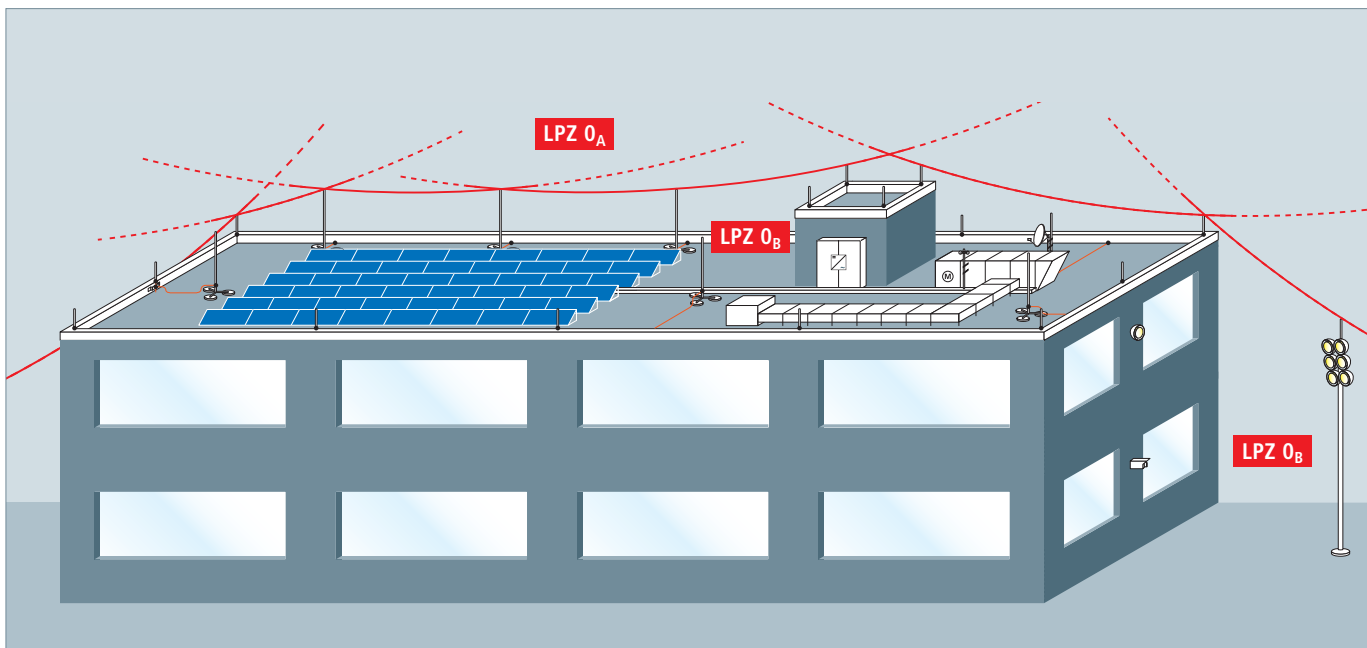

Figure 5: Overall view of a lightning protection zone concept.





▲ Figure 5.1: Transition from LPZ 0<sub>A</sub> to LPZ 0<sub>B</sub> (above)

▼ Figure 5.2: Transitions from LPZ 0<sub>A</sub> to LPZ 1 and LPZ 0<sub>B</sub> to LPZ 1 (below)

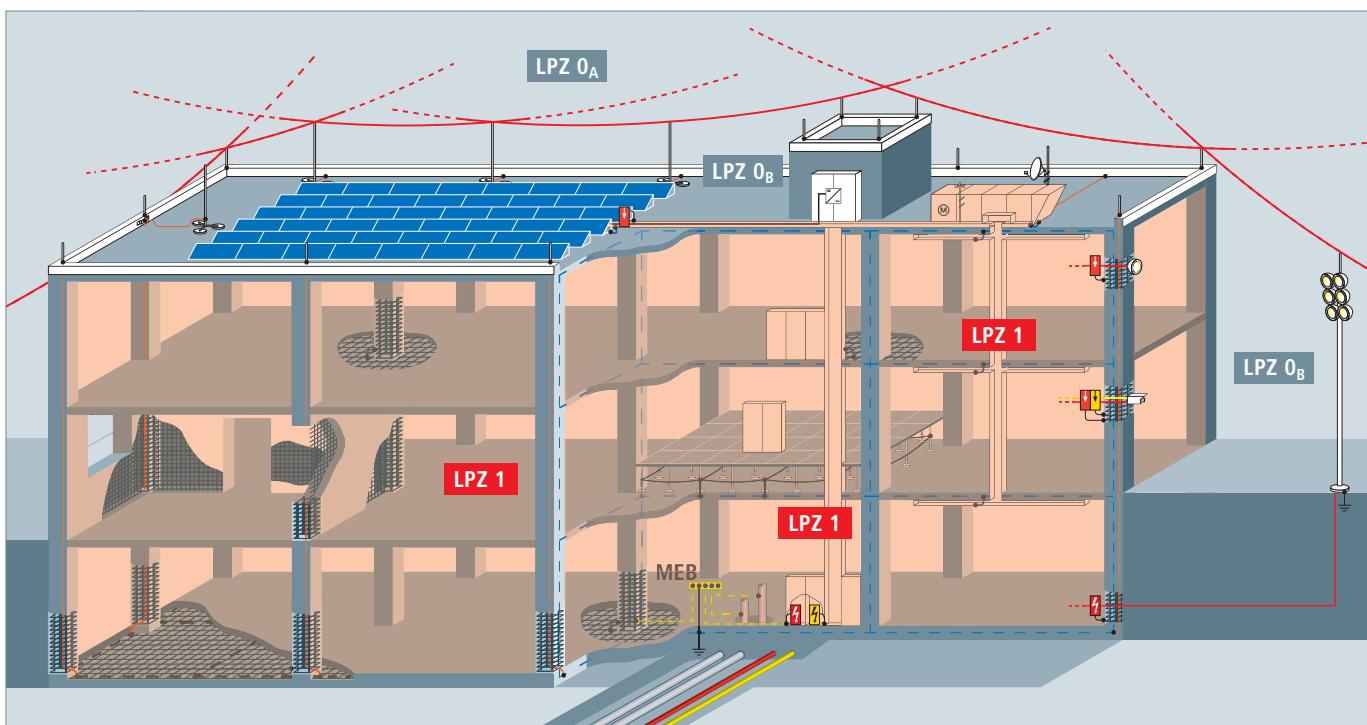

According to the requirements and loads placed on surge protective devices, they are categorised as lightning current arresters, surge arresters and combined arresters. The highest requirements are placed on the discharge capacity of lightning current arresters and combined arresters used at the transition from lightning protection zone 0<sub>A</sub> to 1 or 0<sub>A</sub> to 2. These arresters must be capable of conducting partial lightning currents of 10/350  $\mu$ s wave form several times without being destroyed in order to prevent the ingress of destructive partial lightning currents into the electrical installation of a building. At the transition point from LPZ 0<sub>B</sub> to 1 or downstream of the lightning current arrester at the transition point from LPZ 1 to 2 and higher, surge arresters are used to protect against surges. Their task is both to reduce the residual energy of the upstream

protection stages even further and to limit the surges induced or generated in the installation itself.

The lightning and surge protective measures at the boundaries of the lightning protection zones described above equally apply to power supply and information technology systems. All measures described in the EMC compatible lightning protection zone concept help to achieve continuous availability of electrical and electronic devices and installations.

For more detailed technical information, DEHN offers a "Lightning Protection Guide" which can be downloaded at [www.dehn-international.com/en/downloads](http://www.dehn-international.com/en/downloads).

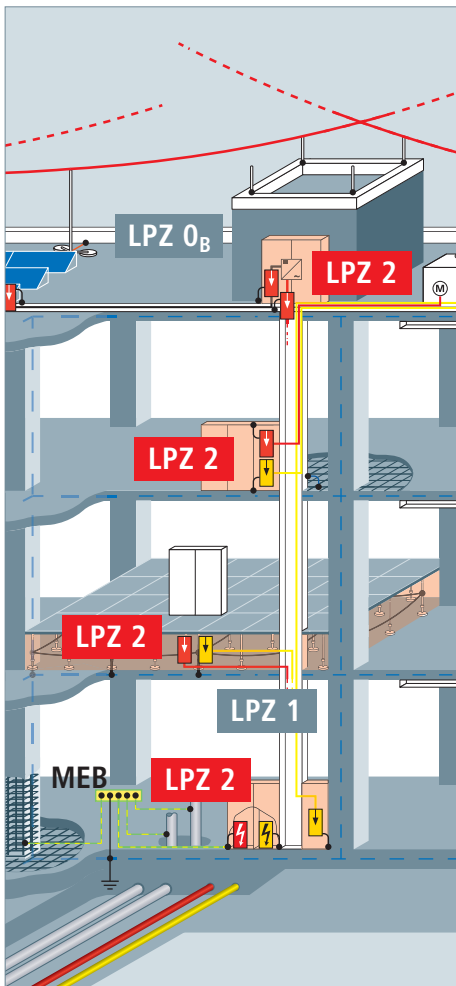

Figure 5.3: Transition from LPZ 1 to LPZ 2

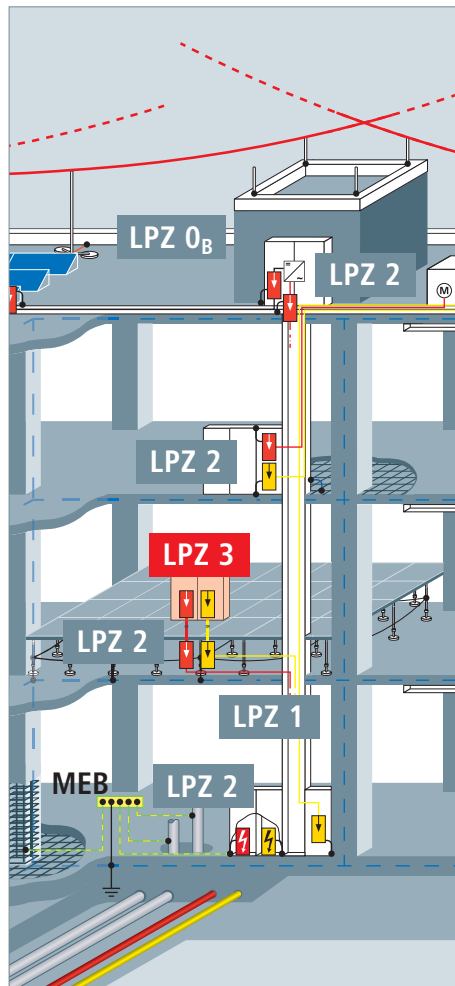
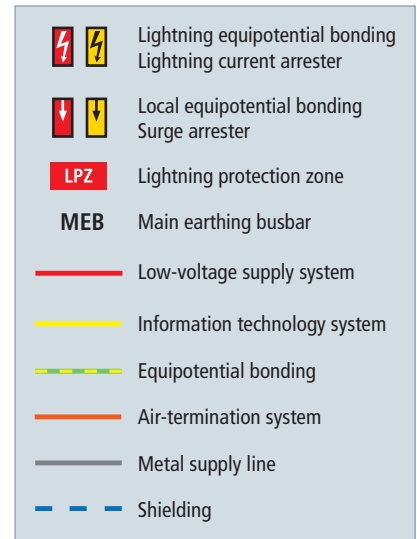

Figure 5.4: Transition from LPZ 2 to LPZ 3



IEC 62305-4:2010

Outer zones:

**LPZ 0** Zone where the threat is due to the unattenuated lightning electromagnetic field and where the internal systems may be subjected to full or partial lightning surge current.

LPZ 0 is subdivided into:

**LPZ 0<sub>A</sub>** Zone where the threat is due to the direct lightning flash and the full lightning electromagnetic field. The internal systems may be subjected to full lightning surge current.

**LPZ 0<sub>B</sub>** Zone protected against direct lightning flashes but where the threat is the full lightning electromagnetic field. The internal systems may be subjected partial lightning surge currents.

Inner zones (protected against direct lightning flashes):

**LPZ 1** Zone where the surge current is limited by current sharing and isolating interfaces and/or by SPDs at the boundary. Spatial shielding may attenuate the lightning electromagnetic field.

**LPZ 2 ... n** Zone where the surge current may be further limited by current sharing and isolating interfaces and/or by additional SPDs at the boundary. Additional spatial shielding may be used to further attenuate the lightning electromagnetic field.

Table 1: Definition of lightning protection zones.

## Surge Protective Devices (SPDs)

Surge protective devices are devices consisting mainly of voltage-controlled resistors (varistors, suppressor diodes) and/or spark gaps (discharge paths). Surge protective devices are used to protect other electrical equipment and installations against impermissibly high surges and/or to establish equipotential bonding.

Surge protective devices are classified:

a) according to their use into:

- **Surge protective devices for power supply systems and equipment (Red/Line product family)**  
for nominal voltage ranges up to 1000 V  
– according to EN 61643-11:2012 in type 1 / 2 / 3 SPDs  
– according to IEC 61643-11:2011 in class I / II / III SPDs
- **Surge protective devices for IT systems and equipment (Yellow/Line product family)**  
for protecting modern electronic systems in telecommunications and signal-processing networks with nominal voltages up to 1000 V a.c. [root-mean-square value (rms)] and 1500 V d.c. against the indirect and direct effects of lightning strikes and other transients.  
– according to IEC 61643-21:2012, EN 61643-21:2013 and DIN VDE 0845-3-1.
- **Isolating spark gaps for earth-termination systems or equipotential bonding (Red/Line® product family)**
- **Surge protective devices for use in photovoltaic installations (Red/Line® product family)**  
for nominal voltage ranges up to 1500 V  
– according to EN 50539-11:2013 as type 1 / 2 SPDs

b) according to their impulse current discharge capacity and protective effect into:

- **Lightning current arresters / Coordinated lightning current arresters**  
for interference resulting from direct or nearby lightning strikes for protecting installations and equipment [for use at the boundaries between lightning protection zones (LPZ) 0<sub>A</sub> and 1].
- **Surge arresters**  
for remote lightning strikes, switching overvoltages as well as electrostatic discharges for protecting installations, equipment and terminal devices (for use at the boundaries downstream of LPZ 0<sub>B</sub>).
- **Combined lightning current and surge arresters**  
for interference resulting from direct or nearby lightning strikes for protecting of installations, equipment and terminal devices (for use at the boundaries between LPZ 0<sub>A</sub> and 1 as well as 0<sub>A</sub> and 2).

## Technical data

The technical data of surge protective devices comprise information defining their conditions of use according to:

- use (e.g. installation, power supply conditions, temperature)
- performance in case of interference (e.g. impulse current discharge capacity, follow current extinguishing capability, voltage protection level, response time)
- performance during operation (e.g. nominal current, attenuation, insulation resistance)
- performance in case of failure (e.g. backup fuse, disconnection device, fail-safe, remote signalling option).

### actiVsense®

The actiVsense technology is integrated in universal combined arresters for protecting information technology installations and devices. The arrester automatically detects the signal voltage applied and optimally adapts the voltage protection level to it. Thus, the arrester can be universally used for different interfaces and provides maximum protection for the devices and system circuits connected to it in case of failure.

### Breaking capacity, follow current extinguishing capability I<sub>n</sub>

The breaking capacity is the uninfluenced (prospective) r.m.s. value of the mains follow current which can automatically be extinguished by the surge protective device when connecting U<sub>c</sub>. It can be proven in an operating duty test according to IEC/EN 61643-11.

### Categories according to IEC 61643-21:2012

A number of impulse voltages and impulse currents are described in IEC 61643-21:2012 for testing the current carrying capability and voltage limitation of impulse interference. Table 3 of this standard lists these into categories and provides preferred values. In Table 2 of the IEC 61643-22 standard the sources of transients are assigned to the different impulse categories according to the decoupling mechanism. Category C2 includes inductive coupling (surges), category D1 galvanic coupling (lightning currents). The relevant category is specified in the technical data.

DEHN + SÖHNE surge protective devices surpass the values in the specified categories. Therefore, the exact value for the impulse current carrying capability is indicated by the nominal discharge current (8/20 µs) and the lightning impulse current (10/350 µs).

### Combination wave U<sub>oc</sub>

A combination wave is generated by a hybrid generator (1.2/50 µs, 8/20 µs) with a fictitious impedance of 2 Ω. The open-circuit voltage of this generator is referred to as U<sub>oc</sub>. U<sub>oc</sub> is a preferred indicator for type 3 arresters since only these arresters may be tested with a combination wave (according to IEC/EN 61643-11).

### Cut-off frequency f<sub>c</sub>

The cut-off frequency defines the frequency-dependent behaviour of an arrester. The cut-off frequency is equivalent to the frequency which induces an insertion loss (a<sub>E</sub>) of 3 dB under certain test conditions (see EN 61643-21:2013). Unless otherwise indicated, this value refers to a 50 Ω system.

### Degree of protection

The IP degree of protection corresponds to the protection categories described in IEC/EN 60529.

### Direct Current Disconnection

When using surge arresters in d.c. applications, disconnection must be reliably ensured even if there are no zero crossings. The specifically developed DC Disconnection (DCD) acts as a wedge similar to a blocking valve and interrupts the direct current. Consequently, the devices of the DEHN-guard SE DC series are capable of safely interrupting direct currents, thus preventing fire damage caused by d.c. switching arcs.

### Disconnecting time t<sub>a</sub>

The disconnecting time is the time passing until the automatic disconnection from power supply in case of a failure of the circuit or equipment to be protected. The disconnecting time is an application-specific value resulting from the intensity of the fault current and the characteristics of the protective device.

### Energy coordination of SPDs

Energy coordination is the selective and coordinated interaction of cascaded protection elements (= SPDs) of an overall lightning and surge protection concept. This means that the total load of the lightning impulse current is split between the SPDs according to their energy carrying capability. If energy coordination is not possible, downstream SPDs are insufficiently relieved by the upstream SPDs since the upstream SPDs operate too late, insufficiently or not at all. Consequently, downstream SPDs as well as terminal equipment to be protected may be destroyed. DIN CLC/TS 61643-12:2010 describes how to verify energy coordination. Spark-gap-based type 1 SPDs offer considerable advantages due to their voltage-switching characteristic (see WAVE BREAKER FUNCTION).

### Frequency range

The frequency range represents the transmission range or cut-off frequency of an arrester depending on the described attenuation characteristics.

### Insertion loss

With a given frequency, the insertion loss of a surge protective device is defined by the relation of the voltage value at the place of installation before and after installing the surge protective device. Unless otherwise indicated, the value refers to a 50 Ω system.

### Integrated backup fuse

According to the product standard for SPDs, overcurrent protective devices / backup fuses must be used. This, however, requires additional space in the distribution board, additional cable lengths, which should be as short as possible according to IEC 60364-5-53, additional installation

time (and costs) and dimensioning of the fuse. A fuse integrated in the arrester ideally suited for the impulse currents involved eliminates all these disadvantages. The space gain, lower wiring effort, integrated fuse monitoring and the increased protective effect due to shorter connecting cables are clear advantages of this concept which is integrated in the DEHNvenCI, DEHNbloc Maxi S, DEHNguard ... CI and V(A) NH product families.

**LifeCheck®**

Repeated discharge processes which exceed the specification of the device can overload arresters in information technology systems. In order to ensure high system availability, arresters should therefore be subjected to systematic tests. LifeCheck allows quick and easy testing of arresters (see page 121).

**Lightning impulse current  $I_{imp}$**

The lightning impulse current is a standardised impulse current curve with a 10/350  $\mu$ s wave form. Its parameters (peak value, charge, specific energy) simulate the load caused by natural lightning currents. Lightning current and combined arresters must be capable of discharging such lightning impulse currents several times without being destroyed.

**Mains-side overcurrent protection / arrester backup fuse**

Overcurrent protective device (e.g. fuse or circuit breaker) located outside of the arrester on the infeed side to interrupt the power-frequency follow current as soon as the breaking capacity of the surge protective device is exceeded. No additional backup fuse is required since the backup fuse is already integrated in the SPD (see relevant section).

**Maximum continuous operating voltage  $U_C$**

The maximum continuous operating voltage (maximum permissible operating voltage) is the r.m.s. value of the maximum voltage which may be connected to the corresponding terminals of the surge protective device during operation. This is the maximum voltage on the arrester in the defined non-conducting state, which reverts the arrester back to this state after it has tripped and discharged. The value of  $U_C$  depends on the nominal voltage of the system to be protected and the installer's specifications (IEC 60364-5-534).

**Maximum continuous operating voltage  $U_{CPV}$  for a photovoltaic (PV) system**

Value of the maximum d.c. voltage that may be permanently applied to the terminals of the SPD. To ensure that  $U_{CPV}$  is higher than the maximum open-circuit voltage of the PV system in case of all external influences (e.g. ambient temperature, solar radiation intensity),  $U_{CPV}$  must be higher than this maximum open-circuit voltage by a factor of 1.2 (according to CLC/TS 50539-12). This factor of 1.2 ensures that the SPDs are not incorrectly dimensioned.

**Maximum discharge current  $I_{max}$**

The maximum discharge current is the maximum peak value of the 8/20  $\mu$ s impulse current which the device can safely discharge.

**Maximum transmission capacity**

The maximum transmission capacity defines the maximum high-frequency power which can be transmitted via a coaxial surge protective device without interfering with the protection component.

**Nominal discharge current  $I_n$**

The nominal discharge current is the peak value of a 8/20  $\mu$ s impulse current for which the surge protective device is rated in a certain test programme and which the surge protective device can discharge several times.

**Nominal load current (nominal current)  $I_L$**

The nominal load current is the maximum permissible operating current which may permanently flow through the corresponding terminals.

**Nominal voltage  $U_N$**

The nominal voltage stands for the nominal voltage of the system to be protected. The value of the nominal voltage often serves as type designation for surge protective devices for information technology systems. It is indicated as an r.m.s. value for a.c. systems.

**N-PE arrester**

Surge protective devices exclusively designed for installation between the N and PE conductor.

**Operating temperature range  $T_U$**

The operating temperature range indicates the range in which the devices can be used. For non-self-heating devices, it is equal to the ambient temperature range. The temperature rise for self-heating devices must not exceed the maximum value indicated.

**Protective circuit**

Protective circuits are multi-stage, cascaded protective devices. The individual protection stages may consist of spark gaps, varistors, semiconductor elements and gas discharge tubes (see Energy coordination).

**Protective conductor current  $I_{PE}$**

The protective conductor current is the current which flows through the PE connection when the surge protective device is connected to the maximum continuous operating voltage  $U_C$ , according to the installation instructions and without load-side consumers.

**Remote signalling contact**

A remote signalling contact allows easy remote monitoring and indication of the operating state of the device. It features a three-pole terminal in the form of a floating changeover contact. This contact can be used as break and / or make contact and can thus be easily integrated in the building control system, controller of the switchgear cabinet, etc.

**Response time  $t_A$**

Response times mainly characterise the response performance of individual protection elements used in arresters. Depending on the rate of rise  $du/dt$  of the impulse voltage or  $di/dt$  of the impulse current, the response times may vary within certain limits.

**Return loss**

In high-frequency applications, the return loss refers to how many parts of the "leading" wave are reflected at the protective device (surge point). This is a direct measure of how well a protective device is attuned to the characteristic impedance of the system.

**SCI technology**

Direct currents (d.c.) flow on the generator side of a PV system. The surge protective devices used on the generator side can be overloaded due to different scenarios (e.g. impulse load, insulation faults) and must not endanger the PV system. However, insufficient d.c. disconnection capability in a PV system may cause fire. Conventional surge arresters only feature a disconnecter in the form of a simple break contact mechanism which is typically used for a.c. devices. Due to the lacking zero crossing of the d.c. source, a d.c. arc may persist and cause fire. The SCI technology patented by DEHN + SÖHNE with active arc extinction is an ideal solution. In case of overload, a contact is opened and a short-circuit is generated (Short Circuit). Thus, a possible switching arc is actively, quickly and safely extinguished. The PV fuse integrated in the short-circuit path immediately trips after the arc has been extinguished and ensures safe electrical isolation (Interruption) (see also pages 28/69-77). Thus, all PV arresters from DEHN + SÖHNE combine surge protection, fire protection and personal protection in a single device.

**Series resistance**

Resistance in the direction of the signal flow between the input and output of an arrester.

**Shield attenuation**

Relation of the power fed into a coaxial cable to the power radiated by the cable through the phase conductor.

**Short-circuit withstand capability**

The short-circuit withstand capability is the value of the prospective power-frequency short-circuit current handled by the surge protective device when the relevant maximum backup fuse is connected upstream.

**Short-circuit rating  $I_{SCPV}$  of an SPD in a photovoltaic (PV) system**

Maximum uninfluenced short-circuit current which the SPD, alone or in conjunction with its disconnection devices, is able to withstand.

### Temporary overvoltage (TOV)

Temporary overvoltage may be present at the surge protective device for a short period of time due to a fault in the high-voltage system. This must be clearly distinguished from a transient caused by a lightning strike or a switching operation, which last no longer than about 1 ms. The amplitude  $U_T$  and the duration of this temporary overvoltage are specified in EN 61643-11 (200 ms, 5 s or 120 min.) and are individually tested for the relevant SPDs according to the system configuration (TN, TT, etc.). The SPD can either a) reliably fail (TOV safety) or b) be TOV-resistant (TOV withstand), meaning that it is completely operational during and following temporary overvoltages.

### Thermal disconnecter

Surge protective devices for use in power supply systems equipped with voltage-controlled resistors (varistors) mostly feature an integrated thermal disconnecter that disconnects the surge protective device in case of overload and indicates this operating state. The disconnecter responds to the "current heat" generated by an overloaded varistor and disconnects the surge protective device if a certain temperature is exceeded. The disconnecter is designed to disconnect the overloaded surge protective device in time to prevent a fire. It is not intended to ensure protection against indirect contact. The function of these thermal disconnecters can be tested by means of a simulated overload / ageing of the arresters.

### Total discharge current $I_{total}$

Current which flows through the PE, PEN or earth connection of a multipole SPD during the total discharge current test. This test is used to determine the total load if current simultaneously flows through several protective paths of a multipole SPD. This parameter is decisive for the total discharge capacity which is reliably handled by the sum of the individual paths of an SPD.

### Voltage protection level $U_p$

The voltage protection level of a surge protective device is the maximum instantaneous value of the voltage at the terminals of a surge protective device, determined from the standardised individual tests:

- Lightning impulse sparkover voltage 1,2/50  $\mu$ s (100%)
- Sparkover voltage with a rate of rise of 1 kV/ $\mu$ s
- Measured limit voltage at a nominal discharge current  $I_n$

The voltage protection level characterises the capability of a surge protective device to limit surges to a residual level. The voltage protection level defines the installation location with regard to the overvoltage category according to IEC 60664-1 in power supply systems. For surge protective devices to be used in information technology systems, the voltage protection level must be adapted to the immunity level of the equipment to be protected (IEC 61000-4-5: 2015).

### Wave breaker function



Due to the technical design of type 1 SPDs, energy coordination of SPDs considerably varies. Experience has shown that even small amplitudes of the 10/350  $\mu$ s lightning impulse current overload downstream SPDs or even destroy them if varistor-based type 1 lightning current arresters are used. In case of spark-gap-based type 1 arresters, in contrast, virtually the total current flows through the type 1 arrester. Similar to a wave breaker the energy is reduced to an acceptable level. The advantage is that the time to half value of the 10/350  $\mu$ s impulse current is reduced due to the reduction of the impulse time and the switching behaviour of type 1 SPDs. This considerably relieves downstream SPDs.





All devices of the DEHN + SÖHNE Red/Line and Yellow/Line product family are energy-coordinated. Moreover, all type 1 arresters of the Red/Line family are based on spark gaps and thus feature this WAVE BRAKER FUNCTION.







### Yellow/Line SPD class

All DEHN arresters for use in information technology systems are categorised into a Yellow/Line SPD class and are marked with the corresponding symbol in the datasheet and on the rating plate (see page 118).

## Definition of Symbols

Symbol	Definition
	Installation instructions, see <a href="http://www.dehn-international.com">www.dehn-international.com</a> ⇒ Find a Product /  More
	New Products

Symbol	Definition	Red   Line®
	<b>Integrated backup fuse</b> Reduced space requirements, lower installation costs, faster wiring and shorter connecting cable lengths are clear advantages of this concept used for the DEHNvenCI, DEHNbloc Maxi S, DEHNguard ... CI and V(A) NH product series.	
	<b>SCI technology</b> The patented SCI technology with active arc extinction allows to actively, quickly and safely extinguish a possible switching arc in case of overload. The PV fuse integrated in the short-circuit path trips immediately after the arc has been extinguished, thus ensuring safe electrical isolation (Interruption). Consequently, all PV arresters from DEHN combine surge protection, fire protection and personal protection in a single device.	
	<b>Wave breaker function</b> If a spark-gap-based type 1 arrester is used, the total current flows through the type 1 arrester during the discharge process. Similar to a wave breaker, the energy is mitigated to a sufficiently low level, thus considerably relieving downstream SPDs. The WAVE BREAKER function is integrated in all spark-gap-based type 1 arresters of the Red   Line series.	
	<b>Direct Current Disconnection</b> When using surge arresters in d.c. applications, disconnection must be reliably ensured even if there are no zero crossings. The specifically developed DC Disconnection (DCD) acts as a wedge similar to a blocking valve and interrupts the direct current. Consequently, the devices of the DEHNguard SE DC series are capable of safely interrupting direct currents, thus preventing fire damage caused by d.c. switching arcs.	

Symbol	Definition	Yellow   Line
	<b>LifeCheck®</b> LifeCheck allows to easily and quickly test arresters for information technology systems. It permanently monitors the condition of the arrester and detects electrical and thermal load on all protection components.	
	<b>actiVsense®</b> Arrester technology for arresters for information technology systems. actiVsense automatically detects the signal voltage applied and optimally adapts the voltage protection level to it. Thus, the arrester can be universally used for different interfaces and always provides maximum protection for the connected devices and system circuits in case of failure.	
<b>TYPE 1</b>	<b>Discharge capacity of an SPD</b> (according to the categories from IEC 61643-21 / EN 61643-21) Impulse D1 (10/350), lightning impulse current $\geq 2.5$ kA / line or $\geq 5$ kA / total • exceeds the discharge capacity of <b>TYPE 2</b> – <b>TYPE 4</b>	
<b>TYPE 2</b>	Impulse C2 (8/20), increased impulse load $\geq 2.5$ kA / line or $\geq 5$ kA / total • exceeds the discharge capacity of <b>TYPE 3</b> – <b>TYPE 4</b>	
<b>TYPE 3</b>	Impulse C1 (8/20), impulse load $\geq 0.25$ kA / line or $\geq 0.5$ kA / total • exceeds the discharge capacity of <b>TYPE 4</b>	
<b>TYPE 4</b>	Load < <b>TYPE 3</b>	
<b>P1</b>	<b>Protective effect of an SPD</b> (limitation below the test levels according to EN 61000-4-5) Required test level of the terminal device: 1 or higher	
<b>P2</b>	Required test level of the terminal device: 2 or higher	
<b>P3</b>	Required test level of the terminal device: 3 or higher	
<b>P4</b>	Required test level of the terminal device: 4	
	<b>Energy coordination</b> (with another Yellow   Line SPD) SPD with decoupling impedance, suitable for coordination with an SPD marked with 	
	SPD is suitable for coordination with an SPD with decoupling impedance 	

**Practice-oriented – Professional – User-friendly**

Find the right product quickly and easily with the help of our surge protection assistants (power supply systems, information technology systems).

The new DEHNselect SPD software module allows to define and select all necessary internal lightning protection and surge protection products. It creates a structure plan with a bill of materials and allows fast online access to all documents for the products selected such as data sheets and installation instructions.



DEHNselect SPD can be easily used without special knowledge or training. The user-friendly surface facilitates operating the program.

This electronic planning and selection aid provides easy and practice-oriented support for e.g. designers, electricians and installers of lightning protection systems, thus making it considerably easier to professionally implement a surge protection concept.

For more detailed information, see brochure DS 709 E (DEHNSupport Tool-box) or visit [www.dehn-international.com/en/selection-guides-and-configurators](http://www.dehn-international.com/en/selection-guides-and-configurators).

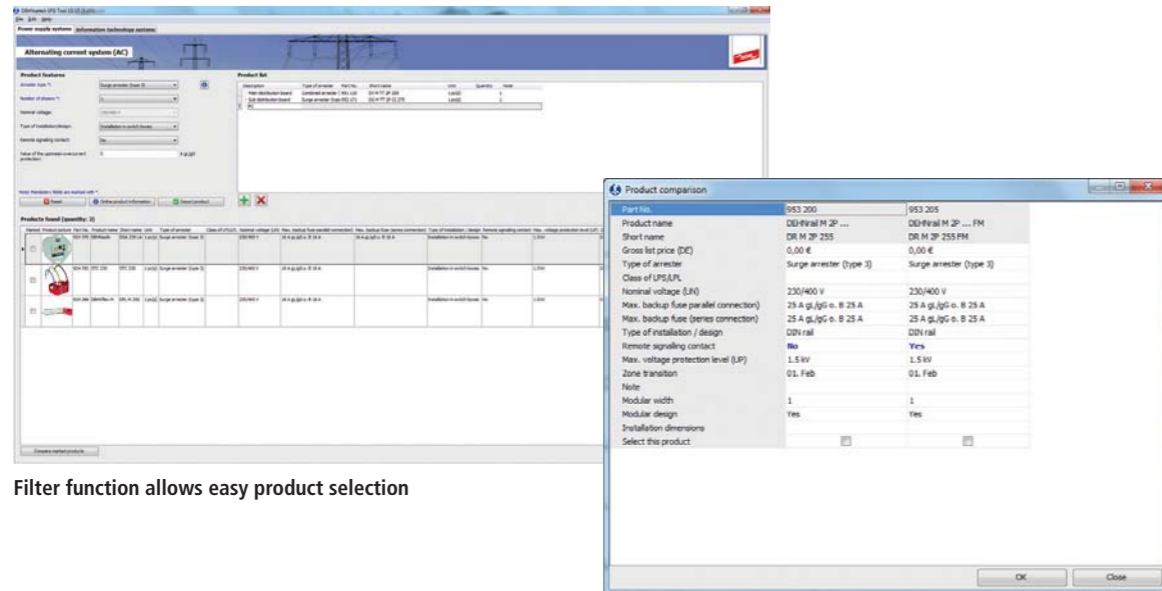

Filter function allows easy product selection

Product comparison

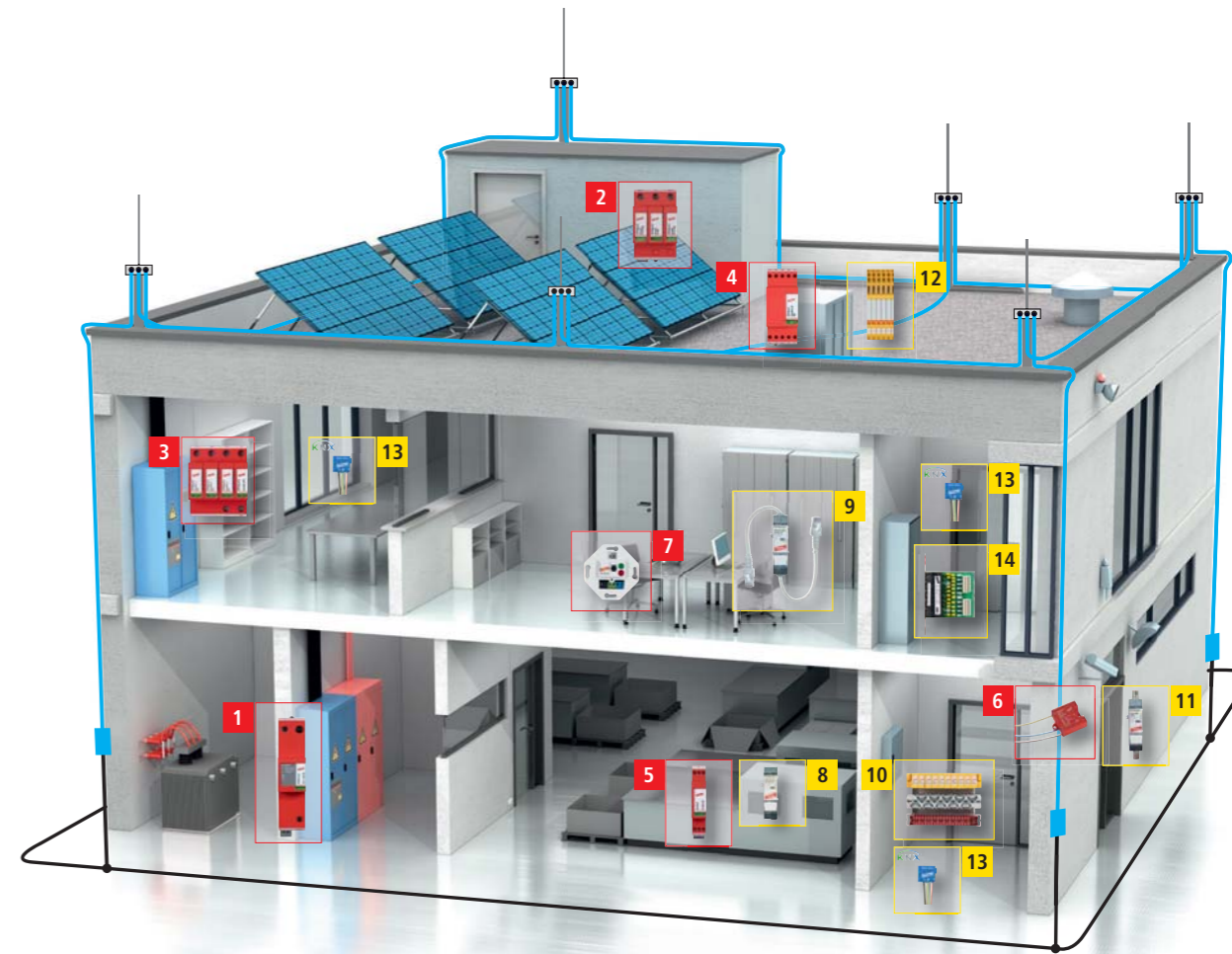

3.4 Bills of material

Power supply systems

Description	Part No.	Short name	Unit	Quantity
Main distribution board	961 205	DVCI 1 255 FM	1 pc.	1
Sub distribution board Central	952 327	DG M TT CI 275 FM	1 pc.	1
Sub distribution board Basement 1	952 327	DG M TT CI 275 FM	1 pc.	1
E-stator fan base	941 119	DSH TT 2P 255	1 pc.	1
Air conditioner roof	952 315	DG M TT CI 275 FM	1 pc.	1
Sub distribution board Ground-floor	952 327	DG M TT CI 275 FM	1 pc.	1
E-stator fan base	900 430	DCOR L 2P 275	1 pc.	1
Sub distribution board First Floor	952 327	DG M TT CI 275 FM	1 pc.	1
PC 1 - 8	905 290	DPRO 230	1 pc.	8
PC 9 - 19	909 230	DPRO 230	1 pc.	8

Bill of materials

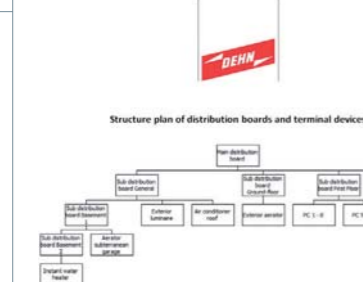

Structure plan

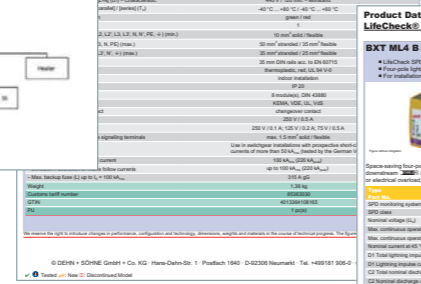
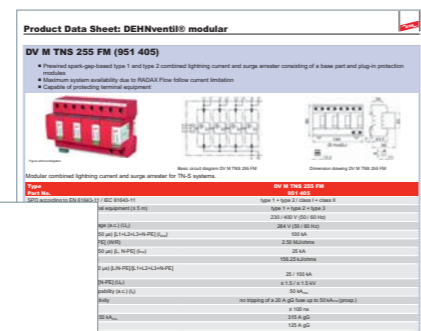

Product Data Sheet

Product Data Sheet

Position	Application (example)	Type	Part No.	Page
1	Entrance point into the building / main low-voltage distribution board	DEHNvenCI 255 FM	961 205	24
2	PV system	DEHNgard® M YPV SCI 1000 FM	952 515	70
3	Floor distributor	DEHNgard® M TNS CI 275 FM	952 406	53
4	Air-conditioning control	DEHnrail M 4P 255 FM	953 405	92
5	Production machines	DEHnrail M 2P 255 FM	953 205	91
6	Security systems	DEHncord L 2P 275	900 430	65
7	Computer workstation	DEHnsafe 230 LA	924 370	97
8	Industrial Ethernet	DEHNpatch Class E	929 121	190
9	Data network	DEHNpatch CAT6	929 100	190
10	Telecommunication system	DEHNrapid LSA	907 401	175
11	Security systems	DEHNgate BNC VCD	909 710	204
12	Air-conditioning control	DEHNconnect SD2	917 XXX	164
13	KNX bus	BUSector BT 24	925 001	196
14	Floor distributor (telecommunication)	NET PRO 10X TC1 RST	929 230	192

On the following pages you will find detailed selection tables for arresters for industrial buildings:

Surge Protection for Power Supply Systems	Page
Combined Arresters / Lightning Current Arresters – Type 1/2	18
Surge Arresters – Type 2	50
Surge Arresters – Type 3	89
Surge Protection for Information Technology Systems	Page
Easy Choice according to Interface/Signal	121



Position	Application (example)	Type	Part No.	Page
1	Entrance point into the building / main low-voltage distribution board	DEHNventil® M TNS 255 FM	951 405	21
2	Safety lighting extending beyond the building (d.c. and a.c.)	DEHNsecure M 1 242 FM	971 127	43
3	Floor distributor	DEHNguard® M TNS CI 275 FM	952 406	53
4	Air-conditioning control	DEHNrail M 4P 255 FM	953 405	92
5	Emergency lighting (d.c. and a.c.)	DEHNguard® SE DC 242 FM	972 125	68
6	Heating control	DEHNrail M 4P 255 FM	953 405	92
7	Computer workstation	NSM PRO	924 335	98
8	Shutter control	DEHNcord L 2P 275	900 430	65
9	Computer workstation	DEHNflex M 255	924 396	101
10	Air-conditioning control	BLITZDUCTOR® SP	926 244	153
11	Security systems	BLITZDUCTOR® XT	920 310	144
12	Data network	DEHNpatch CAT6	929 100	190
13	Heating control	DEHNconnect SD2	917 XXX	164
14	KNX bus	BUSector BT 24	925 001	196

On the following pages you will find detailed selection tables for arresters for office buildings:

Surge Protection for Power Supply Systems	Page
Combined Arresters / Lightning Current Arresters – Type 1/2	19
Surge Arresters – Type 2	51
Surge Arresters – Type 3	89
<b>Surge Protection for Information Technology Systems</b>	<b>Page</b>
Easy Choice according to Interface/Signal	121



Position	Application (example)	Type	Part No.	Page
1	Entrance point into the building	DEHNventil ZP® TT 255	900 391	23
2	Sub-distribution board	DEHNguard® M TNS 275	952 400	56
3	Heating control	DEHNrail M 2P 255	953 200	91
4	Satellite system	DEHNflex M 255	924 396	101
5	PV system	DEHNcube YPV SCI 1000	900 910	77
6	Telephone connection / DSL	DEHNbox TC 180	922 210	198
7	Heating sensor	BLITZDUCTOR® SP	926 244	153
8	TV connection	DEHNprotector 230 TV	909 300	194
9	Satellite system	DEHNgate GFF TV	909 705	204
10	Computer workstation	DEHNprotector 230 LAN 100	909 321	195
11	KNX bus	BUSector BT 24	925 001	196

On the following pages you will find detailed selection tables for arresters for residential buildings:

Surge Protection for Power Supply Systems	Page
Combined Arresters / Lightning Current Arresters – Type 1/2	19
Surge Arrester – Type 2	51
Surge Arrester – Type 3	89
<b>Surge Protection for Information Technology Systems</b>	<b>Page</b>
Easy Choice according to Interface/Signal	121



# Surge Protection for POWER SUPPLY SYSTEMS

SPDs for low-voltage Installations and Devices

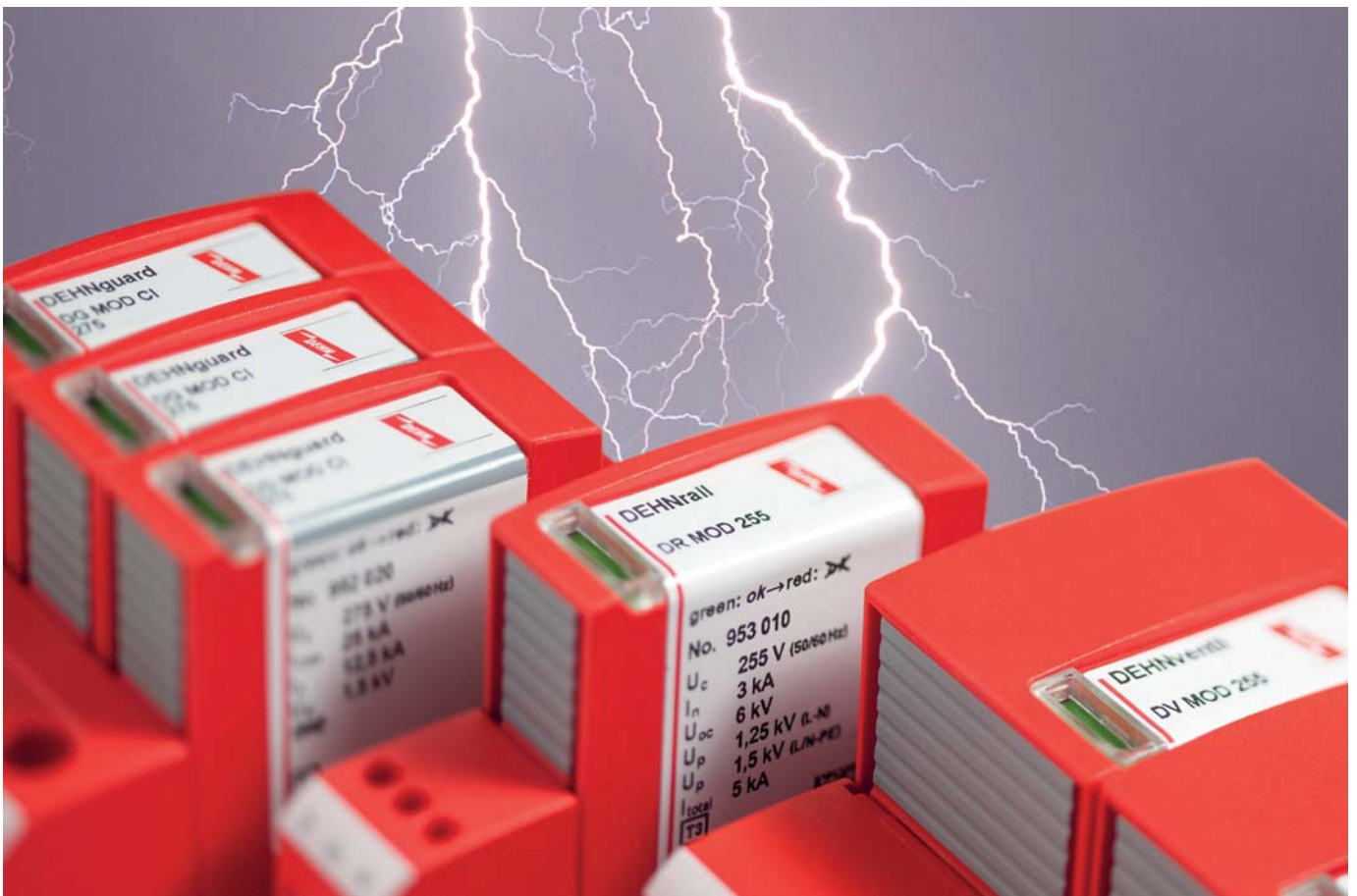

**Red / Line®**

International Power Supply Systems

International system configurations\* according to IEC 60364-1

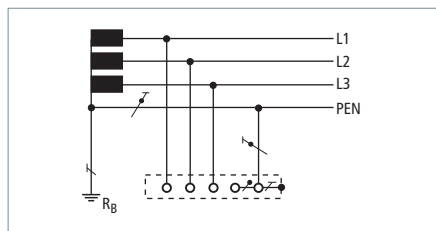

TN-C system 230 / 400 V

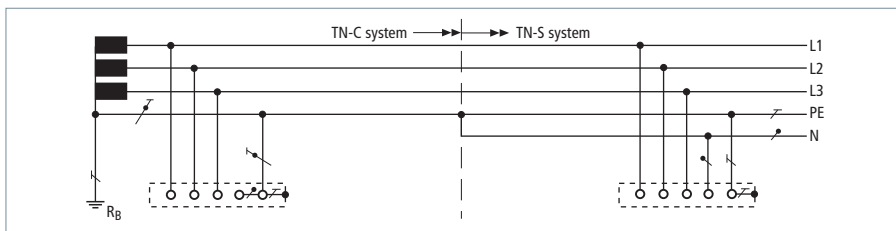

TN-C-S system 230 / 400 V

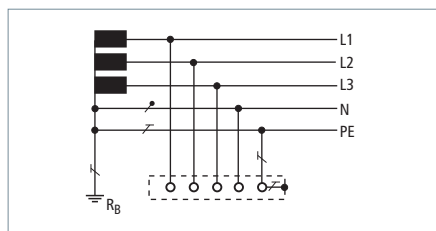

TN-S system 230 / 400 V

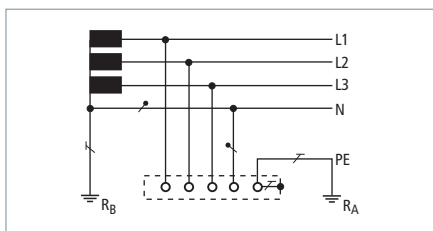

TT system 230 / 400 V

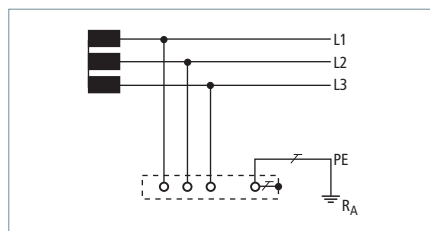

IT system 230 V

Further international system configurations\*

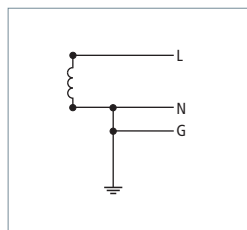

single-phase; 3 conductors

(1 Ph, 2 W + G)  
110 V  
120 V  
220 V  
240 V

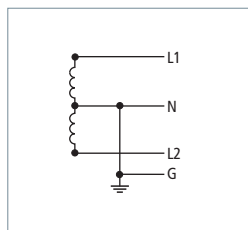

single-phase; 4 conductors  
Split Phase or Edison

(1 Ph, 3 W + G)  
120 V / 240 V

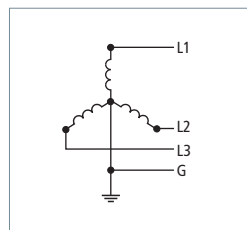

three-phase; 4 conductors

(3 Ph Y, 3 W + G)  
480 V

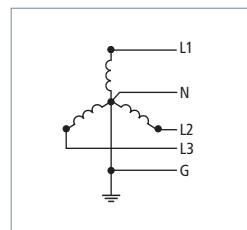

three-phase; 5 conductors

(3 Ph Y, 4 W + G)  
120 V / 208 V  
277 V / 480 V

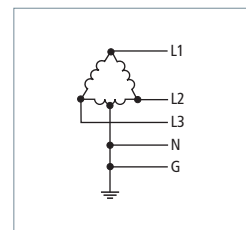

three-phase; 5 conductors  
Delta "Highleg"  
(3 Ph Δ, 4 W + G)  
120 V / 240 V

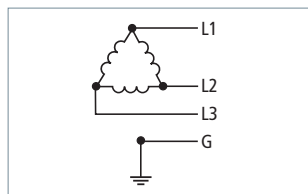

three-phase; 4 conductors  
Delta "Ungrounded"

(3 Ph Δ, 3 W + G)  
240 V  
480 V

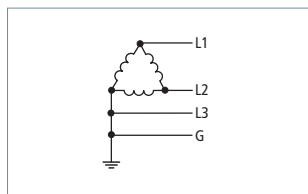

three-phase; 4 conductors  
Delta "Grounded Corner"

(3 Ph Δ, 3 W + G)  
240 V  
480 V

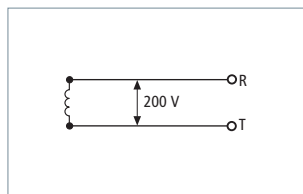

single-phase; 2 conductors

(1 Ph, 2 W)  
200 V

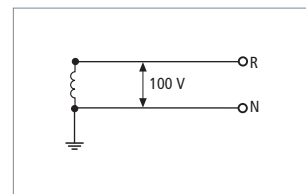

single-phase; 2 conductors

(1 Ph, 2 W)  
100 V

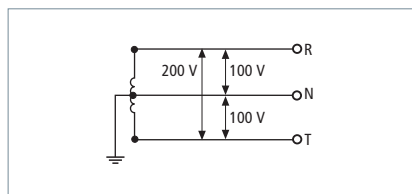

single-phase; 3 conductors  
(1 Ph, 3 W)  
100 V / 200 V

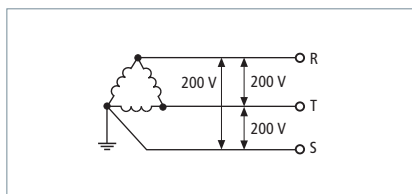

three-phase; 3 conductors  
(3 Ph, 3 W)  
200 V

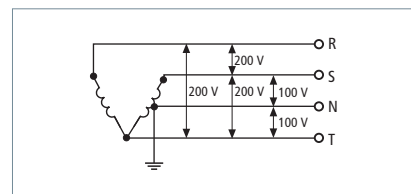

three-phase; 3 conductors + single-phase;  
3 conductors  
100 V / 200 V; 200 V

\* System according to the earth connection (according to IEC 60364-1)



**General**

16



**Combined Arresters – Type 1**

18



**Lightning Current Arresters – Type 1**

31



**N-PE Lightning Current Arresters**

47



**Surge Arresters – Type 2**

50



**Surge Arresters – Type 3**

89



**General Accessories**

105

17

Selection Chart – Industrial Building

TN-C system	TN-S system	TT system	230/400 V a.c.	400/690 V a.c.	Higher voltages (a.c.)	Integrated backup fuse	Type 1 + type 2 combined arresters (+ type 3)*	Type 1 lightning current arresters	Din rail	Busbar	d.c. applications	PV system	Remote signalling contact	Type	Part. No.	Page
3 pcs	4 pcs	3 pcs	●			●	●		●					DVCI 1 255	961 200	24
		N-PE ←	●				●		●					DGPM 1 255	961 180	48
3 pcs	4 pcs	3 pcs	●			●	●		●			●		DVCI 1 255 FM	961 205	24
		N-PE ←	●				●		●			●		DGPM 1 255 FM	961 185	48
1 pc			●				●		●					DV M TNC 255	951 300	21
1 pc			●				●		●			●		DV M TNC 255 FM	951 305	21
	1 pc		●				●		●					DV M TNS 255	951 400	21
	1 pc		●				●		●			●		DV M TNS 255 FM	951 405	21
		1 pc	●				●		●					DV M TT 255	951 310	21
		1 pc	●				●		●			●		DV M TT 255 FM	951 315	21
3 pcs	4 pcs	3 pcs	●					●	●					DB M 1 255	961 120	33
		N-PE ←	●					●	●					DGP M 255	961 101	48
3 pcs	4 pcs	3 pcs	●					●	●			●		DB M 1 255 FM	961 125	33
		N-PE ←	●					●	●			●		DGP M 255 FM	961 105	48
3 pcs	4 pcs	3 pcs	●			●		●		●		910 631		DBM 1 255 S	900 220	39
		N-PE ←	●					●		●		910 631		DGPM 1 255 S	900 050	48
3 pcs	4 pcs	3 pcs		●		●		●	●			●		DBM 1 CI 440 FM	961 146	36
3 pcs	4 pcs	3 pcs		●				●	●			●		DBM 1 440 FM	961 145	38
		N-PE ←		●				●	●			●		DGPM 440 FM	961 165	48
3 pcs	4 pcs	3 pcs		●				●	●					DBM 1 440	961 140	38
		N-PE ←		●				●	●					DGPM 440	961 160	48
3 pcs	4 pcs				●	●		●	●			●		DBM 1 CI 760 FM	961 176	36
3 pcs	4 pcs				●			●	●			●		DBM 1 760 FM	961 175	38
								●	●		●			DSE M 1 242	971 122	43
								●	●		●			DSE M 1 242 FM	971 127	43
							●		●		●			DCB YPV SCI 1000	900 061	29
							●		●		●			DCB YPV SCI 1000 FM	900 066	29

\* Energy coordination with terminal equipment (≤ 5 m)

Selection Chart – Office Building

TN-C system	TN-S system	TT system	Integrated backup fuse	Type 1 + type 2 combined arresters (+ type 3)*	Type 1 lightning current arresters	Din rail	Busbar	d.c. applications	Remote signalling contact	Type	Part No.	Page
3 pcs	4 pcs	3 pcs 1 pc	•	•		•				DVCI 1 255	961 200	24
				•		•				DGPM 1 255	961 180	48
3 pcs	4 pcs	3 pcs 1 pc	•	•		•		•		DVCI 1 255 FM	961 205	24
				•		•		•		DGPM 1 255 FM	961 185	48
1 pc				•		•				DV M TNC 255	951 300	21
1 pc				•		•		•		DV M TNC 255 FM	951 305	21
	1 pc			•		•				DV M TNS 255	951 400	21
	1 pc			•		•		•		DV M TNS 255 FM	951 405	21
		1 pc		•		•				DV M TT 255	951 310	21
		1 pc		•		•		•		DV M TT 255 FM	951 315	21
3 pcs	4 pcs	3 pcs 1 pc			•	•				DB M 1 255	961 120	33
					•	•				DGP M 255	961 101	48
3 pcs	4 pcs	3 pcs 1 pc			•	•		•		DB M 1 255 FM	961 125	33
					•	•		•		DGP M 255 FM	961 105	48
3 pcs	4 pcs	3 pcs 1 pc	•		•		•	910 631		DBM 1 255 S	900 220	37
			•		•		•	910 631		DGPM 1 255 S	900 050	48
				•		•		•		DSE M 1 242	971 122	43
				•		•		•	•	DSE M 1 242 FM	971 127	43

\* Energy coordination with terminal equipment (≤ 5 m)

Selection Chart – Residential Building

TN-C system	TN-S system	TT system	Type 1 + type 2 combined arresters (+ type 3)*	Type 1 lightning current arresters	DIN rail	Busbar 40 mm	PV system	Remote signalling contact	Type	Part No.	Page
1 pc			•			•			DV ZP TNC 255	900 390	23
	1 pc	1 pc	•			•			DV ZP TT 255	900 391	23
1 pc			•		•				DSH TNC 255	941 300	26
1 pc			•		•			•	DSH TNC 255 FM	941 305	26
	1 pc		•		•				DSH TNS 255	941 400	26
	1 pc		•		•			•	DSH TNS 255 FM	941 405	26
		1 pc	•		•				DSH TT 255	941 310	26
		1 pc	•		•			•	DSH TT 255 FM	941 315	27
3 pcs	4 pcs	3 pcs N-PE		•	•				DB M 1 255	961 120	33
				•	•				DGP M 255	961 101	48
3 pcs	4 pcs	3 pcs N-PE		•	•			•	DB M 1 255 FM	961 125	33
				•	•			•	DGP M 255 FM	961 105	48
			•		•		•		DCB YPV SCI 1000	900 061	29
			•		•		•	•	DCB YPV SCI 1000 FM	900 066	29

\* Energy coordination with terminal equipment (≤ 5 m)

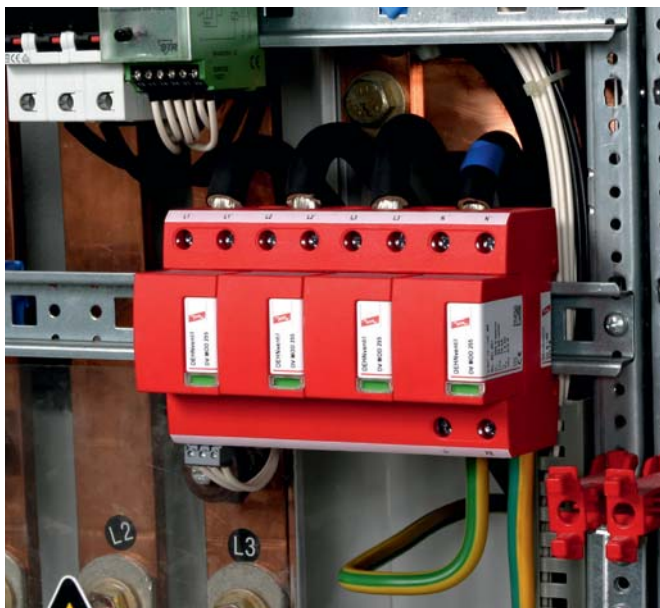
**DEHNventil® modular**

For protecting low-voltage consumer's installations against surges and even direct lightning strikes. For installation in conformity with the lightning protection zone concept at the boundaries from  $0_A - 2$ .

- Prewired spark-gap-based type 1 and type 2 combined lightning current and surge arrester consisting of a base part and plug-in protection modules
- Maximum system availability due to RADAX Flow follow current limitation
- No tripping of 20 A gG fuses up to short-circuit currents of  $50 \text{ kA}_{\text{rms}}$
- Discharge capacity up to 100 kA (10/350  $\mu\text{s}$ )
- Capable of protecting terminal equipment
- Operating state / fault indication by green / red indicator flag in the inspection window
- Easy replacement of protection modules without tools due to module locking system with module release button
- Vibration and shock-tested according to EN 60068-2

<b>DEHNventil M TNC 255:</b>	<b>Modular combined lightning current and surge arrester for use in TN-C systems</b>
<b>DEHNventil M TNS 255:</b>	<b>Modular combined lightning current and surge arrester for use in TN-S systems</b>
<b>DEHNventil M TT 255:</b>	<b>Modular combined lightning current and surge arrester for use in TT and TN-S systems ("3+1" circuit)</b>
<b>DEHNventil M TN 255:</b>	<b>Modular combined lightning current and surge arrester for use in single-phase TN systems</b>
<b>DEHNventil M TT 2P 255:</b>	<b>Modular combined lightning current and surge arrester for use in single-phase TT and TN systems ("1+1" circuit)</b>
<b>DEHNventil M ... FM:</b>	<b>With remote signalling contact for monitoring device (floating changeover contact)</b>

With their functional Red/Line design, the devices of the modular DEHNventil family provide a combination of safety and innovation. Designed for "all-in-one installation", the arresters integrate lightning equipotential bonding and surge protection in a single device, making them ideal for use in compact electrical installations. The energy-coordinated arresters even allow to protect terminal equipment if the distance between DEHNventil and the loads is  $\leq 5 \text{ m}$ . With a lightning current discharge capacity up to 100,000 A, the arresters ensure a high degree of availability of the electrical installation to be protected. Even in large-scale electrical installations, the modular DEHNventil arresters provide various application benefits. The Red/Line surge arresters installed at the boundaries of the individual lightning protection zones, for example, are already energy-coordinated with the DEHNventil arresters. Encapsulated creepage discharge spark gaps and the small space requirements enable easy integration into switchgear installations or distribution boards. A special feature of the modular DEHNventil family is its functional design, in particular the module locking system. It fixes the protection module firmly in place so that it is safely connected to the base part even with maximum loads. If a protection module has to be replaced, it releases the module without tools and allows easy removal. By using the

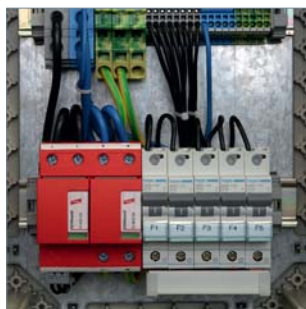

double terminals suitable for all conductors, the arresters can be connected in series in a space-saving and cost-effective way up to nominal currents of 125 A as preferred by IEC 60364-5-53. Busbars of type MVS 3 8 6 and MVS 4 11 8 can be used for connecting further DIN rail mounted devices. The type designation of DEHNventil arresters allows to easily choose the right arrester for the relevant system configuration of the low-voltage consumer's installation.

The patented RADAX Flow technology for follow current limitation and extinction allows high availability of the electrical consumer's installation to be protected. Even in case of short-circuit currents as high as  $100 \text{ kA}_{\text{rms}}$ , mains follow currents are reduced in such a way that selectivity with respect to low-current-rated fuses is ensured. This means that upstream fuses will not trip due to upcoming mains follow currents.

The operating state / fault indicator of each protective path needs no power to operate and instantly shows the operating state of the surge arrester. Apart from the standard visual indicator with green and red indicator flags, DEHNventil M ... FM devices feature a three-pole remote signalling terminal. With its floating changeover contact, the remote signal can be used as a break or make contact according to the particular circuit concept.

Due to their parameters and design, the devices can be even installed even upstream of meter panels in low-voltage consumer's installations.

### DEHNventil M TNC (FM)

Modular combined lightning current and surge arrester for TN-C systems with a nominal voltage of 230 / 400 V ("3-0" circuit); FM version with floating remote signalling contact.

Type DV M ...	TNC 255	TNC 255 FM
Part No.	951 300	951 305
SPD according to EN 61643-11 / IEC 61643-11	type 1 + type 2 / class I + class II	type 1 + type 2 / class I + class II
Max. continuous operating voltage (a.c.) ( $U_c$ )	264 V (50 / 60 Hz)	264 V (50 / 60 Hz)
Lightning impulse current (10/350 $\mu$ s) [L1+L2+L3-PEN] ( $I_{total}$ )	75 kA	75 kA
Lightning impulse current (10/350 $\mu$ s) [L-PEN] ( $I_{imp}$ )	25 kA	25 kA
Voltage protection level ( $U_p$ )	$\leq 1.5$ kV	$\leq 1.5$ kV
Max. backup fuse (L) up to $I_K = 50$ kA <sub>rms</sub>	315 A gG	315 A gG
Approvals	KEMA, VDE, UL, VdS	KEMA, VDE, UL, VdS
Type of remote signalling contact	—	changeover contact
<b>Extended technical data:</b>	<b>For use in switchgear installations with prospective short-circuit currents of more than 50 kA<sub>rms</sub> (tested by the German VDE)</b>	
– Max. prospective short-circuit current	100 kA <sub>rms</sub> (220 kA <sub>peak</sub> )	100 kA <sub>rms</sub> (220 kA <sub>peak</sub> )



### DEHNventil M TNS (FM)

Modular combined lightning current and surge arrester for TN-S systems with a nominal voltage of 230 / 400 V ("4-0" circuit); FM version with floating remote signalling contact.

Type DV M ...	TNS 255	TNS 255 FM
Part No.	951 400	951 405
SPD according to EN 61643-11 / IEC 61643-11	type 1 + type 2 / class I + class II	type 1 + type 2 / class I + class II
Max. continuous operating voltage (a.c.) ( $U_c$ )	264 V (50 / 60 Hz)	264 V (50 / 60 Hz)
Lightning impulse current (10/350 $\mu$ s) [L1+L2+L3+N-PE] ( $I_{total}$ )	100 kA	100 kA
Lightning impulse current (10/350 $\mu$ s) [L, N-PE] ( $I_{imp}$ )	25 kA	25 kA
Voltage protection level [L-PE]/[N-PE] ( $U_p$ )	$\leq 1.5 / \leq 1.5$ kV	$\leq 1.5 / \leq 1.5$ kV
Max. backup fuse (L) up to $I_K = 50$ kA <sub>rms</sub>	315 A gG	315 A gG
Approvals	KEMA, VDE, UL, VdS	KEMA, VDE, UL, VdS
Type of remote signalling contact	—	changeover contact
<b>Extended technical data:</b>	<b>For use in switchgear installations with prospective short-circuit currents of more than 50 kA<sub>rms</sub> (tested by the German VDE)</b>	
– Max. prospective short-circuit current	100 kA <sub>rms</sub> (220 kA <sub>peak</sub> )	100 kA <sub>rms</sub> (220 kA <sub>peak</sub> )



### DEHNventil M TT (FM)

Modular combined lightning current and surge arrester for TT and TN-S systems with a nominal voltage of 230 / 400 V ("3+1" circuit); FM version with floating remote signalling contact.

Type DV M ...	TT 255	TT 255 FM
Part No.	951 310	951 315
SPD according to EN 61643-11 / IEC 61643-11	type 1 + type 2 / class I + class II	type 1 + type 2 / class I + class II
Max. continuous operating voltage (a.c.) [L-N] ( $U_c$ )	264 V (50 / 60 Hz)	264 V (50 / 60 Hz)
Lightning impulse current (10/350 $\mu$ s) [L1+L2+L3+N-PE] ( $I_{total}$ )	100 kA	100 kA
Lightning impulse current (10/350 $\mu$ s) [L-N]/[N-PE] ( $I_{imp}$ )	25 / 100 kA	25 / 100 kA
Voltage protection level [L-N]/[N-PE] ( $U_p$ )	$\leq 1.5 / \leq 1.5$ kV	$\leq 1.5 / \leq 1.5$ kV
Max. backup fuse (L) up to $I_K = 50$ kA <sub>rms</sub>	315 A gG	315 A gG
Approvals	KEMA, VDE, UL, VdS	KEMA, VDE, UL, VdS
Type of remote signalling contact	—	changeover contact
<b>Extended technical data:</b>	<b>For use in switchgear installations with prospective short-circuit currents of more than 50 kA<sub>rms</sub> (tested by the German VDE)</b>	
– Max. prospective short-circuit current	100 kA <sub>rms</sub> (220 kA <sub>peak</sub> )	100 kA <sub>rms</sub> (220 kA <sub>peak</sub> )



### DEHNventil M TN (FM)

Modular combined lightning current and surge arrester for single-phase TN systems with a nominal voltage of 230 V ("2-0" circuit); FM version with floating remote signalling contact.

Type DV M ...	TN 255	TN 255 FM
Part No.	951 200	951 205
SPD according to EN 61643-11 / IEC 61643-11	type 1 + type 2 / class I + class II	type 1 + type 2 / class I + class II
Max. continuous operating voltage (a.c.) ( $U_c$ )	264 V (50 / 60 Hz)	264 V (50 / 60 Hz)
Lightning impulse current (10/350 $\mu$ s) [L+N-PE] ( $I_{total}$ )	50 kA	50 kA
Lightning impulse current (10/350 $\mu$ s) [L, N-PE] ( $I_{imp}$ )	25 kA	25 kA
Voltage protection level [L-PE]/[N-PE] ( $U_p$ )	$\leq 1.5 / \leq 1.5$ kV	$\leq 1.5 / \leq 1.5$ kV
Max. backup fuse (L) up to $I_K = 50$ kA <sub>rms</sub>	315 A gG	315 A gG
Approvals	KEMA, VDE, UL, VdS	KEMA, VDE, UL, VdS
Type of remote signalling contact	—	changeover contact
<b>Extended technical data:</b>	<b>For use in switchgear installations with prospective short-circuit currents of more than 50 kA<sub>rms</sub> (tested by the German VDE)</b>	
– Max. prospective short-circuit current	100 kA <sub>rms</sub> (220 kA <sub>peak</sub> )	100 kA <sub>rms</sub> (220 kA <sub>peak</sub> )



**DEHNventil M TT 2P (FM)**

Modular combined lightning current and surge arrester for single-phase TT and TN systems with a nominal voltage of 230 V ("1+1" circuit); FM version with floating remote signalling contact.



Type DV M ...	TT 2P 255	TT 2P 255 FM
Part No.	951 110	951 115
SPD according to EN 61643-11 / IEC 61643-11	type 1 + type 2 / class I + class II	type 1 + type 2 / class I + class II
Max. continuous operating voltage (a.c.) [L-N] ( $U_c$ )	264 V (50 / 60 Hz)	264 V (50 / 60 Hz)
Lightning impulse current (10/350 $\mu$ s) [L+N-PE] ( $I_{total}$ )	50 kA	50 kA
Lightning impulse current (10/350 $\mu$ s) [L-N]/[N-PE] ( $I_{imp}$ )	25 / 50 kA	25 / 50 kA
Voltage protection level [L-N]/[N-PE] ( $U_p$ )	$\leq 1.5 / \leq 1.5$ kV	$\leq 1.5 / \leq 1.5$ kV
Max. backup fuse (L) up to $I_k = 50$ kA <sub>rms</sub>	315 A gG	315 A gG
Approvals	KEMA, VDE, UL, VdS	KEMA, VDE, UL, VdS
Type of remote signalling contact	—	changeover contact
<b>Extended technical data:</b>	<b>For use in switchgear installations with prospective short-circuit currents of more than 50 kA<sub>rms</sub> (tested by the German VDE)</b>	
– Max. prospective short-circuit current	100 kA <sub>rms</sub> (220 kA <sub>peak</sub> )	100 kA <sub>rms</sub> (220 kA <sub>peak</sub> )



**Protection Module for DEHNventil® modular**

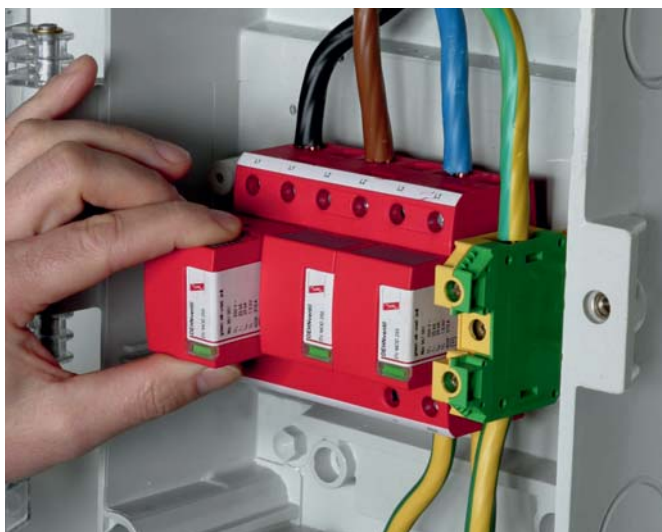

- High discharge capacity due to powerful creepage discharge spark gap
- Maximum system availability due to RADAX Flow follow current limitation
- Easy replacement of protection modules without tools due to module locking system with module release button
- Operating state / fault indication by green / red indicator flag in the inspection window
- The plug-in protection module can be replaced without the need to de-energise and without removing the distribution board cover

For protecting low-voltage consumer's installations against surges and even direct lightning strikes. For installation in conformity with the lightning protection zone concept at the boundaries from  $O_A - 2$ .

- DV MOD 255: Spark-gap-based protection module
- DV MOD NPE 50: 50 kA N-PE spark-gap-based protection module
- DV MOD NPE 100: 100 kA N-PE spark-gap-based protection module

The spark-gap-based protection modules of the modular DEHNventil series combine safety and innovation in a single device. Apart from the encapsulated RADAX Flow spark gap technology, the compact protection modules incorporate the complete monitoring circuit for controlling the energy flow of the spark gap, the monitoring device and the operating state / fault indicator.

The mechanical coding of the protection module prevents that the N-PE protection modules are confused with the spark-gap-based module for the phase conductors. The module locking mechanism fixes the protection modules to the base part. Protection modules can be easily removed without tools by simply pressing the module release button.

**Spark-Gap-Based Protection Module**

Spark-gap-based protection module for DEHNventil M ...



Type DV MOD ...	255
Part No.	951 001
Max. continuous operating voltage (a.c.) ( $U_c$ )	264 V
Lightning impulse current (10/350 $\mu$ s) ( $I_{imp}$ )	25 kA

**N-PE Spark-Gap-Based Protection Module**

N-PE spark-gap-based protection module for DEHNventil M with "... + 1" circuit



Type DV MOD ...	NPE 50	NPE 100
Part No.	951 050	951 100
Max. continuous operating voltage (a.c.) ( $U_c$ )	255 V	255 V
Lightning impulse current (10/350 $\mu$ s) ( $I_{imp}$ )	50 kA	100 kA



**DEHNventil® ZP**

- Type 1 and type 2 combined lightning current and surge arrester with RADAX Flow spark gap technology
- Fully compliant with all requirements of the national VDN\* guideline on the use of SPDs upstream of the meter panel
- Quick and easy installation by snapping the arrester onto 40 mm busbar systems
- Test for correct operation by pressing the button with indicator light
- No tripping of 32 A gG fuses up to short-circuit currents of 25 kA<sub>rms</sub>
- Discharge capacity up to 100 kA (10/350 μs)
- Capable of protecting terminal equipment
- Maximum system availability

**DEHNventil ZP TNC 255:** Three-pole combined lightning current and surge arrester for TN-C systems for use in primary power systems

**DEHNventil ZP TT 255:** Four-pole combined lightning current and surge arrester for TT and TN-S systems for use in primary power systems

DEHNventil ZP combined lightning current and surge arresters are specifically designed for installation in the busbar connection panels of meter panels. They can be directly snapped onto the busbar system without tools. Their compact dimensions leave enough space for the connecting cable from the service entrance box, even if three selective main circuit breakers are installed. The operating state of the arresters is indicated by an indicator light at the push of a button. Both due to this kind of operating state indication and their design as a spark-gap-based arrester, DEHNventil ZP arresters have no leakage and operating currents.

The RADAX Flow spark gap technology ensures the required disconnection selectivity for follow currents even in case of low-current-rated fuses in the service entrance box. Undesirable supply interruptions due to tripped main fuses are thus avoided.

The dimensioning of the arrester parameters as well as the complete arrester concept are fully compliant with all requirements of the German VDN guideline\* on the use of surge protective devices in primary power systems.

\* VDN ... Verband der Netzbetreiber VDN e. V. beim BDEW  
[Association of German Network Operators VDN e. V. at the BDEW in Germany]



For protecting low-voltage consumer's installations against surges and even direct lightning strikes. For installation in conformity with the lightning protection zone concept at the boundaries from 0<sub>A</sub> – 2.

**DEHNventil ZP TNC**

Complete circuit for TN-C systems for use in primary power systems with a nominal voltage of 230 / 400 V ("3-0" circuit).

Type DV ZP ...	TNC 255
Part No.	900 390
SPD according to EN 61643-11 / IEC 61643-11	type 1 + type 2 / class I + class II
Max. continuous operating voltage (a.c.) (U <sub>c</sub> )	255 V (50 / 60 Hz)
Lightning impulse current (10/350 μs) [L1+L2+L3-PEN] (I <sub>total</sub> )	75 kA
Lightning impulse current (10/350 μs) [L-PEN] (I <sub>imp</sub> )	25 kA
Voltage protection level (U <sub>p</sub> )	≤ 1.5 kV
Max. backup fuse up to I <sub>k</sub> = 25 kA <sub>rms</sub>	315 A gG
Approvals	VDE



**DEHNventil ZP TT**

Complete circuit for TT and TN-S systems for use in primary power systems with a nominal voltage of 230 / 400 V ("3+1" circuit).

Type DV ZP ...	TT 255
Part No.	900 391
SPD according to EN 61643-11 / IEC 61643-11	type 1 + type 2 / class I + class II
Max. continuous operating voltage (a.c.) (U <sub>c</sub> )	255 V (50 / 60 Hz)
Lightning impulse current (10/350 μs) [L1+L2+L3+N-PE] (I <sub>total</sub> )	100 kA
Lightning impulse current (10/350 μs) [L-N] (I <sub>imp</sub> )	25 kA
Lightning impulse current (10/350 μs) [N-PE] (I <sub>imp</sub> )	100 kA
Voltage protection level [L-N] (U <sub>p</sub> )	≤ 1.5 kV
Voltage protection level [N-PE] (U <sub>p</sub> )	≤ 1.5 kV
Max. backup fuse up to I <sub>k</sub> = 25 kA <sub>rms</sub>	315 A gG
Approvals	VDE





DEHNvenCI



For protecting low-voltage consumer's installations against surges and even direct lightning strikes. For installation in conformity with the lightning protection zone concept at the boundaries from  $0_A - 2$ .

Featuring the functional Red/Line family design, coordinated DEHNvenCI combined lightning current and surge arresters provide maximum system protection and take up little space. The features of the practice-proven DEHNventil family were combined with a lightning current carrying arrester backup fuse in an enclosure with a width of only two modules. With switchgear installations getting more and more compact, it is difficult to install lightning current arresters in conformity with the standard. DEHNvenCI arresters allow space-saving integration of a combined lightning current and surge arrester and are said to meet the protection requirements of modern switchgear installations. The integrated arrester backup fuse is dimensioned to ensure maximum discharge capacity and optimal system protection. The need to select and install an arrester backup fuse is eliminated, ensuring short connecting cable lengths as required in IEC 60364-5-53. Consequently, DEHNvenCI is an efficient combined arrester which is easy to install. The energy-coordinated arresters even allow protection of terminal devices or sensitive electronic systems in modern switchgear installations if the distance between DEHNvenCI and the loads is  $\leq 5$  m.

- Spark-gap based combined lightning current and surge arrester with integrated backup fuse
- Energy coordination with other arresters of the Red/Line product family
- Low voltage protection level  $U_p \leq 1.5$  kV (including backup fuse)
- Maximum system availability due to RADAX Flow follow current limitation
- Extinction of mains follow currents up to  $100 \text{ kA}_{\text{rms}}$
- High lightning current discharge capacity of 25 kA (10/350  $\mu\text{s}$ )
- Capable of protecting terminal equipment
- Operating state / fault indication by green / red indicator flag in the inspection window

- DEHNvenCI 1 255: Single-pole combined lightning current and surge arrester with integrated backup fuse
- DEHNvenCI 1 255 FM: With remote signalling contact for monitoring device (floating changeover contact)

The patented RADAX Flow technology for follow current limitation and extinction allows high availability of the electrical consumer's installation to be protected.

Even in case of short-circuit currents as high as  $100 \text{ kA}_{\text{rms}}$ , DEHNvenCI can be used in industrial systems without restrictions.

The ability to carry lightning impulse currents without destruction and simultaneously reduce the energy to an acceptable level for terminal devices ensures the availability of the switchgear installation in case of a lightning strike. This considerably reduces the risk of high-loss failures.

The operating state / fault indicator of DEHNvenCI, which houses the fuse monitoring system and needs no power to operate, shows the operating state of the arrester. Apart from the standard visual indicator with green and red indicator flags, DEHNvenCI 1 255 FM devices feature a three-pole remote signalling terminal. With its floating changeover contact, the remote signal can be used as a break or make contact according to the particular circuit concept.

DEHNvenCI 255 (FM)

Single-pole combined lightning current and surge arrester with integrated backup fuse for use in 230 / 400 V systems; FM version with floating remote signalling contact.



Type DVCI 1 ...	255	255 FM
Part No.	961 200	961 205
SPD according to EN 61643-11 / IEC 61643-11	type 1 / class I	type 1 / class I
Maximum continuous operating voltage (a.c.) ( $U_c$ )	255 V (50 / 60 Hz)	255 V (50 / 60 Hz)
Lightning impulse current (10/350 $\mu\text{s}$ ) ( $I_{\text{imp}}$ )	25 kA	25 kA
Voltage protection level ( $U_p$ )	$\leq 1.5$ kV	$\leq 1.5$ kV
Max. mains-side overcurrent protection	not required	not required
Approvals	KEMA	KEMA
Type of remote signalling contact	—	changeover contact
<b>Extended technical data:</b>	<b>For use in installations with prospective short-circuit currents of more than <math>50 \text{ kA}_{\text{rms}}</math> (tested by the German VDE)</b>	
– Max. prospective short-circuit current	$100 \text{ kA}_{\text{rms}}$ ( $220 \text{ kA}_{\text{peak}}$ )	$100 \text{ kA}_{\text{rms}}$ ( $220 \text{ kA}_{\text{peak}}$ )

Accessories for DEHNvenCI

Earthing Clip for two-module Enclosures, single-phase, three-pole / four-pole

Earthing clip for connecting the earth terminal of e.g. three/four type 1 SPDs with two-module enclosure and terminal to earth.



Type	EB DG 1000 1 3	EB 1 4 9
Part No.	900 411	900 417
Dimensions	34 x 112 x 28 mm	34 x 148 x 28 mm
Clamp	up to $25 \text{ mm}^2$	up to $25 \text{ mm}^2$

**DEHNshield®**

- Application-optimised and prewired spark-gap-based type 1 and type 2 combined lightning current and surge arrester
- Compact and space-saving design due to spark gap technology without venting means with a width of only 1 module / pole
- Fulfils the minimum requirements on the lightning current discharge capacity according to IEC 60364-5-53
- Allows compact lightning equipotential bonding including protection of terminal equipment
- Discharge capacity up to 50 kA (10/350  $\mu$ s)
- Operating state / fault indication by green / red indicator flag in the inspection window
- High follow current extinguishing capacity ( $I_{fi} = 25 \text{ kA}_{rms}$ )



For protecting compact low-voltage consumer's installations against surges and even direct lightning strikes. For installation in conformity with the lightning protection zone concept at the boundaries from  $O_A - 2$ .

- DEHNshield TNC 255: Application-optimised combined lightning current and surge arrester for TN-C systems  
 DEHNshield TNS 255: Application-optimised combined lightning current and surge arrester for TN-S systems  
 DEHNshield TT 255: Application-optimised combined lightning current and surge arrester for TT and TN-S systems ("3+1" circuit)  
 DEHNshield TN 255: Application-optimised combined lightning current and surge arrester for single-phase TN systems  
 DEHNshield TT 2P 255: Application-optimised combined lightning current and surge arrester for single-phase TT and TN systems ("1+1" circuit)  
 DEHNshield ... FM: With remote signalling contact for monitoring device (floating changeover contact)

The space-saving and application-optimised DEHNshield family offers various benefits provided by type 1 and type 2 spark-gap-based arresters such as the "wave breaker function" (WBF). This function and the associated reduction of the pulse time mitigate the energy of the lightning impulse current to an acceptable level for downstream protection stages or terminal equipment. Moreover, DEHNshield arresters are directly energy coordinated with other arresters of the Red/Line product family. Application-optimised DEHNshield combined lightning current and surge arresters combine lightning equipotential bonding up to lightning impulse currents of 50 kA (10/350  $\mu$ s) and surge protection in a single device. This clearly distinguishes DEHNshield from varistor-based arresters of this application and performance class.

Due to their technical parameters and the very compact design as spark-gap-based arrester with only one module / pole, DEHNshield arresters are ideally suited for this application class. For this reason, they are a space-saving and application-optimised solution in particular for residential buildings.

DEHNshield arresters also provide optimal protection in buildings without external lightning protection system where roof superstructures or overhead line supplies are installed which require type 1 SPDs according to VdS 2031.

No additional backup fuse is needed if an installation is protected by backup fuses up to 160 A.

The energy-coordinated arresters even allow to protect terminal equipment if the distance between DEHNshield and the loads is  $\leq 5 \text{ m}$ . The spark gap without venting means and the small space requirements of the application-optimised combined lightning current and surge arresters enable easy integration into distribution boards.

The follow-current-limiting spark gap technology ensures selectivity with regard to low-current-rated fuses (35 A gG). This means that upstream fuses will not trip due to mains follow currents.

Busbars and pin-shaped terminals from DEHN + SÖHNE can be used for connecting DEHNshield to other DIN rail mounted devices. The type designation of DEHNshield allows to easily choose the right arrester for the relevant system configuration of the low-voltage consumer's installation. The operating state / fault indicator of every protective path needs no power to operate and instantly shows the operating state of the arrester. Apart from the standard visual indicator with green and red indicator flags, the DEHNshield FM versions feature a three-pole remote signalling terminal. With its floating changeover contact, the remote signal can be used as a break or make contact according to the particular circuit concept.

Due to their parameters and design, the DEHNshield devices can be even installed upstream of meter panels in low-voltage consumer's installations.



Series connection by means of a lightning-current-tested STAK 25 pin-shaped terminal

**DEHNshield TNC**

Application-optimised and prewired combined lightning current and surge arrester for TN-C systems with a nominal voltage of 230 / 400 V ("3-0" circuit).



Type DSH ...	TNC 255
Part No.	941 300
SPD according to EN 61643-11 / IEC 61643-11	type 1 + type 2 / class I + class II
Max. continuous operating voltage (a.c.) (U <sub>c</sub> )	255 V (50 / 60 Hz)
Lightning impulse current (10/350 µs) [L1+L2+L3-PEN] (I <sub>total</sub> )	37.5 kA
Lightning impulse current (10/350 µs) [L-PEN] (I <sub>imp</sub> )	12.5 kA
Voltage protection level (U <sub>p</sub> )	≤ 1.5 kV
Max. mains-side overcurrent protection	160 A gG
Approvals	KEMA, VDE, UL

**DEHNshield TNC FM**

Application-optimised and prewired combined lightning current and surge arrester for TN-C systems with with a nominal voltage of 230 / 400 V ("3-0" circuit); with floating remote signalling contact.



NEW

Type DSH ...	TNC 255 FM
Part No.	941 305 <sup>NEW</sup>
SPD according to EN 61643-11 / IEC 61643-11	type 1 + type 2 / class I + class II
Max. continuous operating voltage (a.c.) (U <sub>c</sub> )	255 V (50 / 60 Hz)
Lightning impulse current (10/350 µs) [L1+L2+L3-PEN] (I <sub>total</sub> )	37.5 kA
Lightning impulse current (10/350 µs) [L-PEN] (I <sub>imp</sub> )	12.5 kA
Voltage protection level (U <sub>p</sub> )	≤ 1.5 kV
Max. mains-side overcurrent protection	160 A gG
Type of remote signalling contact	changeover contact

**DEHNshield TNS**

Application-optimised and prewired combined lightning current and surge arrester for TN-S systems with a nominal voltage of 230 / 400 V ("4-0" circuit).



Type DSH ...	TNS 255
Part No.	941 400
SPD according to EN 61643-11 / IEC 61643-11	type 1 + type 2 / class I + class II
Max. continuous operating voltage (a.c.) (U <sub>c</sub> )	255 (50 / 60 Hz)
Lightning impulse current (10/350 µs) [L1+L2+L3+N-PE] (I <sub>total</sub> )	50 kA
Lightning impulse current (10/350 µs) [L, N-PE] (I <sub>imp</sub> )	12.5 kA
Voltage protection level [L-PE]/[N-PE] (U <sub>p</sub> )	≤ 1.5 / ≤ 1.5 kV
Max. mains-side overcurrent protection	160 A gG
Approvals	KEMA, VDE, UL

**DEHNshield TNS FM**

Application-optimised and prewired combined lightning current and surge arrester for TN-S systems with a nominal voltage of 230 / 400 V ("4-0" circuit); with floating remote signalling contact.



NEW

Type DSH ...	TNS 255 FM
Part No.	941 405 <sup>NEW</sup>
SPD according to EN 61643-11 / IEC 61643-11	type 1 + type 2 / class I + class II
Max. continuous operating voltage (a.c.) (U <sub>c</sub> )	255 (50 / 60 Hz)
Lightning impulse current (10/350 µs) [L1+L2+L3+N-PE] (I <sub>total</sub> )	50 kA
Lightning impulse current (10/350 µs) [L, N-PE] (I <sub>imp</sub> )	12.5 kA
Voltage protection level [L-PE]/[N-PE] (U <sub>p</sub> )	≤ 1.5 / ≤ 1.5 kV
Max. mains-side overcurrent protection	160 A gG
Type of remote signalling contact	changeover contact

**DEHNshield TT**

Application-optimised and prewired combined lightning current and surge arrester for TT and TN-S systems with a nominal voltage of 230 / 400 V ("3+1" circuit).



Type DSH ...	TT 255
Part No.	941 310
SPD according to EN 61643-11 / IEC 61643-11	type 1 + type 2 / class I + class II
Max. continuous operating voltage (a.c.) (U <sub>c</sub> )	255 V (50 / 60 Hz)
Lightning impulse current (10/350 µs) [L1+L2+L3+N-PE] (I <sub>total</sub> )	50 kA
Lightning impulse current (10/350 µs) [L-N]/[N-PE] (I <sub>imp</sub> )	12.5 / 50 kA
Voltage protection level [L-N]/[N-PE] (U <sub>p</sub> )	≤ 1.5 / ≤ 1.5 kV
Max. mains-side overcurrent protection	160 A gG
Approvals	KEMA, VDE, UL

### DEHNshield TT FM

Application-optimised and prewired combined lightning current and surge arrester for TT and TN-S systems with a nominal voltage of 230 / 400 V ("3+1" circuit); with floating signalling contact.

Type DSH ...	TT 255 FM
Part No.	941 315 <sup>NEW</sup>
SPD according to EN 61643-11 / IEC 61643-11	type 1 + type 2 / class I + class II
Max. continuous operating voltage (a.c.) (U <sub>c</sub> )	255 V (50 / 60 Hz)
Lightning impulse current (10/350 µs) [L1+L2+L3+N-PE] (I <sub>total</sub> )	50 kA
Lightning impulse current (10/350 µs) [L-N]/[N-PE] (I <sub>imp</sub> )	12.5 / 50 kA
Voltage protection level [L-N]/[N-PE] (U <sub>p</sub> )	≤ 1.5 / ≤ 1.5 kV
Max. mains-side overcurrent protection	160 A gG



### DEHNshield TN

Application-optimised and prewired combined lightning current and surge arrester for single-phase TN systems with a nominal voltage of 230 V ("2-0" circuit).

Type DSH ...	TN 255
Part No.	941 200
SPD according to EN 61643-11 / IEC 61643-11	type 1 + type 2 / class I + class II
Max. continuous operating voltage (a.c.) (U <sub>c</sub> )	255 V (50 / 60 Hz)
Lightning impulse current (10/350 µs) [L+N-PE] (I <sub>total</sub> )	25 kA
Lightning impulse current (10/350 µs) [L, N-PE] (I <sub>imp</sub> )	12.5 kA
Voltage protection level [L-PE]/[N-PE] (U <sub>p</sub> )	≤ 1.5 / ≤ 1.5 kV
Max. mains-side overcurrent protection	160 A gG
Approvals	KEMA, VDE, UL



### DEHNshield TT 2P

Application-optimised and prewired combined lightning current and surge arrester for single-phase TT and TN systems with a nominal voltage of 230 V ("1+1" circuit).

Type DSH ...	TT 2P 255
Part No.	941 110
SPD according to EN 61643-11 / IEC 61643-11	type 1 + type 2 / class I + class II
Max. continuous operating voltage (a.c.) (U <sub>c</sub> )	255 V (50 / 60 Hz)
Lightning impulse current (10/350 µs) [L+N-PE] (I <sub>total</sub> )	25 kA
Lightning impulse current (10/350 µs) [L-N]/[N-PE] (I <sub>imp</sub> )	12.5 / 25 kA
Voltage protection level [L-N]/[N-PE] (U <sub>p</sub> )	≤ 1.5 / ≤ 1.5 kV
Max. mains-side overcurrent protection	160 A gG
Approvals	KEMA, VDE, UL



DEHNcombo

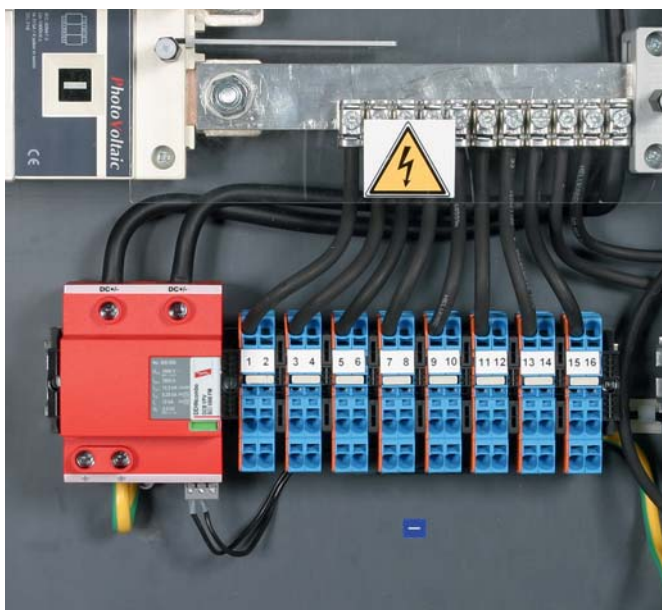

For protecting photovoltaic inverters against surges and even direct lightning strikes. For use in accordance with IEC 60364-7-712 (Installation of photovoltaic power supply systems).

- Prewired type 1 and type 2 combined lightning current and surge arrester for use in photovoltaic generator circuits
- Combined disconnection and short-circuiting device with safe electrical isolation prevents fire damage caused by d.c. switching arcs (patented SCI principle)
- Approved fault-resistant Y circuit prevents damage to the surge protective devices in case of insulation faults in the generator circuit
- Space-saving enclosure with a width of only four modules for up to 1500 V d.c.
- Tested to EN 50539-11
- Suitable for use in all PV systems in accordance with IEC 60364-7-712
- Operating state / fault indication by green / red indicator flag in the inspection window

- DEHNcombo YPV SCI 600: Two-pole combined lightning current and surge arrester for use in photovoltaic power supply systems up to 600 V d.c.
- DEHNcombo YPV SCI 1000: Two-pole combined lightning current and surge arrester for use in photovoltaic power supply systems up to 1000 V d.c.
- DEHNcombo YPV SCI 1500: Two-pole combined lightning current and surge arrester for use in photovoltaic power supply systems up to 1500 V d.c.
- DEHNcombo YPV SCI ... FM: With remote signalling contact for monitoring device (floating changeover contact)

The DEHNcombo YPV SCI ... combined arrester protects equipment in photovoltaic systems against lightning currents.

Thanks to its application-optimised discharge capacity of 6.25 kA (10/350 µs) per pole, DEHNcombo is tailored to meet the requirements of the latest version of the EN 50539-12 standard and Supplement 5 of the German DIN EN 62305-3 standard.

With a short-circuit current rating of 1000 A, DEHNcombo easily meets all requirements placed on surge arresters in small, medium and large photovoltaic systems and can be used without additional backup fuse in all photovoltaic systems up to 1000 A.

Due to its enclosure design which is specifically adapted to the system-specific requirements, even the version for voltages up to 1500 V can be used without taking special precautions (e.g. safety distances). The combined arrester has a width of only four modules, thus allowing space-saving installation.

The patented three-step d.c. switching device (SCI principle) provides an extremely high degree of safety which is required in modern photovoltaic systems. DEHNcombo YPV SCI is available for voltages of 600 V, 1000 V and 1500 V, covering the most common voltage levels of photovoltaic systems.

The fault-resistant Y circuit and the combined disconnection and short-circuiting device further reduce the probability of an arrester failure in case of the operating and fault states which have to be considered in photo-

voltic systems. This ensures reliable operation of the PV system at any time.

A low own consumption of the devices is also an important aspect in PV systems. The operating state / fault indication, which needs no power to operate and instantly provides information on the operating state of the arrester, also fulfils this requirement. With its optional floating changeover contact, the remote signal can be used as a break or make contact according to the particular circuit concept.

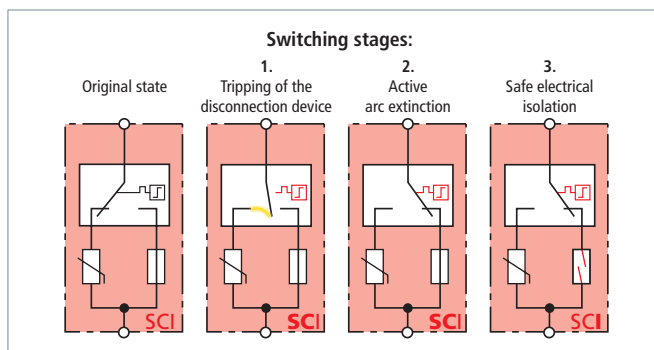

Three-step d.c. switching device (patented SCI principle)

### DEHNcombo YPV SCI ...

Combined lightning current and surge arrester for use in photovoltaic power supply systems up to 1500 V d.c.

Type DCB YPV SCI ...	600	1000	1500
Part No.	900 060	900 061	900 062
SPD according to EN 50539-11	type 1 + type 2	type 1 + type 2	type 1 + type 2
Max. PV voltage [DC+ -> DC-] ( $U_{CPV}$ )	≤ 600 V	≤ 1000 V	≤ 1500 V
Short-circuit current rating ( $I_{SCPV}$ )	1000 A	1000 A	1000 A
Total discharge current (10/350 μs) [DC+/DC- -> PE] ( $I_{total}$ )	12.5 kA	12.5 kA	12.5 kA
Lightning impulse current (10/350 μs) [DC+ -> PE/DC- -> PE] ( $I_{imp}$ )	6.25 kA	6.25 kA	6.25 kA
Voltage protection level [(DC+/DC-) -> PE] ( $U_P$ )	1.75 kV	2.5 kV	3.75 kV
Approvals	KEMA, UL	KEMA, UL	KEMA



### DEHNcombo YPV SCI ... FM

Combined lightning current and surge arrester for use in photovoltaic power supply systems up to 1500 V d.c.; with floating remote signalling contact.

Type DCB YPV SCI ...	600 FM	1000 FM	1500 FM
Part No.	900 065	900 066	900 067
SPD according to EN 50539-11	type 1 + type 2	type 1 + type 2	type 1 + type 2
Max. PV voltage [DC+ -> DC-] ( $U_{CPV}$ )	≤ 600 V	≤ 1000 V	≤ 1500 V
Short-circuit current rating ( $I_{SCPV}$ )	1000 A	1000 A	1000 A
Total discharge current (10/350 μs) [DC+/DC- -> PE] ( $I_{total}$ )	12.5 kA	12.5 kA	12.5 kA
Lightning impulse current (10/350 μs) [DC+ -> PE/DC- -> PE] ( $I_{imp}$ )	6.25 kA	6.25 kA	6.25 kA
Voltage protection level [(DC+/DC-) -> PE] ( $U_P$ )	1.75 kV	2.5 kV	3.75 kV
Approvals	KEMA, UL	KEMA, UL	KEMA
Type of remote signalling contact	changeover contact	changeover contact	changeover contact





DEHN protects.





## DEHNSolid

- Coordinated spark-gap-based lightning current arrester
- Extremely high lightning current discharge capacity up to 200 kA (10/350  $\mu$ s)
- Low voltage protection level  $U_p \leq 2.5$  kV
- Extremely robust design for installation on busbars or mounting plates



For protecting low-voltage consumer's installations against surges and even direct lightning strikes. For installation in conformity with the lightning protection zone concept at the boundaries from  $0_A - 1$ .

### DSO 1 255: Coordinated single-pole lightning current arrester with an extremely high lightning current discharge capacity

The spark gap of the coordinated DEHNSolid lightning current arrester has an extremely high lightning current discharge capacity of 200 kA (10/350  $\mu$ s), making DEHNSolid the most powerful lightning current arrester currently available on the market. Consequently, a technical solution is now available for applications where such powerful surge protective devices are required. The device ensures lightning protection if the lightning current is not distributed and thus the full lightning current may flow through the surge protective device. If a lightning protection level higher than LPL I according to EN 62305 is to be expected, DEHNSolid offers adequate protection.

DEHNSolid features a robust design due to its extreme installation conditions and can be installed in two different ways. On the one hand, the arrester can be directly mounted on the busbar. This ensures a mechanically stable installation, which is required in case of such extreme lightning currents due to the high forces, and short low-impedance connections. On the other hand, the arrester can be screwed onto a mounting plate / fixing unit using the fixing lugs if it is not possible to install it on a busbar. Extremely short and robust connecting cables are required for this device to ensure mechanical strength of the entire arrangement and a minimum voltage drop on the connecting cables to achieve an optimal voltage protection level for the installation.

#### DEHNSolid 1 255

Coordinated single-pole lightning current arrester for use in 230 / 400 V systems; for installation on busbars or mounting plates.

Type	DSO 1 255
Part No.	900 230
Classification according to EN 61643-11 / IEC 61643-11	type 1 / class I
Max. continuous operating voltage (a.c.) ( $U_c$ )	255 V (50 / 60 Hz)
Lightning impulse current (10/350 $\mu$ s) ( $I_{imp}$ )	200 kA
Voltage protection level ( $U_p$ )	$\leq 2.5$ kV
Max. mains-side overcurrent protection	160 A gG



## DEHNbloc® modular



For protecting low-voltage consumer's installations against surges and even direct lightning strikes. For installation in conformity with the lightning protection zone concept at the boundaries from 0<sub>A</sub>–1.

- Coordinated spark-gap-based lightning current arrester consisting of a base part and a plug-in protection module
- Maximum system availability due to RADAX Flow follow current limitation
- No tripping of 32 A gG fuses up to short-circuit currents of 50 kA<sub>rms</sub>
- Discharge capacity up to 50 kA (10/350 μs)
- Directly coordinated with DEHNguard surge protective devices without additional cable length
- Low voltage protection level
- Operating state / fault indication by green / red indicator flag in the inspection window
- Easy replacement of protection modules without tools due to module locking system with module release button

DEHNbloc M 1 ...: Coordinated and modular single-pole lightning current arrester with high follow current limitation  
 DEHNbloc M 1 ... FM: With remote signalling contact for monitoring device (floating changeover contact)

The modular devices of the DEHNbloc M product family are coordinated lightning current arresters with a functional design.

Energy coordination with type 2 surge arresters of the DEHNguard family is ensured without additional cable lengths or decoupling coils. This is one of the most important features of the Red/Line product families.

The DEHNbloc M arresters combine high performance and ease of use in a single device. Their electrical parameters are rated for the most stringent requirements within lightning and surge protection systems. DEHNbloc M is ideally suited for use in the main distribution board of the low-voltage consumer's installation of a building. Equipped with the latest RADAX Flow spark gap technology, the protection and availability of electrical installations is a top priority of DEHNbloc M.

Due to the unique follow current limitation and extinction, fuses are not tripped by follow currents even in case of low-current-rated fuses in the installation. The leakage-current-free protective circuit and the mechanical operating state indicator allow the device to be installed even upstream of meter panels in low-voltage consumer's installations.

The modular DEHNbloc M arresters are safe and easy to use. Their vibration-proof module locking system, for example, is unique. Shock or vibration during transport or operation or enormous mechanical impulse loads resulting from discharges do not affect the module locking system which ensures safe fixation both for the base part and protection module.

Nevertheless, the protection modules can be easily replaced without tools by simply pressing the easy-to-use module release button. Both the base part and protection module are mechanically coded to ensure against installing an incorrect module. DEHNbloc M devices incorporate double terminals, allowing series connection of the arresters in a space-saving and cost-effective way according to IEC 60364-5-53 requirements for nominal currents up to 125 A.



The operating state / fault indicator of DEHNbloc M needs no power to operate and instantly shows the operating state of the device. Apart from the standard visual indicator with red and green indicator flags, DEHNbloc M ... FM devices feature an additional remote signalling output. With its floating changeover contact, the remote signal can be used as a break or make contact according to the particular circuit concept.

### DEHNbloc M 1 ...

Coordinated and modular single-pole lightning current arrester with a high discharge capacity.

Type DB M 1 ...	150	255	320
Part No.	961 110	961 120	961 130
SPD according to EN 61643-11 / IEC 61643-11	type 1 / class I	type 1 / class I	type 1 / class I
Max. continuous operating voltage (a.c.) ( $U_c$ )	150 V (50 / 60 Hz)	255 V (50 / 60 Hz)	320 V (50 / 60 Hz)
Lightning impulse current (10/350 $\mu$ s) ( $I_{imp}$ )	35 kA	50 kA	25 kA
Voltage protection level ( $U_p$ )	$\leq 1.5$ kV	$\leq 2.5$ kV	$\leq 2.5$ kV
Max. backup fuse (L) up to $I_K = 50$ kA <sub>rms</sub> ( $t_a \leq 0.2$ s)	—	500 A gG	315 A gG
Max. backup fuse (L) up to $I_K = 50$ kA <sub>rms</sub> ( $t_a \leq 5$ s)	—	315 A gG	315 A gG
Max. backup fuse (L) up to $I_K = 35$ kA <sub>rms</sub> ( $t_a \leq 0.2$ s)	500 A gG	—	—
Max. backup fuse (L) up to $I_K = 35$ kA <sub>rms</sub> ( $t_a \leq 5$ s)	315 A gG	—	—
Approvals	UL, CSA	VDE, KEMA, UL	UL, CSA



### DEHNbloc M 1 ... FM

Coordinated and modular single-pole lightning current arrester with a high discharge capacity; with remote signalling contact for monitoring system (floating changeover contact).

Type DB M 1 ...	150 FM	255 FM	320 FM
Part No.	961 115	961 125	961 135
SPD according to EN 61643-11 / IEC 61643-11	type 1 / class I	type 1 / class I	type 1 / class I
Max. continuous operating voltage (a.c.) ( $U_c$ )	150 V (50 / 60 Hz)	255 V (50 / 60 Hz)	320 V (50 / 60 Hz)
Lightning impulse current (10/350 $\mu$ s) ( $I_{imp}$ )	35 kA	50 kA	25 kA
Voltage protection level ( $U_p$ )	$\leq 1.5$ kV	$\leq 2.5$ kV	$\leq 2.5$ kV
Max. backup fuse (L) up to $I_K = 50$ kA <sub>rms</sub> ( $t_a \leq 0.2$ s)	—	500 A gG	315 A gG
Max. backup fuse (L) up to $I_K = 50$ kA <sub>rms</sub> ( $t_a \leq 5$ s)	—	315 A gG	315 A gG
Max. backup fuse (L) up to $I_K = 35$ kA <sub>rms</sub> ( $t_a \leq 0.2$ s)	500 A gG	—	—
Max. backup fuse (L) up to $I_K = 35$ kA <sub>rms</sub> ( $t_a \leq 5$ s)	315 A gG	—	—
Approvals	UL, CSA	VDE, KEMA, UL	UL, CSA



## Protection Module for DEHNbloc® modular

- High discharge capacity due to powerful creepage discharge spark gap
- Maximum system availability due to RADAX Flow follow current limitation
- Easy replacement of protection modules without tools due to module locking system with module release button
- Operating state / fault indication by green / red indicator flag in the inspection window
- The plug-in protection module can be replaced without the need to de-energise and removing the vertical cover

The spark-gap-based protection modules for devices of the DEHNbloc M family incorporate the complete protective circuit including the RADAX Flow spark gap and the monitoring circuit for controlling the energy flow. The spark gap monitoring system and the operating state / fault indicator are also housed in the protection module.

Every protection module is mechanically coded to ensure against installing an incorrect replacement module.

As with all modular protective devices, protection modules can be easily replaced without tools by simply pressing the module release button.

### DB M Spark-Gap-Based Protection Module

Spark-gap-based protection module for DEHNbloc M ...

Type DB M MOD ...	150	255	320
Part No.	961 001	961 002	961 003
Max. continuous operating voltage (a.c.) ( $U_c$ )	150 V	255 V	320 V
Lightning impulse current (10/350 $\mu$ s) ( $I_{imp}$ )	35 kA	50 kA	25 kA



For protecting low-voltage consumer's installations against surges and even direct lightning strikes. For installation in conformity with the lightning protection zone concept at the boundaries from 0<sub>A</sub> – 1.

DB M MOD ...: Spark-gap-based protection module

**DEHNbloc® Maxi**



- Encapsulated RADAX Flow spark gap with high follow current limitation
- No tripping of 32 A gG fuses up to short-circuit currents of 50 kA<sub>rms</sub>
- High lightning current discharge capacity
- Directly coordinated with DEHNguard ... and V(A) NH ... surge protective devices without additional cable length
- NH00 versions
- Low voltage protection level

For protecting low voltage consumer's installations against surges and even direct lightning strikes. For installation in conformity with the lightning protection zone concept at the boundaries from 0<sub>A</sub> – 1.

**DBM NH00 255: Coordinated single-pole lightning current arrester in NH00 design with high follow current limitation for U<sub>c</sub> = 255 V**

The coordinated DEHNbloc Maxi ... lightning current arresters adapt themselves to every kind of application. Whether being used in an exposed position or harsh industrial environments: DEHNbloc Maxi ... always offer the right solution. The single-pole devices are coordinated with the approved DEHNguard and V(A) NH surge arresters of the Red/Line family. Irrespective of cable lengths and without requiring additional decoupling coils, the surge protection concept can be adapted individually to all conditions at the installation.

DEHNbloc Maxi arresters provide the patented encapsulated creepage discharge spark gap and RADAX Flow follow current limitation. Special safety distances from busbars or equipment belong to the past as well as tripped backup fuses due to lacking selectivity between the protective device and any overcurrent protection system. This ensures maximum system availability.

DEHNbloc Maxi NH00 255 was specifically designed for industrial distribution boards and supply systems and allows compact and space-saving installation in NH00 fuse holders or NH disconnectors depending on the particular system.



**DEHNbloc Maxi NH00 255**

Coordinated single-pole lightning current arrester in NH00 design for TN-C and TN-S systems with a nominal voltage of 230 / 400 V.



Type	DBM NH00 255
Part No.	900 255
SPD according to EN 61643-11 / IEC 61643-11	type 1 / class I
Max. continuous operating voltage (a.c.) (U <sub>c</sub> )	255 V (50 / 60 Hz)
Lightning impulse current (10/350 μs) (I <sub>imp</sub> )	25 kA
Voltage protection level (U <sub>p</sub> )	≤ 2.5 kV
Max. backup fuse (L) up to I <sub>k</sub> = 50 kA <sub>rms</sub>	315 A gG

**DEHNbloc® Maxi 1 CI 440 / 760 FM**

Spark-gap-based lightning current arrester with integrated lightning current carrying backup fuse in a compact enclosure

- Encapsulated spark gap without venting means
- Extremely high lightning current discharge capacity of 32 kA (10/350  $\mu$ s)
- Low voltage protection level (including backup fuse)
- High follow current extinguishing capability and limitation thanks to RADAX Flow technology
- Energy coordination with other arresters of the Red/Line product family
- Operating state / fault indication by green / red indicator flag in the inspection window



For protecting low-voltage consumer's installations against surges and even direct lightning strikes. For installation in conformity with the lightning protection zone concept at the boundaries from  $0_A - 1$ .

**DEHNbloc Maxi 1 CI 440 FM:** Coordinated single-pole lightning current arrester with integrated backup fuse, high follow current extinguishing capability and remote signalling contact for monitoring device (floating changeover contact) for  $U_c = 440$  V

**DEHNbloc Maxi 1 CI 760 FM:** Coordinated single-pole lightning current arrester with integrated backup fuse, high follow current extinguishing capability and remote signalling contact for monitoring device (floating changeover contact) for  $U_c = 760$  V

The coordinated DEHNbloc Maxi CI 440 and 760 lightning current arresters are specifically designed for higher system voltages, thus efficiently protecting installations from the effects of direct lightning strikes and surges. The features of the proven DEHNbloc Maxi device series and a lightning current carrying arrester backup fuse are combined in the compact enclosure with a width of three standard modules and therefore the devices require up to 60 % less space than a conventional solution.

With system applications getting more and more compact, it is difficult to install lightning current arresters in conformity with the standard. DEHNbloc Maxi CI allows space-saving integration of a type 1 arrester and is said to meet the protection requirements of modern switchgear installations.

Typical fields of application of this arrester are industrial plants with common nominal voltages of 400 / 690 V, IT systems of the chemical industry with nominal voltages of 500 V a.c., protection of the transformer on the low-voltage side of wind turbines and protection of the a.c. side of central inverters of photovoltaic systems.

The integrated backup fuse is dimensioned to ensure maximum discharge capacity and optimal system protection. Consequently, the need to select and install an adequate arrester backup fuse is eliminated, ensuring short connecting cable lengths as required in the IEC 60364-5-53 standard.

The proven spark gaps with wave breaker function and RADAX Flow technology are the core of the coordinated DEHNbloc Maxi CI 440 and 760 lightning current arresters. In case of spark-gap-based type 1 arresters, the full current flows through the type 1 arrester during the discharge process; similar to a wave breaker, the destructive energy is mitigated to a sufficiently low level, thus considerably relieving the downstream SPDs and the entire electrical installation. In addition to this wave breaker function, the RADAX Flow technology reduces and extinguishes mains follow cur-

rents to such a low level that even a 32 A gG fuse does not trip. This ensures high availability and longevity of the electrical installation.

The new enclosure concept allows flexible installation. Due to the typical installation environment, DEHNbloc Maxi CI is delivered with two mounting brackets so that the arresters can also be directly fixed on a mounting plate. However, the arresters can also be mounted on a DIN rail.

The operating state / fault indication of DEHNbloc Maxi CI, which also includes the fuse monitoring, needs no power to operate and instantly shows the status of the devices. Apart from the standard visual indicator with green and red flags, the devices feature a three-pole remote signalling terminal. With its floating changeover contact, the remote signal can be used as a break or make contact according to the particular circuit concept.



Flexible installation using mounting brackets

**NEW**



### DEHNbloc Maxi 1 CI 440 FM

Coordinated single-pole lightning current arrester with integrated backup fuse for 400 / 690 V TN systems and 400 V IT systems; with remote signalling contact for monitoring device (floating changeover contact).

Type DBM 1 CI ...	<b>440 FM</b>
Part No.	<b>961 146</b> <small>NEW</small>
SPD according to EN 61643-11 / IEC 61643-11	type 1 / class I
Maximum continuous operating voltage (a.c.) ( $U_c$ )	440 V (50 / 60 Hz)
Lightning impulse current (10/350 $\mu$ s) ( $I_{imp}$ )	35 kA
Voltage protection level ( $U_p$ )	$\leq 2.5$ kV
Max. mains-side overcurrent protection	not required
Type of remote signalling contact	changeover contact

**NEW**



### DEHNbloc Maxi 1 CI 760 FM

Coordinated single-pole lightning current arrester with integrated backup fuse for 690 V TN / IT systems; with remote signalling contact for monitoring device (floating changeover contact).

Type DBM 1 CI ...	<b>760 FM</b>
Part No.	<b>961 176</b> <small>NEW</small>
SPD according to EN 61643-11 / IEC 61643-11	type 1 / class I
Maximum continuous operating voltage (a.c.) ( $U_c$ )	760 V (50 / 60 Hz)
Lightning impulse current (10/350 $\mu$ s) ( $I_{imp}$ )	35 kA
Voltage protection level ( $U_p$ )	$\leq 4$ kV
Max. mains-side overcurrent protection	not required
Type of remote signalling contact	changeover contact

## Accessories for DEHNbloc® Maxi 1 CI 440 / 760 FM

**NEW**



### Earthing Clip for three-module Enclosures, single-phase, three-pole

Earthing clip for connecting the earth terminal of e.g. three SPDs with three-module enclosure and terminal to earth.

Type	<b>EB 1 3 10</b>
Part No.	<b>900 461</b> <small>NEW</small>
Dimensions	34 x 158 x 28 mm
Clamp	up to 25 mm <sup>2</sup>

**NEW**



### Earthing Clip for three-module Enclosures, single-phase, four-pole

Earthing clip for connecting the earth terminal of e.g. four SPDs with three-module enclosure and terminal to earth.

Type	<b>EB 1 4 13</b>
Part No.	<b>900 462</b> <small>NEW</small>
Dimensions	34 x 212 x 28 mm
Clamp	up to 25 mm <sup>2</sup>

**DEHNbloc® Maxi 440 / 760**

- Spark-gap-based lightning current arrester
- Encapsulated spark gap without venting means
- High follow current extinguishing capability and limitation due RADAX Flow technology
- Directly coordinated with DEHNguard surge protective devices without additional cable length
- Operating state / fault indication by green / red indicator flag in the inspection window



For protecting low-voltage consumer's installations against surges and even direct lightning strikes. For installation in conformity with the lightning protection zone concept at the boundaries from  $0_A - 1$ .

- DEHNbloc Maxi 1 440:** Coordinated single-pole lightning current arrester with high follow current limitation for  $U_c = 440 \text{ V}$   
**DEHNbloc Maxi 1 440 FM:** With remote signalling contact for monitoring device (floating changeover contact)  
**DEHNbloc Maxi 1 760 FM:** Coordinated single-pole lightning current arrester with high follow current limitation for  $U_c = 760 \text{ V}$   
 With remote signalling contact for monitoring device (floating changeover contact)

The coordinated DEHNbloc Maxi 440 and 760 lightning current arresters are specifically designed for high system voltages.

This allows to efficiently protect a variety of industrial applications from direct and indirect lightning currents.

Be it in a wind turbine or a stand-alone low-voltage installation of an industrial enterprise, DEHNbloc Maxi devices exactly fulfil the specific requirements.

Both the design of the protective circuit and the enclosure specifically designed for this type of arrester are particularly adapted to high system voltages.

The approved RADAX Flow technology is the essential core element of the coordinated DEHNbloc Maxi 440 and 760 lightning current arresters. Their capability of considerably limiting mains follow currents and extinguishing them within a few milliseconds makes these devices special.

The patented RADAX Flow follow current limitation ensures that low-value fuses are not tripped by follow currents.

The capability to discharge lightning currents without destruction and to suppress mains follow currents without tripping upstream overcurrent protective devices ensures a high degree of availability in electrical installations.

The operating state / fault indicator of the coordinated lightning current arresters needs no power to operate and immediately shows the operating state of the devices. Apart from the standard visual indication with green and red indicator flags, DEHNbloc Maxi 1 ... FM features a three-pole remote signalling terminal. With its floating changeover contact, the remote signal can be used as a break or make contact according to the particular circuit concept.



## DEHNbloc Maxi 1 440 (FM)

Coordinated single-pole lightning current arrester for use in 400 / 690 V systems; FM version with floating remote signalling contact.



Type DBM 1 ...	440	440 FM
Part No.	961 140	961 145
SPD according to EN 61643-11 / IEC 61643-11	type 1 / class I	type 1 / class I
Max. continuous operating voltage (a.c.) (U <sub>c</sub> )	440 V	440 V
Lightning impulse current (10/350 μs) (I <sub>imp</sub> )	35 kA	35 kA
Voltage protection level (U <sub>p</sub> )	≤ 2.5 kV	≤ 2.5 kV
Max. backup fuse (L) up to I <sub>k</sub> = 50 kA <sub>rms</sub> (t <sub>a</sub> ≤ 0.2 s)	500 A gG	500 A gG
Max. backup fuse (L) up to I <sub>k</sub> = 50 kA <sub>rms</sub> (t <sub>a</sub> ≤ 5 s)	250 A gG	250 A gG
Approvals	UL, CSA	UL, CSA
Type of remote signalling contact	—	changeover contact

## DEHNbloc Maxi 1 760 FM

Coordinated single-pole lightning current arrester for use in 400 / 690 V systems; with remote signalling contact for monitoring device (floating changeover contact).



Type DBM 1 ...	760 FM
Part No.	961 175
SPD according to EN 61643-11 / IEC 61643-11	type 1 / class I
Max. continuous operating voltage (a.c.) (U <sub>c</sub> )	760 V
Lightning impulse current (10/350 μs) (I <sub>imp</sub> )	25 kA
Voltage protection level (U <sub>p</sub> )	≤ 4 kV
Max. backup fuse (L) up to I <sub>k</sub> = 25 kA <sub>rms</sub> (t <sub>a</sub> ≤ 5 s)	250 A gG
Approvals	UL, CSA
Type of remote signalling contact	changeover contact

## Accessories for DEHNbloc® Maxi 440 / 760

### Earthing Clip for two-module Enclosures, single-phase, three-pole

Earthing clip for connecting the earth terminal of e.g. three SPDs with two-module enclosure and terminal to earth.



Type	EB DG 1000 1 3
Part No.	900 411
Dimensions	34 x 112 x 28 mm
Clamp	up to 25 mm <sup>2</sup>

### Earthing Clip for two-module Enclosures, single-phase, four-pole

Earthing clip for connecting the earth terminal of e.g. four SPDs with two-module enclosure and terminal to earth.



Type	EB 1 4 9
Part No.	900 417
Dimensions	34 x 148 x 28 mm
Clamp	up to 25 mm <sup>2</sup>



DEHNbloc® Maxi S

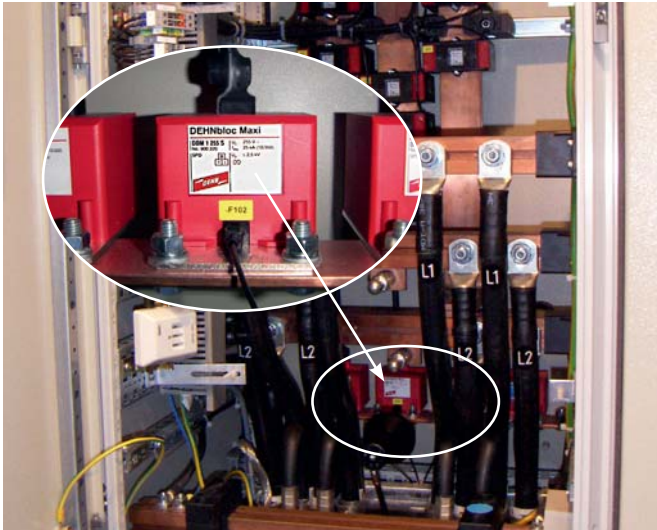

For protecting low voltage consumer's installations against surges and even direct lightning strikes. For installation in conformity with the lightning protection zone concept at the boundaries from  $0_A - 1$ .

DEHNbloc Maxi S can be easily integrated into the application environment of a low-voltage switchgear installation or distribution board.

Thanks to its unique mechanical design, the coordinated DEHNbloc Maxi S lightning current arrester can be directly mounted on the PEN / N busbar of a switchgear installation without the need for additional adapters. With the backup fuse integrated in the device, no other separate backup fuses need to be installed.

Installing DEHNbloc Maxi S directly into the connection panel of a switchgear installation upstream of the circuit breaker ensures short cable lengths of the arresters and a low voltage protection level for the installation. In this environment, the VDE-tested DEHNbloc Maxi S can be used for short-circuit currents up to 100 kA<sub>rms</sub>.

With a discharge capacity of 25 kA (10/350 μs), DEHNbloc Maxi S fulfils the highest national and international lightning protection standards for all three-phase current applications in TN and TT systems.

- Spark-gap-based lightning current arrester with integrated lightning current carrying backup fuse in a compact enclosure
- Directly mounted on the PEN / N busbar
- Low voltage protection level  $U_p \leq 2.5$  kV (including 80 cm connecting cable)
- Directly coordinated with DEHNguard surge protective device without additional cable length
- Short-circuit withstand capability of 100 kA<sub>rms</sub> (220 kA<sub>peak</sub>)
- High follow current extinguishing capability and limitation due to RADAX Flow technology
- High lightning current discharge capacity
- With optical-fibre interface for SPD monitoring

DEHNbloc Maxi 1 255 S: Coordinated lightning current arrester with integrated backup fuse for busbar installation

For "3+1" circuit configurations, DEHNgap Maxi S provides a powerful creepage discharge spark gap with a discharge capacity of 100 kA (10/350 μs).

DEHNbloc Maxi S also features patented RADAX Flow follow current limitation, thus ensuring selectivity even in case of low-current-rated fuses. The capability to conduct lightning impulse currents without destruction and to suppress mains follow currents without tripping upstream overcurrent protective devices ensures the availability of the switchgear installation in the event of a lightning strike. This considerably reduces the risk of arc formation in the installation.

In conjunction with the DEHNsignal remote signalling system, the operating state of DEHNbloc Maxi S devices can be monitored at any time.

Easy-to-implement optical transmission to the DEHNsignal E 3 remote signalling receiver module ensures safe electrical isolation between the power circuit and the remote signalling circuit.

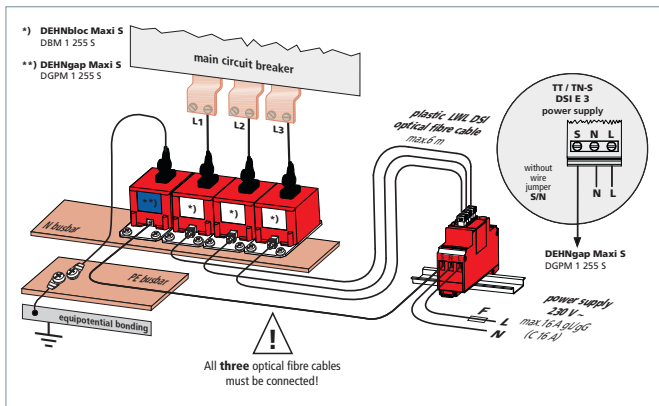

"3+1" application in a TT / TN-S system

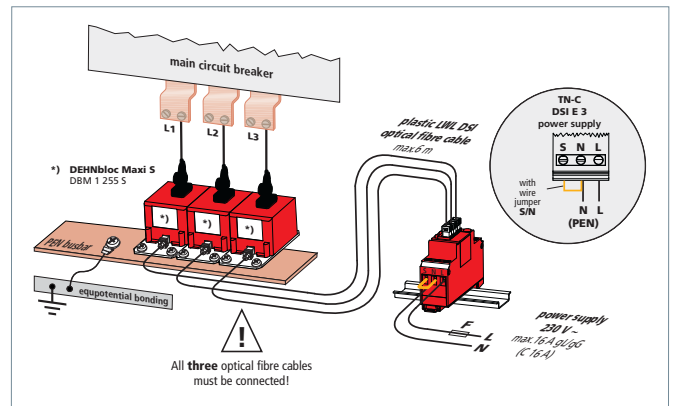

"3-0" application in a TN-C system

DEHNbloc Maxi 1 255 S

Coordinated single-pole lightning current arrester with integrated backup fuse for busbar installation in 230 / 400 V systems.

Type	DBM 1 255 S
Part No.	900 220
SPD according to EN 61643-11 / IEC 61643-11	type 1 / class I
Max. continuous operating voltage (a.c.) ( $U_c$ )	255 V (50 / 60 Hz)
Lightning impulse current (10/350 μs) ( $I_{imp}$ )	25 kA
Voltage protection level ( $U_p$ )	$\leq 2.5$ kV (including 80 cm connecting cable)
Max. mains-side overcurrent protection	not required
Operating state indication	by optical fibre cables via DSI E 3





## DEHNSignal

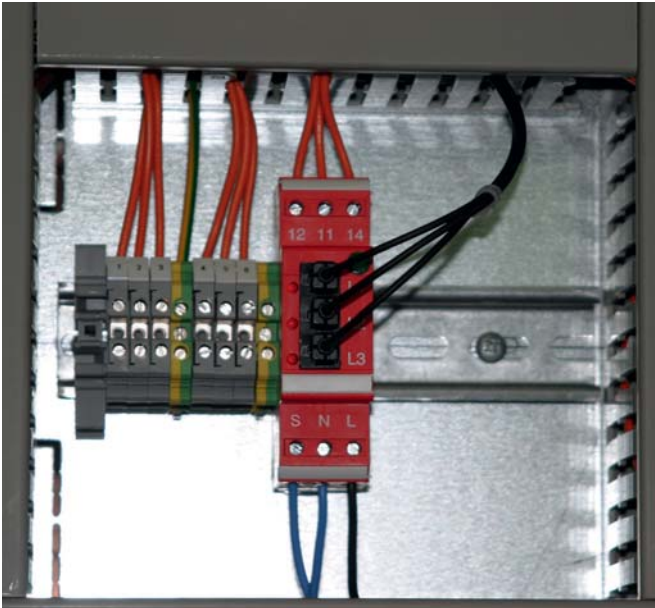

Receiver module for optical transmission with floating changeover contact for DEHNBloc Maxi S and DEHNgap Maxi S surge protective devices.

## Remote signalling and receiver module

- Operating state indication of the surge protective device connected
- Indication of phase failures
- Floating changeover contact
- Selective operating state indication
- Centralised fault indication

**DEHNSignal E 3: Receiver module for optical transmission for selective operating state indication / centralised fault indication of three coordinated DEHNBloc Maxi S and, where appropriate, DEHNgap Maxi S lightning current arresters in five-wire systems**



The DEHNSignal E 3 receiver module for optical transmission transmits remote signals of DEHNBloc Maxi S and DEHNgap Maxi S surge protective devices.

The DEHNSignal E 3 receiver module is particularly adapted to the place of installation of the coordinated DEHNBloc Maxi S and DEHNgap Maxi S surge protective devices.

Three DEHNBloc Maxi S arresters and, if necessary, the N-PE protective circuit can be remotely monitored by the receiver module via optical fibre cables.

Considering the special installation environment of surge protective devices in a switchgear installation, communication via optical fibre cable between the protective devices and the DEHNSignal E 3 receiver module is a considerable safety benefit.



The operating states of the individual arresters are transmitted to the DEHNSignal E 3 receiver module in the form of an optical signal via EMC-resistant plastic optical fibre cables. The optical signals are evaluated in the DEHNSignal E 3 receiver module and are converted into an electrical signal. The operating states can be directly read at the DEHNSignal E 3 receiver module or can be transmitted via a floating changeover contact.

The DEHNSignal E 3 receiver module features a green indicator light to check its operating state. In addition to the operating state indication, the three red indicator lights of the selective operating state indication indicate the operating states of the assigned protective devices.

The receiver module signals if a protective device of a phase fails. The surge protective devices and the DEHNSignal E 3 receiver module can be easily connected via optical fibre cable by means of the accessory parts described.

## Accessory for Arresters – Type 1

### DEHNsignal E 3

Receiver module for optical transmission for selective operating state indication / centralised fault indication of three coordinated DEHNbloc Maxi S and, where appropriate, DEHNgap Maxi S lightning current arresters in five-wire systems.

Type	DSI E 3
Part No.	910 631
Supply voltage (a.c.) ( $U_N$ )	230 V
Power input (P)	< 550 mW
Backup fuse for supply voltage	16 A gG or C 16 A
Signal input	3x via optical fibre plug-in system (LWL ST DSI)
Type of remote signalling contact	floating changeover contact
Test standards	EN 61010-1:1993 and EN 61010-1/A2:1995



## Accessories for DEHNsignal

### LWL ST DSI

Plug for plastic optical fibre cables.

Type	LWL ST DSI
Part No.	910 641
Diameter	2.2 mm



### LWL DSI 18M

18 metres of plastic optical fibre cable, preferably for use with DEHNbloc Maxi S.

Type	LWL DSI 18M
Part No.	910 642
Diameter	2.2 mm
Length	18 m



## DEHNsecure modular



For protecting d.c. consumer's installations against surges and even direct lightning strikes. For installation in conformity with the lightning protection zone concept at the boundaries from  $0_A - 1$ .

- Coordinated spark-gap-based lightning current arrester consisting of a base part and a plug-in protection module
- Spark gap technology particularly suited for use in d.c. circuits
- High lightning current discharge capacity of 25 kA (10/350  $\mu$ s)
- Coordinated with DEHNguard SE DC ... surge protective devices
- Low voltage protection level
- Operating state / fault indication by green / red indicator flag in the inspection window
- Easy replacement of protection modules due to module locking system with module release button

- DEHNsecure M 1 ...: Coordinated and modular single-pole lightning current arrester for d.c. applications  
 DEHNsecure M 1 ... FM: With remote signalling contact for monitoring device (floating changeover contact)  
 DEHNsecure M 2P ...: Coordinated and modular two-pole lightning current arrester for d.c. applications  
 DEHNsecure M 2P ... FM: With remote signalling contact for monitoring device (floating changeover contact)

The modular devices of the DEHNsecure product family are coordinated lightning current arresters with a functional design.

They can be energy-coordinated with type 2 surge arresters of the DEHNguard SE DC family (minimum decoupling length of 1 m must be observed).

The DEHNsecure arresters combine high performance and ease of use in a single device. Their electrical parameters are rated for the most stringent requirements in lightning and surge protection systems.

The internal structure of the DEHNsecure spark gap is suited for use in d.c. circuits. The device concept prevents mains follow currents up to 25.000 A d.c. from occurring.

With this new arrester series, a consistent lightning protection zone concept including the cross-boundary d.c. lines can now be implemented.

Furthermore, the leakage-current-free version of the spark-gap-based arrester offers numerous advantages when used in insulation monitored systems or for applications with extreme requirements on the self-energy consumption.

DEHNsecure arresters are used, for example, in safety lighting systems, emergency power supplies, d.c. systems for direct supply of d.c. drives, control circuits and any kind of battery-operated power supply.

**DEHNsecure M 1 60 (FM)** and **DEHNsecure M 2P 60 (FM)** are specifically developed for Remote Radio Head (RRH) applications. Designed for possible high load currents, they leave sufficient margin for future extensions in the field of mobile communication.

**DEHNsecure M 1 242 (FM)** is used for safety lighting systems. The relevant loads are supplied with a.c. voltage during normal operation and with battery-operated d.c. voltage during emergency operation. As surges may occur during both operating states, DEHNsecure M 1 242 is suited for direct and alternating currents (backup fuse max. 10 A gG).

The modular design of the DEHNsecure arresters makes them safe and user-friendly. Their vibration-proof module locking system, for example, is said to be unique. Shock or vibration during transport or operation or enormous mechanical impulse loads resulting from discharges do not affect the module locking system which ensures safe fixation both for the base part and protection module. Nevertheless, the protection modules can be easily replaced without tools by simply pressing the easy-to-use module release button. The mechanically coded base part and protection module prohibit installing an incorrect module. DEHNsecure arresters incorporate double terminals, allowing series connection of the arresters in a space-saving and cost-effective way according to IEC 60364-5-53 requirements for nominal currents up to 125 A.

The operating state / fault indicator of DEHNsecure needs no power to operate and instantly shows the operating state of the device. Apart from the standard visual indicator with red and green indicator flags, DEHNsecure ... FM devices have an additional remote signalling output. With its floating changeover contact, the remote signal can be used as a break or make contact according to the particular circuit concept.

### DEHNsecure M 1 ...

Coordinated and modular single-pole lightning current arrester for d.c. applications.

Type DSE M ...	1 60	1 220	1 242
Part No.	971 121	971 120	971 122
SPD classification according to EN 61643-11 / IEC 61643-11	type 1 / class I	type 1 / class I	type 1 / class I
Max. continuous operating voltage (d.c.) ( $U_c$ )	60 V	220 V	242 V
Lightning impulse current (10/350 $\mu$ s) ( $I_{imp}$ )	25 kA	25 kA	25 kA
Voltage protection level ( $U_p$ )	$\leq 1.5$ kV	$\leq 2.5$ kV	$\leq 2.5$ kV
Max. mains-side overcurrent protection	250 A gL	250 A gL	250 A gL
Approvals	UL	UL	UL
<b>Extended technical data:</b>	<b>for use in safety lighting systems</b>		
– Max. continuous operating voltage (a.c.) ( $U_c$ )	—	—	255 V



### DEHNsecure M 1 ... FM

Coordinated and modular single-pole lightning current arrester for d.c. applications; with remote signalling contact for monitoring device (floating changeover contact).

Type DSE M ...	1 60 FM	1 220 FM	1 242 FM
Part No.	971 126	971 125	971 127
SPD classification according to EN 61643-11 / IEC 61643-11	type 1 / class I	type 1 / class I	type 1 / class I
Max. continuous operating voltage (d.c.) ( $U_c$ )	60 V	220 V	242 V
Lightning impulse current (10/350 $\mu$ s) ( $I_{imp}$ )	25 kA	25 kA	25 kA
Voltage protection level ( $U_p$ )	$\leq 1.5$ kV	$\leq 2.5$ kV	$\leq 2.5$ kV
Max. mains-side overcurrent protection	250 A gL	250 A gL	250 A gL
Approvals	UL	UL	UL
Type of remote signalling contact	changeover contact	changeover contact	changeover contact
<b>Extended technical data:</b>	<b>for use in safety lighting systems</b>		
– Max. continuous operating voltage (a.c.) ( $U_c$ )	—	—	255 V



### DEHNsecure M 2P ... (FM)

Coordinated and modular two-pole lightning current arrester for d.c. applications up to 60 V („1+1“ circuits); FM version with floating remote signalling contact.

Type DSE M ...	2P 60	2P 60 FM
Part No.	971 221	971 226
SPD classification according to EN 61643-11 / IEC 61643-11	type 1 / class I	type 1 / class I
Max. continuous operating voltage (d.c.) ( $U_c$ )	60 V	60 V
Lightning impulse current (10/350 $\mu$ s) (DC+/DC- -> DC-/DC+) / (DC-/DC+ -> $\frac{\pm}{\pm}$ ) ( $I_{imp}$ )	25 / 50 kA	25 / 50 kA
Voltage protection level (DC+/DC- -> DC-/DC+) / (DC-/DC+ -> $\frac{\pm}{\pm}$ ) ( $U_p$ )	$\leq 1.5 / \leq 1.5$ kV	$\leq 1.5 / \leq 1.5$ kV
Max. mains-side overcurrent protection	250 A gL	250 A gL
Approvals	UL	UL
Type of remote signalling contact	—	changeover contact





Protection Module for DEHNsecure modular



- Spark gap technology particularly suited for use in d.c. circuits
- Operating state / fault indication by green / red indicator flag in the inspection window
- Easy replacement of protection modules without tools due to module locking system with module release button

For protecting d.c. consumer's installations against surges and even direct lightning strikes. For installation in conformity with the lightning protection zone concept at the boundaries from  $O_A - 1$ .

DSE MOD ...: Spark-gap-based protection module

Lightning Current Arresters – Type 1

**DSE M Spark-Gap-Based Protection Module**

Spark-gap-based protection module



Type DSE MOD ...	60	220	242
Part No.	971 001	971 002	971 003
Max. continuous operating voltage (d.c.) ( $U_c$ )	60 V	220 V	242 V
Lightning impulse current (10/350 $\mu$ s) ( $I_{imp}$ )	25 kA	25 kA	25 kA

**DSE PE Spark-Gap-Based Protection Module**

Spark-gap-based protection module



Type DSE MOD ...	PE 60
Part No.	971 010
Max. continuous operating voltage (d.c.) ( $U_c$ )	60 V
Lightning impulse current (10/350 $\mu$ s) ( $I_{imp}$ )	50 kA

**DEHNbloc®**

- Encapsulated creepage discharge spark gap without venting means
- RADAX Flow spark gap technology with high follow current limitation
- Energy coordination with other arresters of the Red/Line product family
- Can also be used upstream of meter panels due to its high insulation resistance
- Multifunctional terminal for connecting conductors and busbars
- Single-pole and three-pole version (lightning impulse currents up to 100 kA depending on the system configuration)
- Modular single-pole version also available

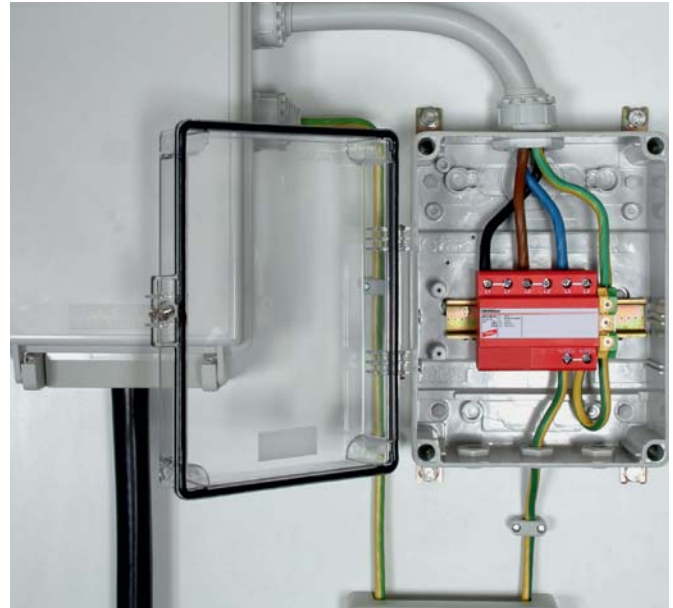

For protecting low-voltage consumer's installations against surges and even direct lightning strikes. For installation in conformity with the lightning protection zone concept at the boundaries from  $0_A - 1$ .

**DEHNbloc H M 1 255: Modular single-pole lightning current arrester with high follow current limitation**

**DEHNbloc 1 255 H: Single-pole lightning current arrester with high follow current limitation**

**DEHNbloc 3 255 H: Three-pole lightning current arrester with high follow current limitation**

The spark gaps of the DEHNbloc lightning current arresters allow compact configuration of low-voltage distribution boards. By using pressurised and encapsulated creepage discharge spark gaps, no safety distance from busbars and special flameproof enclosures are necessary.

With a lightning current discharge capacity up to 50 kA (10/350  $\mu$ s) per pole, DEHNbloc devices fulfil highest national and international lightning protection and application standards.

The consistent improvement of the integration concept made the DEHNbloc devices even more efficient: With DEHNbloc H, the ground-breaking RADAX Flow spark gap technology for follow current extinction and limitation was integrated into the DEHNbloc family.

The RADAX Flow technology prevents that system operation is disrupted due to a tripped circuit breaker as soon as the arrester operates. In times where systems increasingly depend on a properly functioning electrical infrastructure, this is an indispensable product feature. Thanks to the patented RADAX Flow principle, even the amplitude of short-circuit currents in installations up to 50 kA<sub>rms</sub> can be limited to approx. 500 A and extinguished after approximately 5 ms. This feature ensures selectivity even in case of low-current-rated fuses.

But the DEHNbloc H family concept also stands out due to other product features: With its double terminals on the phase and earth side, the single-pole DEHNbloc 1 255 H device offers various application options.

The DBH M 1 255 device with a new arrester design features the approved module release system that safely fixes the protection module to the base part even at maximum loads on the protection module. The modules can be easily replaced without tools by simply pressing the module release button of the protection module.

By using the double terminals suitable for all conductors, even three-pole DEHNbloc 3 255 H arresters can be connected in series in a space-saving and cost-effective way up to nominal currents of 125 A as preferred by IEC 60364-5-53.

If DEHNbloc is to be used with other DIN rail mounted devices, the multifunctional terminals are ideally suited for providing connection for conductors and busbars.

## DEHNbloc H

Modular single-pole lightning current arrester with a high discharge capacity for use in 230 / 400 V systems.



Type	DBH M 1 255
Part No.	961 122
SPD according to EN 61643-11 / IEC 61643-11	type 1 / class I
Max. continuous operating voltage (a.c.) ( $U_c$ )	255 V (50 / 60 Hz)
Lightning impulse current (10/350 $\mu$ s) ( $I_{imp}$ )	50 kA
Voltage protection level ( $U_p$ )	$\leq 4$ kV
Max. backup fuse (L) up to $I_k = 50$ kA <sub>rms</sub> ( $t_a \leq 0.2$ s)	500 A gG
Max. backup fuse (L) up to $I_k = 50$ kA <sub>rms</sub> ( $t_a \leq 5$ s)	315 A gG

## Accessories for DEHNbloc®

### DB H Spark-Gap-Based Protection Module

Spark-gap-based protection module



Type	DBH MOD 255
Part No.	961 022
Max. continuous operating voltage (a.c.) ( $U_c$ )	255 V

### DEHNbloc 1 255 H

Single-pole ("3-0" circuit) lightning current arrester with a high discharge capacity for use in 230 / 400 V systems.



Type	DB 1 255 H
Part No.	900 222
SPD according to EN 61643-11 / IEC 61643-11	type 1 / class I
Max. continuous operating voltage (a.c.) ( $U_c$ )	255 V (50 / 60 Hz)
Lightning impulse current (10/350 $\mu$ s) ( $I_{imp}$ )	50 kA
Voltage protection level ( $U_p$ )	$\leq 4$ kV
Max. backup fuse up to $I_k = 50$ kA <sub>rms</sub> ( $t_a \leq 0.2$ s)	500 A gG
Max. backup fuse up to $I_k = 50$ kA <sub>rms</sub> ( $t_a \leq 5$ s)	315 A gG
Approvals	KEMA

### DEHNbloc 3 255 H

Three-pole ("3-0" circuit) lightning current arrester with a high discharge capacity for use in 230 / 400 V systems.



Type	DB 3 255 H
Part No.	900 120
SPD according to EN 61643-11 / IEC 61643-11	type 1 / class I
Max. continuous operating voltage (a.c.) ( $U_c$ )	255 V (50 / 60 Hz)
Lightning impulse current (10/350 $\mu$ s) [L1+L2+L3-N/PEN] ( $I_{total}$ )	100 kA
Voltage protection level ( $U_p$ )	$\leq 4$ kV
Max. backup fuse up to $I_k = 50$ kA <sub>rms</sub> ( $t_a \leq 0.2$ s)	500 A gG
Max. backup fuse up to $I_k = 50$ kA <sub>rms</sub> ( $t_a \leq 5$ s)	315 A gG
Approvals	KEMA



## DEHNgap

- Discharge capacity up to 100 kA (10/350  $\mu$ s)
- Total current arrester specifically designed for installation in "3+1" and "1+1" circuits of TT systems according to IEC 60364-5-53 between neutral conductor N and protective conductor PE
- Creepage discharge spark gap technology
- Operating state / fault indication by green / red indicator flag in the inspection window



For protecting low-voltage consumer's installations against surges and even direct lightning strikes. For installation in conformity with the lightning protection zone concept at the boundaries from  $0_A - 1$  ("3+1" circuit).

DEHNgap M 255 (FM):	Coordinated and modular single-pole N-PE lightning current arrester
DEHNgap Maxi 1 255 S:	Coordinated single-pole N-PE lightning current arrester for busbars
DEHNgap Maxi 1 255 (FM):	Coordinated single-pole N-PE lightning current arrester for "3+1" circuits with DEHNvenCI
DEHNgap Maxi 440 (FM):	Coordinated single-pole N-PE lightning current arrester for $U_c = 440$ V a.c.
DEHNgap H M 255:	Modular single-pole N-PE lightning current arrester

Being total current arresters between the neutral and protective conductor in TT systems, the single-pole N-PE lightning current arresters of type DEHNgap M, DEHNgap Maxi, DEHNgap Maxi S and DEHNgap H M fulfil the requirements for the protection of persons and equipment in "1+1" or "3+1" circuits.

The creepage discharge spark gaps were specifically developed to meet this challenge. With a discharge capacity up to 100 kA (10/350  $\mu$ s), they fulfil the highest national and international lightning protection standards. Their leakage-current-free spark gap design allows the devices to be used in areas upstream of the meter panel according to the German VDN guideline.

The DEHNgap M, DEHNgap Maxi S and DEHNgap Maxi coordinated N-PE lightning current arresters hold a special position among total current arresters. Due to their low voltage protection level, they can be directly coordinated with N-PE surge arresters of the DEHNguard M family and DEHNgap C S surge arresters without additional decoupling coil. If lightning current arresters are to be installed along with surge arresters at the same location, no additional DEHNgap C S is required thanks to the low voltage protection level of DEHNgap M and DEHNgap Maxi.

The design and installation of DEHNgap Maxi S arresters are adapted to the unique nature of low-voltage switchgear installations and entirely complement the use of DEHNbloc Maxi S arresters.

The multifunctional terminals of the DIN rail mounted DEHNgap M and DEHNgap H M devices are suitable for connecting conductors and busbars, allowing comfortable wiring with other DIN rail mounted terminals. With its functional Red/Line design, DEHNgap M combines safety and

ease of use in a single device. The mechanical operating state / fault indication as well as the unique module locking system stand for fulfilling high safety requirements. The module locking system fixes the protection modules to the base part. Neither vibration during transport nor the enormous electromagnetic forces of discharge can loosen the protection modules. Nevertheless, they can be easily replaced without tools by simply pressing the easy-to-use module release button of the protection module. Each protection module is mechanically coded to ensure against installing an incorrect module. Apart from the standard visual indication of DEHNgap M, DEHNgap M ... FM features a three-pole remote signalling terminal. With its floating changeover contact, the remote signal can be used as a break or make contact according to the particular circuit concept.



**DEHNgap M 255 (FM)**

Coordinated and modular single-pole N-PE lightning current arrester; FM version with floating remote signalling contact.



Type	DGP M 255	DGP M 255 FM
Part No.	961 101	961 105
SPD according to EN 61643-11 / IEC 61643-11	type 1 / class I	type 1 / class I
Max. continuous operating voltage (a.c.) (U <sub>c</sub> )	255 V (50 / 60 Hz)	255 V (50 / 60 Hz)
Lightning impulse current (10/350 μs) (I <sub>imp</sub> )	100 kA	100 kA
Voltage protection level (U <sub>p</sub> )	≤ 1.5 kV	≤ 1.5 kV
Approvals	VDE, KEMA, UL	VDE, KEMA, UL
Type of remote signalling contact	—	changeover contact

**DEHNgap Maxi 1 255 S**

Coordinated single-pole N-PE lightning current arrester for busbars.



Type	DGPM 1 255 S
Part No.	900 050
SPD according to EN 61643-11 / IEC 61643-11	type 1 / class I
Max. continuous operating voltage (a.c.) (U <sub>c</sub> )	255 V (50 / 60 Hz)
Lightning impulse current (10/350 μs) (I <sub>imp</sub> )	100 kA
Voltage protection level (U <sub>p</sub> )	≤ 2.5 kV (80 cm connecting cable included)
Operating state monitoring	via DEHNSignal DSI E 3

**DEHNgap Maxi 1 255 (FM)**

Coordinated single-pole N-PE lightning current arrester; FM version with floating remote signalling contact.



Type	DGPM 1 255	DGPM 1 255 FM
Part No.	961 180	961 185
SPD according to EN 61643-11 / IEC 61643-11	type 1 / class I	type 1 / class I
Max. continuous operating voltage (a.c.) (U <sub>c</sub> )	255 V (50 / 60 Hz)	255 V (50 / 60 Hz)
Lightning impulse current (10/350 μs) (I <sub>imp</sub> )	100 kA	100 kA
Voltage protection level (U <sub>p</sub> )	≤ 1.5 kV	≤ 1.5 kV
Type of remote signalling contact	—	changeover contact

**DEHNgap Maxi 440 (FM)**

Coordinated single-pole N-PE lightning current arrester; FM version with floating remote signalling contact.



Type	DGPM 440	DGPM 440 FM
Part No.	961 160	961 165
SPD according to EN 61643-11 / IEC 61643-11	type 1 / class I	type 1 / class I
Max. continuous operating voltage (a.c.) (U <sub>c</sub> )	440 V (50 / 60 Hz)	440 V (50 / 60 Hz)
Lightning impulse current (10/350 μs) (I <sub>imp</sub> )	100 kA	100 kA
Voltage protection level (U <sub>p</sub> )	≤ 2.5 kV	≤ 2.5 kV
Approvals	UL	UL
Type of remote signalling contact	—	changeover contact

**DEHNgap H M 255**

Modular single-pole N-PE lightning current arrester.



Type	DGPH M 255
Part No.	961 102
SPD according to EN 61643-11 / IEC 61643-11	type 1 / class I
Max. continuous operating voltage (a.c.) (U <sub>c</sub> )	255 V (50 / 60 Hz)
Lightning impulse current (10/350 μs) (I <sub>imp</sub> )	100 kA
Voltage protection level (U <sub>p</sub> )	≤ 4 kV

**Protection Module for DEHNgap modular**

- High discharge capacity due to powerful creepage discharge spark gap
- Easy replacement of protection modules without tools due to module locking system with module release button
- Operating state / fault indication by green / red indicator flag in the inspection window
- The plug-in protection module can be replaced without the need to de-energise and without removing the distribution board cover



For protecting low-voltage consumer's installations against surges and even direct lightning strikes. For installation in conformity with the lightning protection zone concept at the boundaries from  $0_A - 1$  (3+1 circuits).

**DGP M MOD 255:** 100 kA N-PE spark-gap-based protection module for all devices of the modular DEHNgap M family

**DGPH MOD 255:** 100 kA N-PE spark-gap-based protection module for all devices of the modular DEHNgap M H family

The N-PE spark-gap-based protection modules of the modular DEHNgap M family combine safety and innovation in a single device. Apart from the powerful encapsulated creepage discharge spark gap, the compact protection modules incorporate a monitoring device and an operating state / fault indicator. The mechanical coding of the protection module prevents

that the N-PE protection modules are confused with the spark-gap-based protection module for the phase conductors. The module locking system safely fixes the protection modules to the base part. The protection modules can be easily removed without tools by simply pressing the release button.

**DGP M – 100 kA N-PE Spark-Gap-Based Protection Module**

N-PE spark-gap-based protection module for all devices of the modular DEHNgap M family.

Type	<b>DGP M MOD 255</b>
Part No.	<b>961 010</b>
Max. continuous operating voltage (a.c.) ( $U_c$ )	255 V
Lightning impulse current (10/350 $\mu$ s) ( $I_{imp}$ )	100 kA



**DGPH M – 100 kA N-PE Spark-Gap-Based Protection Module**

N-PE spark-gap-based protection module for all devices of the modular DEHNgap M H family.

Type	<b>DGPH MOD 255</b>
Part No.	<b>961 020</b>
Max. continuous operating voltage (a.c.) ( $U_c$ )	255 V
Lightning impulse current (10/350 $\mu$ s) ( $I_{imp}$ )	100 kA





Selection Chart – Industrial Building

TN-C system	TN-S system	TT system	230/400 V a.c.	400/690 V a.c.	Higher voltages (a.c.)	Integrated backup fuse	DIN rail	d.c. applications	PV system	Remote signalling contact	Type	Part No.	Page
1 pc			•			•	•				DG M TNC CI 275	952 304	53
1 pc			•			•	•		•		DG M TNC CI 275 FM	952 309	53
	1 pc		•			•	•				DG M TNS CI 275	952 401	53
	1 pc		•			•	•		•		DG M TNS CI 275 FM	952 406	53
		1 pc	•			•	•				DG M TT CI 275	952 322	53
		1 pc	•			•	•		•		DG M TT CI 275 FM	952 327	53
1 pc			•				•				DG M TNC 275	952 300	56
1 pc			•				•		•		DG M TNC 275 FM	952 305	56
	1 pc		•				•				DG M TNS 275	952 400	56
	1 pc		•				•		•		DG M TNS 275 FM	952 405	56
		1 pc	•				•				DG M TT 275	952 310	56
		1 pc	•				•		•		DG M TT 275 FM	952 315	57
3 pcs	4 pcs	3 pcs	•			•	•				DG S CI 275	952 079	54
3 pcs	4 pcs	3 pcs	•				•				DG S 275	952 070	59
		1 pc	•				•				DGP C S	952 030	66
3 pcs	4 pcs	3 pcs	•			•	•		•		DG S CI 275 FM	952 099	54
3 pcs	4 pcs	3 pcs	•				•		•		DG S 275 FM	952 090	60
		1 pc	•				•		•		DGP C S FM	952 035	66
1 pc				•			•				DG M TNC 440	952 303	56
1 pc				•			•		•		DG M TNC 440 FM	952 308	56
3 pcs	4 pcs				•		•				DG S WE 600	952 077	60
3 pcs	4 pcs				•		•		•		DG S WE 600 FM	952 097	60
1 pc					•		•				DG M WE 600	952 302	58
1 pc					•		•		•		DG M WE 600 FM	952 307	58
3 pcs	4 pcs				•		•		•		DG SE H 1000 FM	952 938	64
3 pcs	4 pcs	3 pcs	•				•		•		DG SE H LI 275 FM	952 930	64
		1 pc	•				•		•		DGP C S FM	952 035	66
							•	•			DG SE DC 242	972 120	68
							•	•	•		DG SE DC 242 FM	972 125	68
							•	•	•		DG M YPV SCI 1000	952 510	70
							•	•	•		DG M YPV SCI 1000 FM	952 515	70
								•	•		DCU YPV SCI 1000 1M	900 910	77

Surge Arresters – Type 2

Selection Chart – Office Building

TN-C system	TN-S system	TT system	Integrated backup fuse 	DIN rail	Single phase application	d.c. application	Remote signalling contact 	Type	Part No.	Page
1 pc			●	●				DG M TNC CI 275	952 304	53
1 pc			●	●			●	DG M TNC CI 275 FM	952 309	53
	1 pc		●	●				DG M TNS CI 275	952 401	53
	1 pc		●	●			●	DG M TNS CI 275 FM	952 406	53
		1 pc	●	●				DG M TT CI 275	952 322	53
		1 pc	●	●			●	DG M TT CI 275 FM	952 327	53
3 pcs	4 pcs	3 pcs ↙	●	●				DG S CI 275	952 079	54
		1 pc ↙		●				DGP C S	952 030	66
3 pcs	4 pcs	3 pcs ↙	●	●			●	DG S CI 275 FM	952 099	54
		1 pc ↙		●			●	DGP C S FM	952 035	66
1 pc				●				DG M TNC 275	952 300	56
1 pc				●			●	DG M TNC 275 FM	952 305	56
	1 pc			●				DG M TNS 275	952 400	56
	1 pc			●			●	DG M TNS 275 FM	952 405	56
		1 pc		●				DG M TT 275	952 310	56
		1 pc		●			●	DG M TT 275 FM	952 315	57
3 pcs	4 pcs	3 pcs ↙		●				DG S 275	952 070	59
		1 pc ↙		●				DGP C S	952 030	66
3 pcs	4 pcs	3 pcs ↙		●			●	DG S 275 FM	952 090	60
3 pcs	4 pcs	3 pcs ↙		●			●	DG SE H LI 275 FM	952 930	64
		1 pc ↙		●			●	DGP C S FM	952 035	66
					●			DCOR L 2P 275	900 430	65
					●			DCOR L 1P 275	900 431	65
				●		●		DG SE DC 242	972 120	68
				●		●	●	DG SE DC 242 FM	972 125	68

Selection Chart – Residential Building

TN-C system	TN-S system	TT system	DIN rail	PV system 	Remote signalling contact	Type	Part No.	Page
1 pc			●			DG M TNC 275	952 300	56
1 pc			●		●	DG M TNC 275 FM	952 305	56
	1 pc		●			DG M TNS 275	952 400	56
	1 pc		●		●	DG M TNS 275 FM	952 405	56
		1 pc	●			DG M TT 275	952 310	56
		1 pc	●		●	DG M TT 275 FM	952 315	57
3 pcs	4 pcs	3 pcs ↙	●			DG S 275	952 070	59
		1 pc ↙	●			DGP C S	952 030	66
3 pcs	4 pcs	3 pcs ↙	●		●	DG S 275 FM	952 090	60
		1 pc ↙	●		●	DGP C S FM	952 035	66
				●		DCU YPV SCI 1000 1M	900 910	77
			●	●		DG YPV SCI 1000	950 530	75
			●	●	●	DG YPV SCI 1000 FM	950 535	75

## DEHNguard® modular with integrated Backup Fuse

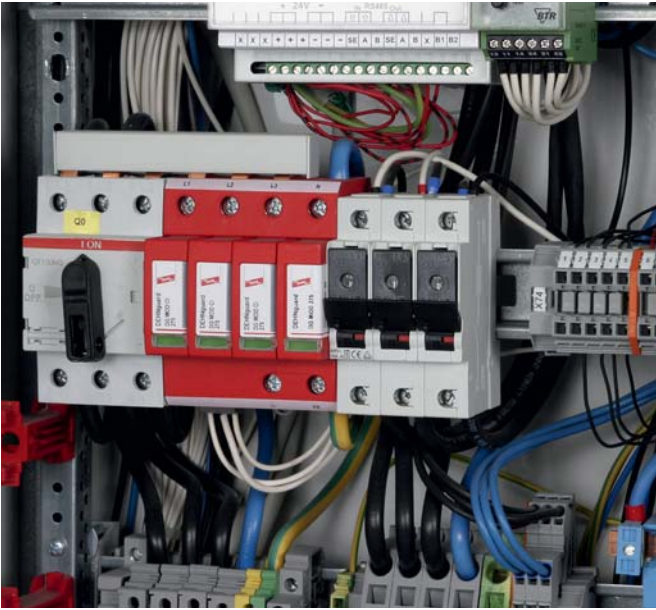

For protecting low-voltage consumer's installations against surges. For installation in conformity with the lightning protection zone concept at the boundaries from  $O_B - 1$  and higher.

- DEHNguard M TNC CI 275:** Modular surge arrester with integrated backup fuse for TN-C systems
- DEHNguard M TNS CI 275:** With integrated backup fuse for TN-S systems
- DEHNguard M TT CI 275:** With integrated backup fuse for TT and TN-S systems ("3+1" circuits)
- DEHNguard M TN CI 275:** With integrated backup fuse for 230 V TN systems
- DEHNguard M TT 2P CI 275:** With integrated backup fuse for 230 V TT and TN systems ("1+1" circuits)
- DEHNguard S CI 275:** Modular single-pole surge arrester with integrated backup fuse
- DEHNguard M ... CI 275 FM:** With remote signalling contact for monitoring device (floating changeover contact)

Featuring the functional Red/Line design, the modular surge arresters of the DEHNguard ... CI family combine short-circuit and surge protection in a single protection module with a width of only one module, setting new patterns for ease of application.

The protective circuit has the arrester backup fuse integrated in the protection module. This feature together with the heavy-duty zinc oxide varistor and the dual "Thermo Dynamic Control" monitoring device allow easy installation with minimum space requirements.

With the already integrated arrester backup fuse, the user no longer has to care about arrester-specific dimensioning requirements such as backup protection in the event of a short-circuit and impulse current carrying capability.

Space-saving surge protection measures covering all functions specified in the installation standards can be implemented in installations with short-circuit currents up to 25 kA<sub>rms</sub>. All paths including the N-PE path feature an operating state indicator as required by the IEC 60364-5-53 standard.

Due to the "Thermo Dynamic Control" monitoring device, the surface temperature of the heavy-duty varistor and the intensity of the discharge current are used for evaluation. The operating state of each protective path is shown by means of a mechanical indicator with green and red indicator flags which needs no power to operate. It also indicates the activation of the "Thermo Dynamic Control" monitoring device and the integrated arrester backup fuse.

- Arrester backup fuse integrated in the protection module
- Prewired complete unit consisting of a base part and plug-in protection modules
- Energy coordination with other arresters of the Red/Line product family
- High discharge capacity
- High reliability due to "Thermo Dynamic Control" SPD monitoring device
- Easy replacement of protection modules without tools due to module locking system with module release button

In addition to this mechanical operating state / fault indication, the ... FM version of the DEHNguard ... CI devices features a three-pole remote signalling terminal. With its floating changeover contact, the remote signal can be used as break or make contact according to the particular circuit concept.

All the benefits of the modular design of the DEHNguard family have been integrated into the new DEHNguard ... CI family.

The system-configuration-specific product designation and the "Thermo Dynamic Control" monitoring device reflect the high safety requirements. The unique module locking system prevents the protection modules from becoming loose due to vibration during transport or the enormous forces of discharge. Nevertheless, the protection modules can be easily replaced without tools, the need to de-energise and removing the distribution board cover by simply pressing the easy-to use module release button of the protection modules. Each protective circuit in the multipole and single-pole arresters and each protection module is mechanically coded to ensure against installing an incorrect protection module.

The surge arresters of the modular DEHNguard ... CI family feature multifunctional terminals on a standardised spacing of one module for connecting conductors and busbars, allowing easy wiring with other DIN rail mounted devices. Thus, a variety of applications can be easily connected in series in accordance with IEC 60364-5-53 for optimal protection.

### DEHGuard M TNC CI ... (FM)

Modular surge arrester with integrated backup fuses for TN-C systems with a nominal voltage of 230 / 400 V ("3-0" circuit); FM version with floating remote signalling contact.

Type DG ...	M TNC CI 275	M TNC CI 275 FM
Part No.	952 304	952 309
SPD according to EN 61643-11 / IEC 61643-11	type 2 / class II	type 2 / class II
Max. continuous operating voltage (a.c.) ( $U_C$ )	275 V (50 / 60 Hz)	275 V (50 / 60 Hz)
Nominal discharge current (8/20 $\mu$ s) ( $I_n$ )	12.5 kA	12.5 kA
Max. discharge current (8/20 $\mu$ s) ( $I_{max}$ )	25 kA	25 kA
Voltage protection level ( $U_P$ )	$\leq 1.5$ kV	$\leq 1.5$ kV
Max. mains-side overcurrent protection	not required	not required
Approvals	KEMA, VDE	KEMA, VDE
Type of remote signalling contact	—	changeover contact



### DEHGuard M TNS CI ... (FM)

Modular surge arrester with integrated backup fuses for TN-S systems with a nominal voltage of 230 / 400 V ("4-0" circuit); FM version with floating remote signalling contact.

Type DG ...	M TNS CI 275	M TNS CI 275 FM
Part No.	952 401	952 406
SPD according to EN 61643-11 / IEC 61643-11	type 2 / class II	type 2 / class II
Max. continuous operating voltage (a.c.) ( $U_C$ )	275 V (50 / 60 Hz)	275 V (50 / 60 Hz)
Nominal discharge current (8/20 $\mu$ s) ( $I_n$ )	12.5 kA	12.5 kA
Max. discharge current (8/20 $\mu$ s) ( $I_{max}$ )	25 kA	25 kA
Voltage protection level [L-PE] / [N-PE] ( $U_P$ )	$\leq 1.5 / \leq 1.5$ kV	$\leq 1.5 / \leq 1.5$ kV
Max. mains-side overcurrent protection	not required	not required
Approvals	KEMA, VDE	KEMA, VDE
Type of remote signalling contact	—	changeover contact



### DEHGuard M TT CI ... (FM)

Modular surge arrester with integrated backup fuses for TT and TN-S systems with a nominal voltage of 230 / 400 V ("3+1" circuit); FM version with floating remote signalling contact.

Type DG ...	M TT CI 275	M TT CI 275 FM
Part No.	952 322	952 327
SPD according to EN 61643-11 / IEC 61643-11	type 2 / class II	type 2 / class II
Max. continuous operating voltage (a.c.) [L-N] ( $U_C$ )	275 V (50 / 60 Hz)	275 V (50 / 60 Hz)
Nominal discharge current (8/20 $\mu$ s) [L-N] ( $I_n$ )	12.5 kA	12.5 kA
Max. discharge current (8/20 $\mu$ s) [L-N] ( $I_{max}$ )	25 kA	25 kA
Voltage protection level [L-N] / [N-PE] ( $U_P$ )	$\leq 1.5 / \leq 1.5$ kV	$\leq 1.5 / \leq 1.5$ kV
Max. mains-side overcurrent protection	not required	not required
Approvals	KEMA, VDE	KEMA, VDE
Type of remote signalling contact	—	changeover contact



### DEHGuard M TN CI ... (FM)

Modular surge arrester with integrated backup fuses for single-phase 230 V TN systems ("2-0" circuit); FM version with floating remote signalling contact.

Type DG ...	M TN CI 275	M TN CI 275 FM
Part No.	952 173	952 178
SPD according to EN 61643-11 / IEC 61643-11	type 2 / class II	type 2 / class II
Max. continuous operating voltage (a.c.) ( $U_C$ )	275 V (50 / 60 Hz)	275 V (50 / 60 Hz)
Nominal discharge current (8/20 $\mu$ s) ( $I_n$ )	12.5 kA	12.5 kA
Max. discharge current (8/20 $\mu$ s) ( $I_{max}$ )	25 kA	25 kA
Voltage protection level [L-PE] / [N-PE] ( $U_P$ )	$\leq 1.5 / \leq 1.5$ kV	$\leq 1.5 / \leq 1.5$ kV
Max. mains-side overcurrent protection	not required	not required
Approvals	KEMA, VDE	KEMA, VDE
Type of remote signalling contact	—	changeover contact



**DEHNGuard M TT 2P CI ... (FM)**

Modular surge arrester with integrated backup fuses for single-phase 230 V TT and TN systems ("1+1" circuits); FM version with floating remote signalling contact.



Type DG ...	M TT 2P CI 275	M TT 2P CI 275 FM
Part No.	952 171	952 176
SPD according to EN 61643-11 / IEC 61643-11	type 2 / class II	type 2 / class II
Max. continuous operating voltage (a.c.) [L-N] ( $U_c$ )	275 V (50 / 60 Hz)	275 V (50 / 60 Hz)
Nominal discharge current (8/20 $\mu$ s) [L-N] ( $I_n$ )	12.5 kA	12.5 kA
Max. discharge current (8/20 $\mu$ s) [L-N] ( $I_{max}$ )	25 kA	25 kA
Voltage protection level [L-N] / [N-PE] ( $U_p$ )	$\leq 1.5 / \leq 1.5$ kV	$\leq 1.5 / \leq 1.5$ kV
Max. mains-side overcurrent protection	not required	not required
Approvals	KEMA, VDE	KEMA, VDE
Type of remote signalling contact	—	changeover contact

**DEHNGuard S CI ... (FM)**

Pluggable single-pole surge arrester consisting of a base part and plug-in protection module; with integrated backup fuse; FM version with floating remote signalling contact.



Type DG ...	S CI 275	S CI 275 FM
Part No.	952 079	952 099
SPD according to EN 61643-11 / IEC 61643-11	type 2 / class II	type 2 / class II
Max. continuous operating voltage (a.c.) ( $U_c$ )	275 V (50 / 60 Hz)	275 V (50 / 60 Hz)
Nominal discharge current (8/20 $\mu$ s) ( $I_n$ )	12.5 kA	12.5 kA
Max. discharge current (8/20 $\mu$ s) ( $I_{max}$ )	25 kA	25 kA
Voltage protection level ( $U_p$ )	$\leq 1.5$ kV	$\leq 1.5$ kV
Max. mains-side overcurrent protection	not required	not required
Approvals	KEMA, VDE	KEMA, VDE
Type of remote signalling contact	—	changeover contact

**Accessories for DEHNGuard® modular with integrated Backup Fuse****Varistor-Based Protection Module for DEHNGuard M CI**

Protection module for DEHNGuard M ... CI 275 arresters comprising a varistor connected in series with the integrated backup fuse.



Type	DG MOD CI 275
Part No.	952 020
Max. continuous operating voltage (a.c.) ( $U_c$ )	275 V

**Varistor-Based Protection Module**

Varistor-based protection module for DEHNGuard M ... and DEHNGuard S ... surge arresters.



Type	DG MOD 275
Part No.	952 010
Max. continuous operating voltage (a.c.) ( $U_c$ )	275 V

**N-PE Spark-Gap-Based Protection Module for DEHNGuard M TT ...**

N-PE spark-gap-based protection module for two-pole and four-pole DEHNGuard DG M TT ... surge arresters.



Type	DG MOD NPE
Part No.	952 050
Max. continuous operating voltage (a.c.) ( $U_c$ )	255 V





## DEHNguard® modular

- Prewired complete unit consisting of a base part and plug-in protection modules
- Energy coordination with other arresters of the Red/Line product family
- High discharge capacity due to heavy-duty zinc oxide varistors / spark gaps
- High reliability due to “Thermo Dynamic Control” SPD monitoring device
- Easy replacement of protection modules without tools due to module locking system with module release button
- Vibration and shock-tested according to EN 60068-2



For protecting low-voltage consumer's installations against surges. For installation in conformity with the lightning protection zone concept at the boundaries from  $O_0 - 1$  and higher.

DEHNguard M TNC ...:	Modular surge arrester for use in TN-C systems
DEHNguard M TNS ...:	Modular surge arrester for use in TN-S systems
DEHNguard M TT ...:	Modular surge arrester for use in TT and TN-S systems (“3+1” circuits)
DEHNguard M TN ...:	Modular surge arrester for use in single-phase TN systems
DEHNguard M TT 2P ...:	Modular surge arrester for use in single-phase TT and TN systems (“1+1” circuits)
DEHNguard M WE ...:	Modular surge arrester especially for use in wind turbines
DEHNguard M ... FM:	With remote signalling contact for monitoring device (floating changeover contact)

Featuring the functional Red/Line family design, the modular DEHNguard M ... surge arresters set new standards in terms of safety and ease of use. The proven protective circuit with heavy-duty zinc oxide varistors in combination with the dual “Thermo Dynamic Control” monitoring device are characteristic of the DEHNguard technology.

A variety of features shows that both reliable surge protection and equipment safety are key elements of the modular DEHNguard surge arresters. The application-based product designation, which makes it considerably easier to choose the correct device for the relevant application, as well as the unique module locking system stand for fulfilling the most stringent safety requirements. The module locking system firmly fixes the protection modules to the base part. Neither vibration during transport nor the enormous forces of discharge can loosen the protection modules. Nevertheless, they can be easily replaced without tools by simply pressing the easy-to-use module release button of the protection modules. Each protective circuit of the multipole surge arresters and each protection module are mechanically coded to ensure against installing an incorrect module.

The dual “Thermo Dynamic Control” monitoring device was not only developed on the basis of national and international product standards, but also stands for experience of decades in the world market of surge protective devices and considers many practical applications where arresters

might be damaged. As with all DEHN surge arresters with “Thermo Dynamic Control”, the surface temperature of the heavy-duty varistor and the intensity of the discharge current are used for evaluation. The visual indicator with green and red indicator flags shows the availability of every protective circuit. Apart from this standard visual indication, DEHNguard M ... FM devices feature a three-pole remote signalling terminal.

With its floating changeover contact, the remote signal can be used as a make or break contract according to the particular circuit concept. The surge arresters of the modular multipole DEHNguard M family feature multifunctional terminals on a standardised spacing of 1 module for the connection of conductors and busbars, allowing easy wiring with other DIN rail mounted devices. Thus, a wide range of applications can be easily connected in series according to IEC 60364-5-53 for optimal protection.



### DEHNgard M TNC ...

Modular surge arrester for use in TN-C systems ("3-0" circuit).



Type DG M ...	TNC 150	TNC 275	TNC 385	TNC 440
Part No.	952 313	952 300	952 314	952 303
SPD according to EN 61643-11 / IEC 61643-11	type 2 / class II	type 2 / class II	type 2 / class II	type 2 / class II
Max. continuous operating voltage (a.c.) (U <sub>c</sub> )	150 V (50 / 60 Hz)	275 V (50 / 60 Hz)	385 V (50 / 60 Hz)	440 V (50 / 60 Hz)
Nominal discharge current (8/20 μs) (I <sub>n</sub> )	15 kA	20 kA	20 kA	20 kA
Max. discharge current (8/20 μs) (I <sub>max</sub> )	40 kA	40 kA	40 kA	40 kA
Voltage protection level (U <sub>p</sub> )	≤ 0.7 kV	≤ 1.5 kV	≤ 1.75 kV	≤ 2 kV
Max. mains-side overcurrent protection	125 A gG	125 A gG	125 A gG	125 A gG
Approvals	KEMA, UL	KEMA, VDE, UL	KEMA, UL	KEMA, UL

### DEHNgard M TNC ... FM

Modular surge arrester for use in TN-C systems ("3-0" circuit); with floating changeover contact.



Type DG M ...	TNC 150 FM	TNC 275 FM	TNC 385 FM	TNC 440 FM
Part No.	952 318	952 305	952 319	952 308
SPD according to EN 61643-11 / IEC 61643-11	type 2 / class II	type 2 / class II	type 2 / class II	type 2 / class II
Max. continuous operating voltage (a.c.) (U <sub>c</sub> )	150 V (50 / 60 Hz)	275 V (50 / 60 Hz)	385 V (50 / 60 Hz)	440 V (50 / 60 Hz)
Nominal discharge current (8/20 μs) (I <sub>n</sub> )	15 kA	20 kA	20 kA	20 kA
Max. discharge current (8/20 μs) (I <sub>max</sub> )	40 kA	40 kA	40 kA	40 kA
Voltage protection level (U <sub>p</sub> )	≤ 0.7 kV	≤ 1.5 kV	≤ 1.75 kV	≤ 2 kV
Max. mains-side overcurrent protection	125 A gG	125 A gG	125 A gG	125 A gG
Approvals	KEMA, UL	KEMA, VDE, UL	KEMA, UL	KEMA, UL
Type of remote signalling contact	changeover contact	changeover contact	changeover contact	changeover contact

### DEHNgard M TNS ...

Modular surge arrester for use in TN-S systems ("4-0" circuit).



Type DG M ...	TNS 150	TNS 275	TNS 385
Part No.	952 403	952 400	952 404
SPD according to EN 61643-11 / IEC 61643-11	type 2 / class II	type 2 / class II	type 2 / class II
Max. continuous operating voltage (a.c.) (U <sub>c</sub> )	150 V (50 / 60 Hz)	275 V (50 / 60 Hz)	385 V (50 / 60 Hz)
Nominal discharge current (8/20 μs) (I <sub>n</sub> )	15 kA	20 kA	20 kA
Max. discharge current (8/20 μs) (I <sub>max</sub> )	40 kA	40 kA	40 kA
Voltage protection level [L-PE]/[N-PE] (U <sub>p</sub> )	≤ 0.7 / ≤ 0.7 kV	≤ 1.5 / ≤ 1.5 kV	≤ 1.75 / ≤ 1.75 kV
Max. mains-side overcurrent protection	125 A gG	125 A gG	125 A gG
Approvals	KEMA, UL	KEMA, VDE, UL	KEMA, UL

### DEHNgard M TNS ... FM

Modular surge arrester for use in TN-S systems ("4-0" circuit); with floating changeover contact.



Type DG M ...	TNS 150 FM	TNS 275 FM	TNS 385 FM
Part No.	952 408	952 405	952 409
SPD according to EN 61643-11 / IEC 61643-11	type 2 / class II	type 2 / class II	type 2 / class II
Max. continuous operating voltage (a.c.) (U <sub>c</sub> )	150 V (50 / 60 Hz)	275 V (50 / 60 Hz)	385 V (50 / 60 Hz)
Nominal discharge current (8/20 μs) (I <sub>n</sub> )	15 kA	20 kA	20 kA
Max. discharge current (8/20 μs) (I <sub>max</sub> )	40 kA	40 kA	40 kA
Voltage protection level [L-PE]/[N-PE] (U <sub>p</sub> )	≤ 0.7 / ≤ 0.7 kV	≤ 1.5 / ≤ 1.5 kV	≤ 1.75 / ≤ 1.75 kV
Max. mains-side overcurrent protection	125 A gG	125 A gG	125 A gG
Approvals	KEMA, UL	KEMA, VDE, UL	KEMA, UL
Type of remote signalling contact	changeover contact	changeover contact	changeover contact

### DEHNgard M TT ...

Modular surge arrester for use in TT and TN-S systems ("3+1" circuit).



Type DG M ...	TT 150	TT 275	TT 320	TT 385
Part No.	952 323	952 310	952 320	952 311
SPD according to EN 61643-11 / IEC 61643-11	type 2 / class II	type 2 / class II	type 2 / class II	type 2 / class II
Max. continuous operating voltage (a.c.) [L-N] (U <sub>c</sub> )	150 V (50 / 60 Hz)	275 V (50 / 60 Hz)	320 V (50 / 60 Hz)	385 V (50 / 60 Hz)
Nominal discharge current (8/20 μs) (I <sub>n</sub> )	15 kA	20 kA	20 kA	20 kA
Max. discharge current (8/20 μs) (I <sub>max</sub> )	40 kA	40 kA	40 kA	40 kA
Voltage protection level [L-N]/[N-PE] (U <sub>p</sub> )	≤ 0.7 / ≤ 1.5 kV	≤ 1.5 / ≤ 1.5 kV	≤ 1.5 / ≤ 1.5 kV	≤ 1.75 / ≤ 1.5 kV
Max. mains-side overcurrent protection	125 A gG	125 A gG	125 A gG	125 A gG
Approvals	—	KEMA, VDE, UL	KEMA	KEMA, UL

### DEHNGuard M TT ... FM

Modular surge arrester for use in TT and TN-S systems ("3+1" circuit); with floating remote signalling contact.

Type DG M ...	TT 150 FM	TT 275 FM	TT 320 FM	TT 385 FM
Part No.	952 328	952 315	952 325	952 316
SPD according to EN 61643-11 / IEC 61643-11	type 2 / class II	type 2 / class II	type 2 / class II	type 2 / class II
Max. continuous operating voltage (a.c.) [L-N] ( $U_c$ )	150 V (50 / 60 Hz)	275 V (50 / 60 Hz)	320 V (50 / 60 Hz)	385 V (50 / 60 Hz)
Nominal discharge current (8/20 $\mu$ s) ( $I_n$ )	15 kA	20 kA	20 kA	20 kA
Max. discharge current (8/20 $\mu$ s) ( $I_{max}$ )	40 kA	40 kA	40 kA	40 kA
Voltage protection level [L-N]/[N-PE] ( $U_p$ )	$\leq 0.7 / \leq 1.5$ kV	$\leq 1.5 / \leq 1.5$ kV	$\leq 1.5 / \leq 1.5$ kV	$\leq 1.75 / \leq 1.5$ kV
Max. mains-side overcurrent protection	125 A gG	125 A gG	125 A gG	125 A gG
Approvals	—	KEMA, VDE, UL	KEMA	KEMA, UL
Type of remote signalling contact	changeover contact	changeover contact	changeover contact	changeover contact



### DEHNGuard M TN ...

Modular surge arrester for use in single-phase TN systems ("2-0" circuit).

Type DG M ...	TN 150	TN 275
Part No.	952 201	952 200
SPD according to EN 61643-11 / IEC 61643-11	type 2 / class II	type 2 / class II
Max. continuous operating voltage (a.c.) ( $U_c$ )	150 V (50 / 60 Hz)	275 V (50 / 60 Hz)
Nominal discharge current (8/20 $\mu$ s) ( $I_n$ )	15 kA	20 kA
Max. discharge current (8/20 $\mu$ s) ( $I_{max}$ )	40 kA	40 kA
Voltage protection level [L-PE]/[N-PE] ( $U_p$ )	$\leq 0.7 / \leq 0.7$ kV	$\leq 1.5 / \leq 1.5$ kV
Max. mains-side overcurrent protection	125 A gG	125 A gG
Approvals	KEMA, UL	KEMA, VDE, UL



### DEHNGuard M TN ... FM

Modular surge arrester for use in single-phase TN systems ("2-0" circuit); with floating remote signalling contact.

Type DG M ...	TN 150 FM	TN 275 FM
Part No.	952 206	952 205
SPD according to EN 61643-11 / IEC 61643-11	type 2 / class II	type 2 / class II
Max. continuous operating voltage (a.c.) ( $U_c$ )	150 V (50 / 60 Hz)	275 V (50 / 60 Hz)
Nominal discharge current (8/20 $\mu$ s) ( $I_n$ )	15 kA	20 kA
Max. discharge current (8/20 $\mu$ s) ( $I_{max}$ )	40 kA	40 kA
Voltage protection level [L-PE]/[N-PE] ( $U_p$ )	$\leq 0.7 / \leq 0.7$ kV	$\leq 1.5 / \leq 1.5$ kV
Max. mains-side overcurrent protection	125 A gG	125 A gG
Approvals	KEMA, UL	KEMA, VDE, UL
Type of remote signalling contact	changeover contact	changeover contact



### DEHNGuard M TT 2P ...

Modular surge arrester for use in single-phase TT and TN systems ("1+1" circuit).

Type DG M ...	TT 2P 275	TT 2P 320	TT 2P 385
Part No.	952 110	952 130	952 111
SPD according to EN 61643-11 / IEC 61643-11	type 2 / class II	type 2 / class II	type 2 / class II
Max. continuous operating voltage (a.c.) [L-N] ( $U_c$ )	275 V (50 / 60 Hz)	320 V (50 / 60 Hz)	385 V (50 / 60 Hz)
Nominal discharge current (8/20 $\mu$ s) ( $I_n$ )	20 kA	20 kA	20 kA
Max. discharge current (8/20 $\mu$ s) ( $I_{max}$ )	40 kA	40 kA	40 kA
Voltage protection level [L-N]/[N-PE] ( $U_p$ )	$\leq 1.5 / \leq 1.5$ kV	$\leq 1.5 / \leq 1.5$ kV	$\leq 1.75 / \leq 1.5$ kV
Max. mains-side overcurrent protection	125 A gG	125 A gG	125 A gG
Approvals	KEMA, VDE, UL	KEMA	KEMA



### DEHNGuard M TT 2P ... FM

Modular surge arrester for use in TT and TN systems ("1+1" circuit); with floating remote signalling contact.

Type DG M ...	TT 2P 275 FM	TT 2P 320 FM	TT 2P 385 FM
Part No.	952 115	952 135	952 116
SPD according to EN 61643-11 / IEC 61643-11	type 2 / class II	type 2 / class II	type 2 / class II
Max. continuous operating voltage (a.c.) [L-N] ( $U_c$ )	275 V (50 / 60 Hz)	320 V (50 / 60 Hz)	385 V (50 / 60 Hz)
Nominal discharge current (8/20 $\mu$ s) ( $I_n$ )	20 kA	20 kA	20 kA
Max. discharge current (8/20 $\mu$ s) ( $I_{max}$ )	40 kA	40 kA	40 kA
Voltage protection level [L-N]/[N-PE] ( $U_p$ )	$\leq 1.5 / \leq 1.5$ kV	$\leq 1.5 / \leq 1.5$ kV	$\leq 1.75 / \leq 1.5$ kV
Max. mains-side overcurrent protection	125 A gG	125 A gG	125 A gG
Approvals	KEMA, VDE, UL	KEMA	KEMA
Type of remote signalling contact	changeover contact	changeover contact	changeover contact



### DEHNguard M WE ... (FM)

Modular surge arrester ("3-0" circuit) with a rated varistor voltage  $U_{mov} = 750$  V a.c.; FM version with floating remote signalling contact.



Type DG M ...	WE 600	WE 600 FM
Part No.	952 302	952 307
SPD according to EN 61643-11 / IEC 61643-11	type 2 / class II	type 2 / class II
Max. continuous operating voltage (a.c.) ( $U_c$ )	600 V (50 / 60 Hz)	600 V (50 / 60 Hz)
Rated varistor voltage ( $U_{mov}$ )	750 V	750 V
Nominal discharge current (8/20 $\mu$ s) ( $I_n$ )	15 kA	15 kA
Max. discharge current (8/20 $\mu$ s) ( $I_{max}$ )	25 kA	25 kA
Voltage protection level ( $U_p$ )	$\leq 3$ kV	$\leq 3$ kV
Max. mains-side overcurrent protection	100 A gG	100 A gG
Approvals	KEMA, UL	KEMA, UL
Type of remote signalling contact	—	changeover contact

## Accessories for DEHNguard® modular

### Varistor-Based Protection Module

Varistor-based protection module for DEHNguard M ... and DEHNguard S ... surge arresters.



Type	DG MOD 150	DG MOD 275	DG MOD 320	DG MOD 385	DG MOD 440
Part No.	952 012	952 010	952 013	952 014	952 015
Max. continuous operating voltage (a.c.) ( $U_c$ )	150 V	275 V	320 V	385 V	440 V

### Varistor-Based Protection Module for DEHNguard M (S) WE

Varistor-based protection module for DEHNguard M WE ... and DEHNguard S WE ... surge arresters with a rated varistor voltage  $U_{mov} = 750$  V a.c.



Type	DG MOD 750
Part No.	952 017
Max. continuous operating voltage (a.c.) ( $U_c$ )	600 V

### N-PE Spark-Gap-Based Protection Module for DEHNguard M TT ...

N-PE spark-gap-based protection module for two-pole and four-pole DEHNguard DG M TT ... surge arresters.



Type	DG MOD NPE
Part No.	952 050
Max. continuous operating voltage (a.c.) ( $U_c$ )	255 V



## DEHNgard® S

- Multi-purpose surge arrester consisting of a base part and a plug-in protection module
- High discharge capacity due to heavy-duty zinc oxide varistor
- High reliability due to “Thermo Dynamic Control” SPD monitoring device
- Energy coordination with other arresters of the Red/Line product family
- Operating state / fault indication by green / red indicator flag in the inspection window
- Narrow (modular) design acc. to DIN 43880
- Multifunctional terminals for connecting conductors and busbars
- Easy replacement of protection modules due to module locking system with module release button
- Vibration and shock-tested according to EN 60068-2



For protecting low-voltage consumer's installations against surges. For installation in conformity with the lightning protection zone concept at the boundaries from  $0_B - 1$  and higher.

**DEHNgard S ...:** Pluggable surge arrester consisting of a base part and a plug-in protection module  
**DEHNgard S ... FM:** With remote signalling contact for monitoring device (floating changeover contact)

The universal features characterise the single-pole devices of the DEHNgard S product family. Whether as a single device or in combination with other devices – DEHNgard S surge arresters always provide adequate protection. The modern Red/Line family design and its universal features ensure safety and easy application for the user. The module release button and the approved “Thermo Dynamic Control” SPD monitoring device with dual tripping performance characterise the devices of the DEHNgard S series.

Experience of decades in the world market of surge arresters has further improved the latest DEHNgard generation compared to the previous devices.

The unique module locking system fixes the protection module to the base part. Neither vibration during transport nor the enormous forces of discharge can loosen this connection. Nevertheless, the modules can be easily replaced without tools by simply pressing the easy-to-use module release button of the protection modules.

Every base part and protection module is mechanically coded to ensure against installing an incorrect module.

As with all DEHNgard surge arresters, the user of DEHNgard S can rely on the dual “Thermo Dynamic Control” SPD monitoring device which ensures a maximum degree of safety, even under harsh environmental conditions. The green and red indicator flags show the operating state of DEHNgard S surge arresters. Apart from this standard visual indication, DEHNgard S ... FM features a three-pole remote signalling terminal. With its floating changeover contact, the remote signal can be used as a break or make contact according to the particular circuit concept. The multifunctional terminals of DEHNgard S surge arresters are suitable for connecting conductors and busbars, allowing easy wiring with other DIN rail mounted devices. Thus, a wide range of applications can be easily connected in series according to IEC 60364-5-53 for optimal protection.

### DEHNgard S ...

Pluggable single-pole surge arrester consisting of a base part and a plug-in protection module.

General technical data:				
SPD according to EN 61643-11 / IEC 61643-11	type 2 / class II			
Type DG S ...	48	75	150	275
Part No.	952 078	952 071	952 072	952 070
Max. continuous operating voltage (a.c.) ( $U_C$ )	48 V (50 / 60 Hz)	75 V (50 / 60 Hz)	150 V (50 / 60 Hz)	275 V (50 / 60 Hz)
Max. continuous operating voltage (d.c.) ( $U_C$ )	60 V	100 V	200 V	350 V
Nominal discharge current (8/20 $\mu$ s) ( $I_n$ )	7.5 kA	10 kA	15 kA	20 kA
Max. discharge current (8/20 $\mu$ s) ( $I_{max}$ )	25 kA	40 kA	40 kA	40 kA
Voltage protection level ( $U_P$ )	$\leq 0.33$ kV	$\leq 0.4$ kV	$\leq 0.7$ kV	$\leq 1.5$ kV
Max. mains-side overcurrent protection	125 A gG	125 A gG	125 A gG	125 A gG
Approvals	— KEMA, VDE, UL, CSA			
Type DG S ...	320	385	440	600
Part No.	952 073	952 074	952 075	952 076
Max. continuous operating voltage (a.c.) ( $U_C$ )	320 V (50 / 60 Hz)	385 V (50 / 60 Hz)	440 V (50 / 60 Hz)	600 V (50 / 60 Hz)
Max. continuous operating voltage (d.c.) ( $U_C$ )	420 V	500 V	585 V	600 V
Nominal discharge current (8/20 $\mu$ s) ( $I_n$ )	20 kA	20 kA	20 kA	15 kA
Max. discharge current (8/20 $\mu$ s) ( $I_{max}$ )	40 kA	40 kA	40 kA	30 kA
Voltage protection level ( $U_P$ )	$\leq 1.5$ kV	$\leq 1.75$ kV	$\leq 2$ kV	$\leq 2.5$ kV
Max. mains-side overcurrent protection	125 A gG	125 A gG	125 A gG	100 A gG
Approvals	— KEMA, VDE, UL, CSA			



**DEHNgard S ... FM**

Pluggable single-pole surge arrester consisting of a base part and a plug-in protection module; with floating remote signalling contact.

General technical data:				
SPD according to EN 61643-11 / IEC 61643-11	type 2 / class II			
Type of remote signalling contact	changeover contact			
Type DG S ...	48 FM	75 FM	150 FM	275 FM
Part No.	952 098	952 091	952 092	952 090
Max. continuous operating voltage (a.c.) (U <sub>c</sub> )	48 V (50 / 60 Hz)	75 V (50 / 60 Hz)	150 V (50 / 60 Hz)	275 V (50 / 60 Hz)
Max. continuous operating voltage (d.c.) (U <sub>c</sub> )	60 V	100 V	200 V	350 V
Nominal discharge current (8/20 μs) (I <sub>n</sub> )	7.5 kA	10 kA	15 kA	20 kA
Max. discharge current (8/20 μs) (I <sub>max</sub> )	25 kA	40 kA	40 kA	40 kA
Voltage protection level (U <sub>p</sub> )	≤ 0.33 kV	≤ 0.4 kV	≤ 0.7 kV	≤ 1.5 kV
Max. mains-side overcurrent protection	125 A gG	125 A gG	125 A gG	125 A gG
Approvals	— KEMA, VDE, UL, CSA			
Type DG S ...	320 FM	385 FM	440 FM	600 FM
Part No.	952 093	952 094	952 095	952 096
Max. continuous operating voltage (a.c.) (U <sub>c</sub> )	320 V (50 / 60 Hz)	385 V (50 / 60 Hz)	440 V (50 / 60 Hz)	600 V (50 / 60 Hz)
Max. continuous operating voltage (d.c.) (U <sub>c</sub> )	420 V	500 V	585 V	600 V
Nominal discharge current (8/20 μs) (I <sub>n</sub> )	20 kA	20 kA	20 kA	15 kA
Max. discharge current (8/20 μs) (I <sub>max</sub> )	40 kA	40 kA	40 kA	30 kA
Voltage protection level (U <sub>p</sub> )	≤ 1.5 kV	≤ 1.75 kV	≤ 2 kV	≤ 2.5 kV
Max. mains-side overcurrent protection	125 A gG	125 A gG	125 A gG	100 A gG
Approvals	KEMA, VDE, UL, CSA			



**DEHNgard S WE 600 (FM)**

Pluggable single-pole surge arrester with a rated varistor voltage U<sub>mov</sub> = 750 V a.c., consisting of base part and a plug-in protection module; FM version with floating remote signalling contact.

Type DG S ...	WE 600	WE 600 FM
Part No.	952 077	952 097
SPD according to EN 61643-11 / IEC 61643-11	type 2 / class II	type 2 / class II
Max. continuous operating voltage (a.c.) (U <sub>c</sub> )	600 V (50 / 60 Hz)	600 V (50 / 60 Hz)
Nominal discharge current (8/20 μs) (I <sub>n</sub> )	15 kA	15 kA
Max. discharge current (8/20 μs) (I <sub>max</sub> )	25 kA	25 kA
Voltage protection level (U <sub>p</sub> )	≤ 3 kV	≤ 3 kV
Max. mains-side overcurrent protection	100 A gG	100 A gG
Approvals	KEMA, UL, CSA	KEMA, UL, CSA
Type of remote signalling contact	—	changeover contact



**Accessories for DEHNgard® S**

**Varistor-Based Protection Module**

Varistor-based protection module for DEHNgard M ... and DEHNgard S ... surge arresters.

Type	DG MOD 48	DG MOD 75	DG MOD 150	DG MOD 275
Part No.	952 018	952 011	952 012	952 010
Max. continuous operating voltage (a.c.) (U <sub>c</sub> )	48 V	75 V	150 V	275 V
Type	DG MOD 320	DG MOD 385	DG MOD 440	DG MOD 600
Part No.	952 013	952 014	952 015	952 016
Max. continuous operating voltage (a.c.) (U <sub>c</sub> )	320 V	385 V	440 V	600 V



**Varistor-Based Protection Module for DEHNgard M (S) WE**

Varistor-based protection module for DEHNgard M WE ... and DEHNgard S WE ... surge arresters with a rated varistor voltage U<sub>mov</sub> = 750 V a.c.

Type	DG MOD 750
Part No.	952 017
Max. continuous operating voltage (a.c.) (U <sub>c</sub> )	600 V





## DEHNguard® S ... VA

### Pluggable single-pole varistor-based arrester

- Multi-purpose surge arrester consisting of a base part and plug-in protection module
- Leakage-current-free series connection of a varistor and a spark gap in the pluggable protection module
- High reliability due to “Thermo Dynamic Control” SPD monitoring device
- Energy coordination with other arresters of the Red/Line product family
- Easy replacement of protection modules without tools due to module locking system with module release button
- Narrow (modular) design according to DIN 43880
- Multifunctional terminal for connecting conductors and busbars

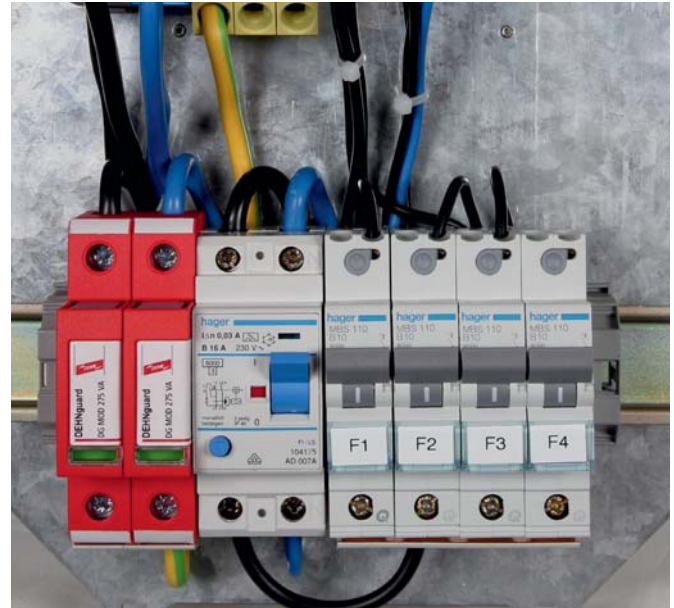

For protecting low-voltage consumer's installations against surges. For installation in conformity with the lightning protection zone concept at the boundaries from  $O_B - 1$  and higher.

**DEHNguard S ... VA:** Modular single-pole surge arrester with a varistor connected in series with a spark gap in the pluggable protection module

**DEHNguard S ... VA FM:** Modular single-pole surge arrester with a varistor connected in series with a spark gap in the pluggable protection module; with remote signalling contact for monitoring device (floating changeover contact)

The single-pole DEHNguard S ... VA surge arresters are an ideal supplement to the proven DEHNguard product families. The special series connection of a spark gap and a varistor in the protection module opens up new fields of application. It is advisable to use DEHNguard S ... VA devices to protect, for example, systems with permanent insulation monitoring and the traction power lines in railway systems where complete absence of leakage currents is required. DEHNguard S ... VA surge arresters are also suited for protecting power line communication systems.

Multifunctional terminals allow almost unlimited flexibility of connection to one another, but also to other DIN rail mounted devices on the distribution board. However, it is not only flexibility that characterises the DEHNguard S ... VA family. Its distinctive performance parameters set standards worldwide:

A high discharge capacity, complete absence of leakage currents, a low voltage protection level and the dual “Thermo Dynamic Control” monitoring and disconnection device describe the high degree of reliability.

The DEHN-specific “Thermo Dynamic Control” disconnecter ensures that the arresters enter a safe and isolated state, even in case of extreme overload. For this purpose, the surface temperature of the heavy-duty varistor and the intensity of the discharge current are used for evaluation. In addition to the standard visual indication with red and green indicator flags, the DEHNguard S VA ... FM devices feature a three-pole remote signalling terminal. With its floating changeover contact, the remote signal can be used as break or make contact according to the particular protection concept.

### DEHNguard S VA

Modular single-pole surge arrester with a varistor connected in series with a spark gap in a pluggable protection module.



Type DG S ...	75 VA	275 VA	385 VA
Part No.	952 080	952 082	952 084
SPD according to EN 61643-11 / IEC 61643-11	type 2 / class II	type 2 / class II	type 2 / class II
Max. continuous operating voltage (a.c.) (U <sub>c</sub> )	75 V (50 / 60 Hz)	275 V (50 / 60 Hz)	385 V (50 / 60 Hz)
Nominal discharge current (8/20 μs) (I <sub>n</sub> )	10 kA	10 kA	10 kA
Max. discharge current (8/20 μs) (I <sub>max</sub> )	20 kA	20 kA	20 kA
Voltage protection level (U <sub>p</sub> )	≤ 1.1 kV	≤ 1.5 kV	≤ 1.75 kV
Max. mains-side overcurrent protection	100 A gG	100 A gG	100 A gG

### DEHNguard S VA FM

Modular single-pole surge arrester with a varistor connected in series with a spark gap in a pluggable protection module; with floating remote signalling contact.



Type DG S ...	75 VA FM	275 VA FM	385 VA FM
Part No.	952 085	952 087	952 089
SPD according to EN 61643-11 / IEC 61643-11	type 2 / class II	type 2 / class II	type 2 / class II
Max. continuous operating voltage (a.c.) (U <sub>c</sub> )	75 V (50 / 60 Hz)	275 V (50 / 60 Hz)	385 V (50 / 60 Hz)
Nominal discharge current (8/20 μs) (I <sub>n</sub> )	10 kA	10 kA	10 kA
Max. discharge current (8/20 μs) (I <sub>max</sub> )	20 kA	20 kA	20 kA
Voltage protection level (U <sub>p</sub> )	≤ 1.1 kV	≤ 1.5 kV	≤ 1.75 kV
Max. mains-side overcurrent protection	100 A gG	100 A gG	100 A gG

## Accessories for DEHNguard® S ... VA

### Varistor-Based Protection Module for DEHNguard S ... VA

Protection module for DEHNguard S ... VA arresters comprising a varistor connected in series with a spark gap.



Type	DG MOD 75 VA	DG MOD 275 VA	DG MOD 385 VA
Part No.	952 025	952 027	952 029
Max. continuous operating voltage (a.c.) (U <sub>c</sub> )	75 V	275 V	385 V





## DEHNgard® SE H LI ... FM

- Universal surge arrester comprising a base part and a plug-in protection module
- Prewired single-pole surge arrester with clear “Lifetime Indication”
- Three-step “Lifetime Indication” (green-yellow-red) linked with remote signalling contact
- High discharge capacity  $I_{max}$  up to 65 kA (8/20  $\mu$ s)
- Prompts the user in time <YELLOW> to replace the protection module in case of imminent arrester overload; early warning system
- The arrester is fully operational until the protection module is replaced and is thus suited for use in condition monitoring systems
- Energy coordination with other arresters of the Red/Line product family
- Easy replacement of protection modules without tools due to module locking system with module release button

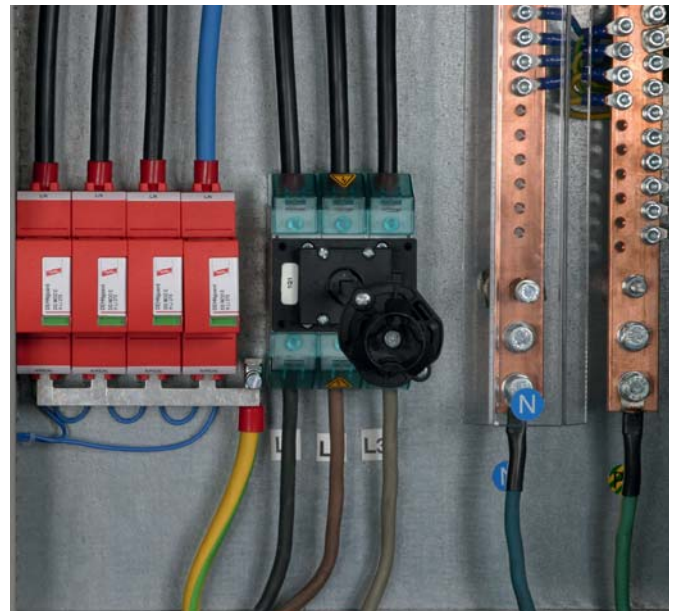

Single-pole surge arrester with integrated “Lifetime Indication” early warning system. For protecting low-voltage consumer’s installations from surges. For installation in conformity with the lightning protection zone concept at the boundaries from  $0_B - 1$  and higher.

- DEHNgard SE H LI ... FM:** Pluggable single-pole surge arrester with three-step early warning system (green-yellow-red) comprising a base part and a plug-in protection module; with remote signalling contact for monitoring unit (floating changeover contact)
- DEHNgard SE H 1000 FM:** Pluggable single-pole surge arrester with a high discharge capacity comprising a base part and a plug-in protection module; with remote signalling contact for monitoring unit (floating changeover contact)

The single-pole type 2 DEHNgard SE H LI ... FM surge arresters with a functional Red/Line design provide a high degree of safety and comfort and ensure maximum availability of electrical installations.

The three-step “Lifetime Indication” provides reliable information on the operating state of the surge protective device. The yellow indication shows that a certain energy has pre-damaged the arrester during its lifetime. Moreover, the remote signalling contact is activated so that the arrester can be easily integrated condition monitoring systems. During this yellow indication, the connected electrical equipment is still protected against surges since the protection module is fully operational. Now the protection module can be replaced in time (without disconnecting the mains voltage and removing the distribution board cover) – Before further energies overload the arrester and the installation is unprotected! Thus, the lifetime between commissioning (green indication) and disconnection (red indication) of DEHNgard SE H LI ... FM consists of two periods: After typically 70% of the total nominal discharge current load, the indication changes from green to yellow. Consequently, about 30% of the total load capacity remain for the yellow phase during which the surge protective device is fully operational. This makes this indication an ideal early warning system!

The single-pole devices are available for voltages from 275 V to 1000 V a.c. and are thus universally applicable. In addition, the product family has a high discharge capacity  $I_{max}$  up to 65 kA (8/20  $\mu$ s) and is thus more powerful across all voltage levels than conventional type 2 arresters.

The devices feature the special modular Red/Line family design with a width of 1.5 modules to implement the variety of functions. They can be used as a single device or in combination with other devices and always provide adequate protection. All necessary components such as earthing clips EB 1 ... 1.5 with modular dimensions of 1.5 modules are avail-

able as accessory to ensure the correct connection for the relevant system configuration as per IEC 60364-5-53.

Consequently, the intelligent DEHNgard SE H LI ... FM family allows to protect installations which require maximum availability such as data centres, power plants or wind turbines against surges. Planned maintenance for type 2 surge protective devices can be easily and efficiently performed in all low-voltage installations.

Both the three-step monitoring unit of the surge protective devices and the coded plug-in protection module types underline the high degree of safety of the arrester and damage caused by installing an incorrect module can be virtually excluded.

In addition to the standard three-step visual indication, the arresters feature a three-pole remote signalling terminal. With its floating changeover contact, the remote signal can be used as a break or make contact according to the particular circuit concept.

The DEHNgard SE H 1000 FM type is a special arrester of the DEHNgard ... H ... series. Compared to the LI devices, whose designation includes the abbreviation “LI”, it features a two-step visual indication which changes from green to red as soon as the max. load capacity of the arrester is reached and activates the floating changeover contact.

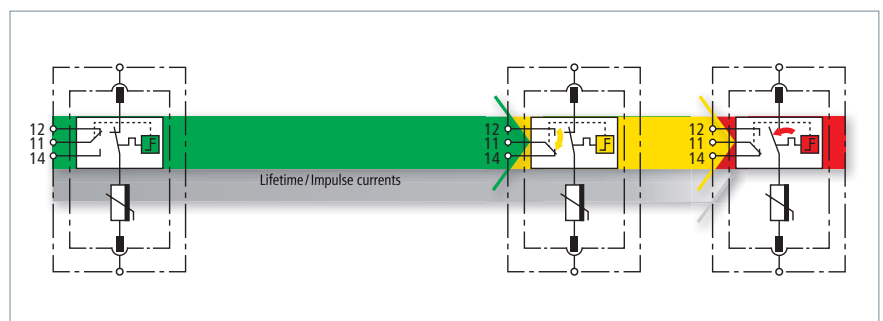

**DEHNguard SE H LI ... FM**

Pluggable single-pole surge arrester with three-step early warning system (green-yellow-red) consisting of a base part and a plug-in protection module; with floating remote signalling contact.

General technical data:			
SPD according to EN 61643-11 / IEC 61643-11	type 2 / class II		
Operating state / fault indication	green / yellow / red		
Type of remote signalling contact	changeover contact		
Type DG SE H ...	LI 275 FM	LI 320 FM	LI 385 FM
Part No.	952 930	952 933 <sup>NEW</sup>	952 934 <sup>NEW</sup>
Max. continuous operating voltage (a.c.) (U <sub>c</sub> )	275 V (50 / 60 Hz)	320 V (50 / 60 Hz)	385 V (50 / 60 Hz)
Nominal discharge current (8/20 μs) (I <sub>n</sub> )	30 kA	30 kA	30 kA
Max. discharge current (8/20 μs) (I <sub>max</sub> )	65 kA	65 kA	65 kA
Voltage protection level (U <sub>p</sub> )	≤ 1.5 kV	≤ 1.75 kV	≤ 2.0 kV
Max. mains-side overcurrent protection	125 A gG	125 A gG	125 A gG
Type DG SE H ...	LI 440 FM	LI 1000 FM	
Part No.	952 935 <sup>NEW</sup>	952 937	
Max. continuous operating voltage (a.c.) (U <sub>c</sub> )	440 V (50 / 60 Hz)	1000 V (50 / 60 Hz)	
Nominal discharge current (8/20 μs) (I <sub>n</sub> )	30 kA	20 kA	
Max. discharge current (8/20 μs) (I <sub>max</sub> )	65 kA	40 kA	
Voltage protection level (U <sub>p</sub> )	≤ 2.25 kV	≤ 4.5 kV	
Max. mains-side overcurrent protection	125 A gG	100 A gG	

**NEW****DEHNguard SE H 1000 FM**

Pluggable single-pole surge arrester comprising a base part and a plug-in protection module; with floating remote signalling contact.

Type DG SE H ...	1000 FM
Part No.	952 938 <sup>NEW</sup>
SPD according to EN 61643-11 / IEC 61643-11	type 2 / class II
Max. continuous operating voltage (a.c.) (U <sub>c</sub> )	1000 V (50 / 60 Hz)
Nominal discharge current (8/20 μs) (I <sub>n</sub> )	20 kA
Max. discharge current (8/20 μs) (I <sub>max</sub> )	40 kA
Voltage protection level (U <sub>p</sub> )	≤ 4.5 kV
Max. mains-side overcurrent protection	100 A gG
Operating state / fault indication	green / red
Type of remote signalling contact	changeover contact

**NEW****Accessories for DEHNguard® SE H LI ... FM****Varistor-based Protection Module for DEHNguard SE H LI ... FM**

Varistor-based protection module for DEHNguard SE H LI ... FM

Type	DG MOD E H LI 275	DG MOD E H LI 320	DG MOD E H LI 385
Part No.	952 900	952 903 <sup>NEW</sup>	952 904 <sup>NEW</sup>
Max. continuous operating voltage (d.c.) (U <sub>c</sub> )	275 V	320 V	385 V
Type	DG MOD E H LI 440	DG MOD E H LI 1000	DG MOD E H 1000
Part No.	952 905 <sup>NEW</sup>	952 907	952 908 <sup>NEW</sup>
Max. continuous operating voltage (d.c.) (U <sub>c</sub> )	440 V	1000 V	1000 V

**NEW****Earthing Clip for 1.5-module Enclosures, single-phase, two-pole / three-pole / four-pole**

Earthing clip for connecting the earth terminal of e.g. two / three / four SPDs with 1.5-module enclosure and terminal to earth.

Type	EB 1 2 1.5	EB 1 3 1.5	EB 1 4 1.5
Part No.	900 460	900 418	900 429
Dimensions	34 x 60 x 28 mm	34 x 85 x 28 mm	34 x 112 x 28 mm
Clamp	up to 25 mm <sup>2</sup>	up to 25 mm <sup>2</sup>	up to 25 mm <sup>2</sup>





## DEHNcord

### Flexible surge protection

- Two-pole or single-pole surge protective device with monitoring system and disconnector
- Visual fault indication
- Compact design
- For use in flush-mounted systems, cable ducts and flush-type boxes



For protecting electronic devices (e.g. LED lights) from surges. For flexible installation in electrical installation systems such as flush-type boxes, flush-mounted systems, cable ducts and wall boxes. For installation in conformity with the lightning protection zone concept at the boundaries from  $0_B - 1$  and higher.

**DEHNcord L 2P ...:** Compact two-pole version; for use in flush-type boxes, flush-mounted systems and cable ducts

**DEHNcord L 1P ...:** Compact single-pole version; for use in flush-type boxes, flush-mounted systems and cable ducts

The DEHNcord series can be flexibly used as type 2 surge arrester, thus offering a variety of different application options. Compact in design, the surge arresters are ideally suited for protecting electrical and electronic loads in final circuits where the performance of a standard type 3 surge protective device for terminal equipment reaches its limits. A possible field of application is the protection of outdoor LED lights. DEHNcord is classed a type 2 surge arrester and can therefore be installed according to the lightning protection zones concept at the transition from  $0_B - 1$  and

higher. This ensures proper installation of surge protective devices where space is limited. The design is adapted to the preferred places of installation, namely cable ducts and flush-type boxes. In addition to the powerful protective circuit, the compact enclosure of the DEHNcord devices also houses a disconnector and a mechanical operating state / fault indicator. Be it in cable ducts, flush-mounted systems, junction boxes or device casings: There is always enough space for DEHNcord in the relevant installation environment.

### DEHNcord L 2P

Multipole surge arrester for all installation systems ("1+1" circuit); compact design (49 x 50 x 20.6 mm).

Type DCOR L ...	2P 275	2P 320
Part No.	900 430	900 432
SPD according to EN 61643-11 / IEC 61643-11	type 2 / class II	type 2 / class II
Max. continuous operating voltage (a.c.) [L-N] ( $U_C$ )	275 V (50 / 60 Hz)	320 V (50 / 60 Hz)
Nominal discharge current (8/20 $\mu$ s) ( $I_n$ )	5 kA	5 kA
Max. discharge current (8/20 $\mu$ s) ( $I_{max}$ )	10 kA	10 kA
Voltage protection level [L-N] ( $U_P$ )	$\leq 1.5$ kV	$\leq 1.75$ kV
Voltage protection level [N-PE] ( $U_P$ )	$\leq 1.5$ kV	$\leq 1.5$ kV
Max. mains-side overcurrent protection	25 A gG	25 A gG
Approvals	KEMA	KEMA

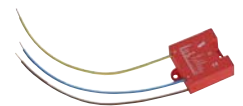

### DEHNcord L 1P

Single-pole surge arrester for all installation systems; compact design (49 x 50 x 20.6 mm).

Type DCOR L ...	1P 275	1P 320
Part No.	900 431	900 433
SPD according to EN 61643-11 / IEC 61643-11	type 2 / class II	type 2 / class II
Max. continuous operating voltage (a.c.) [L-N] ( $U_C$ )	275 V (50 / 60 Hz)	320 V (50 / 60 Hz)
Nominal discharge current (8/20 $\mu$ s) ( $I_n$ )	5 kA	5 kA
Max. discharge current (8/20 $\mu$ s) ( $I_{max}$ )	10 kA	10 kA
Voltage protection level [L-N] ( $U_P$ )	$\leq 1.5$ kV	$\leq 1.75$ kV
Max. mains-side overcurrent protection	25 A gG	25 A gG
Approvals	KEMA	KEMA





## DEHNgap C S

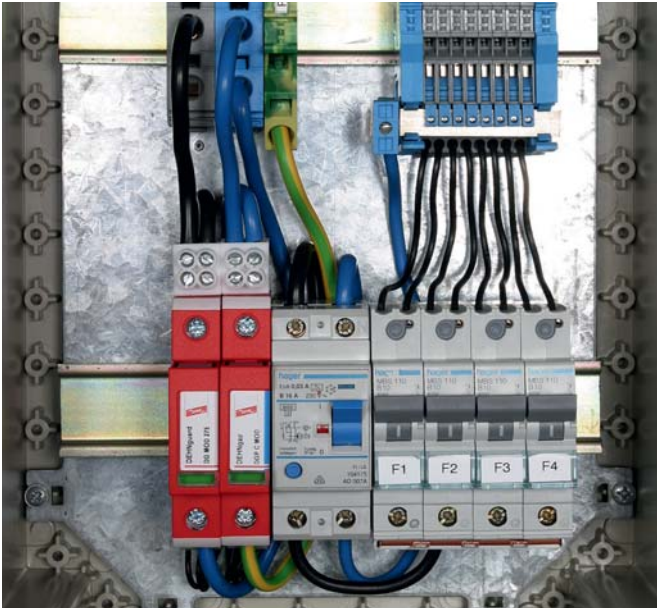

For protecting low-voltage consumer's installations against surges. For installation in conformity with the lightning protection zone concept at the boundaries from  $O_B - 1$  and higher.

**DEHNgap C S:** N-PE surge arrester consisting of a base part and a plug-in protection module  
**DEHNgap C S FM:** With remote signalling contact for monitoring device (floating changeover contact)

The N-PE surge arresters of type DEHNgap C S are an ideal supplement for the single-pole DEHNgard S surge protective devices. Being total current arresters between the neutral and protective conductor in TT systems, DEHNgap C S surge arresters help to ensure fulfilling the requirements for protecting personnel and equipment in "3+1" and "1+1" circuits.

With their modern Red/Line design, DEHNgap C S surge arresters have exactly the same easy-to-use safety features as the DEHNgard S devices. The unique module locking system combines the spark-gap-based protection module and the base part to a powerful unit. Neither vibration during transport nor the enormous forces of discharge can loosen this connection. Nevertheless, the protection modules can be easily replaced without tools by simply pressing the easy-to-use module release button of the protection module. The mechanical coding of the protection module and base part ensures against installing an incorrect module.

## N-PE surge arrester

- Specifically designed for use in "3+1" and "1+1" circuits of TT systems acc. to IEC 60364-5-53 between neutral conductor N and protective conductor PE
- High discharge capacity
- Two-part surge arrester consisting of a base part and a pluggable spark-gap-based protection module
- Energy coordination with other arresters of the Red/Line product family
- Operating state / fault indication by green / red indicator flag in the inspection window
- With remote signalling contact for monitoring device
- Easy replacement of protection modules without tools due to module locking system with module release button
- Vibration and shock-tested according to EN 60068-2

Safety of DEHNgap C S surge arresters is increased by monitoring the arrester temperature and an integrated disconnecter connected in series with the surge arrester.

The green and red indicator flags show the operating state of DEHNgap C S surge arresters.

Apart from this standard visual indication, DEHNgap C S ... FM features a three-pole remote signalling terminal. With its floating changeover contact, the remote signal can be used as a break or make contact according to the particular circuit concept. The N-PE surge arresters of type DEHNgap C S incorporate multifunctional terminals for connecting conductors and busbars, allowing easy wiring with other DIN rail mounted devices. Thus, a variety of applications can be easily connected in series according to IEC 60364-5-53 for optimal protection.

## DEHNgap C S (FM)

N-PE surge arrester; FM version with floating remote signalling contact.

Type DGP C ...	S	S FM
Part No.	952 030	952 035
SPD according to EN 61643-11 / IEC 61643-11	type 2 / class II	type 2 / class II
Max. continuous operating voltage (a.c.) ( $U_C$ )	255 V (50 / 60 Hz)	255 V (50 / 60 Hz)
Nominal discharge current (8/20 $\mu$ s) ( $I_n$ )	20 kA	20 kA
Max. discharge current (8/20 $\mu$ s) ( $I_{max}$ )	40 kA	40 kA
Voltage protection level ( $U_p$ )	$\leq 1.5$ kV	$\leq 1.5$ kV
Approvals	KEMA, VDE, UL	KEMA, VDE, UL
Type of remote signalling contact	—	changeover contact

## Accessories for DEHNgap C S

## N-PE Spark-Gap-Based Protection Module for DEHNgap C S

N-PE spark-gap-based protection module for single-pole N-PE surge arresters of type DEHNgap DGP C S ... .

Type	DGP C MOD
Part No.	952 060
Max. continuous operating voltage (a.c.) ( $U_C$ )	255 V



## DEHNgard® SE DC ... (FM)

### Modular single-pole surge arrester for d.c. applications

- Universal single-pole surge arrester consisting of a base part and a plug-in protection module
- Device concept specifically developed for use in d.c. circuits
- Powerful switching device DCD prevents fire damage caused by d.c. switching arcs
- Use without additional backup fuse in defined applications
- Operating state / fault indication by green / red indicator flag in the inspection window
- Easy replacement of protection modules without tools due to module locking system with module release button

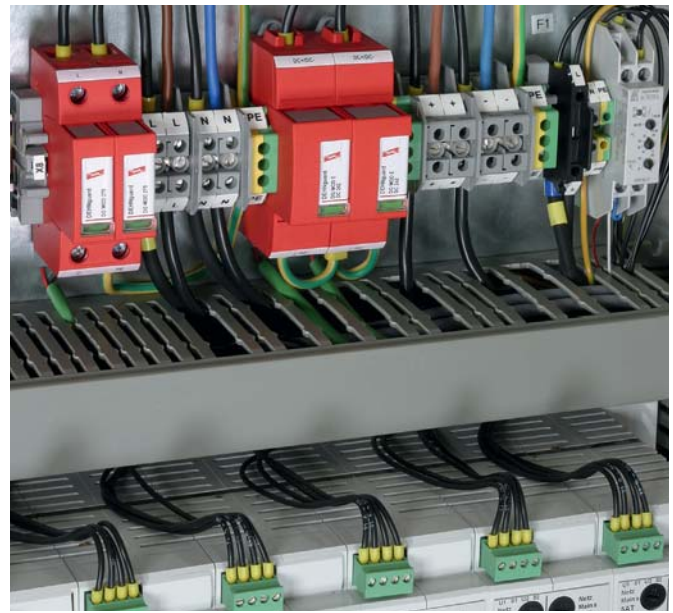

For protecting low-voltage consumer's installations against surges. For installation in conformity with the lightning protection zone concept at the boundaries from  $O_B - 1$  and higher.

DEHNgard SE DC ...: Modular single-pole surge arrester for d.c. applications  
 DEHNgard SE DC ... FM: With remote signalling contact for monitoring device (floating changeover contact)

The modular devices of the DEHNgard SE DC product series are coordinated single-pole type 2 surge arresters with a functional design. When developing this device series for protecting d.c. systems, the main focus was on the increased requirements of d.c. applications with regard to device safety in all operating states. The extremely powerful d.c. switching device DCD, which prevents fire damage caused by switching arcs, is the core of the DEHNgard SE DC devices.

DEHNgard SE DC ... (FM) is coordinated with DEHNsecure ... (FM) type 1 lightning current arresters (minimum decoupling length of 1 m must be observed).

The DEHNgard SE DC devices combine high performance and ease of use in a single device. Their electrical parameters are rated for the most stringent requirements within lightning and surge protection systems. The high number of features shows that the main focus is both on reliable surge protection and device safety.

Proven heavy-duty varistors are used to discharge high impulse currents and limit the destructive surge impulses to the specified voltage protection level values. The operating state of the arrester is permanently monitored via the surface temperature of the heavy-duty varistor and the d.c. switching device DCD is immediately activated in case of overload. The mechanical visual indicator with green and red indicator flags, which is available for each protective path, is directly connected to the d.c. switching device DCD. When the red indication appears in the inspection window, the d.c. switching device DCD has already safely interrupted the d.c.

switching arc and thus reliably prevented fire damage. In case of the DEHNgard SE DC ... FM version, the arrester status can be additionally indicated via a three-pole remote signalling terminal.

The special design of the d.c. switching device DCD even ensures a short-circuit withstand capability up to 300 A d.c. – without arrester backup fuse (!). In combination with the specified backup fuses, the short-circuit withstand capability can be even increased to 25.000 A d.c., which is certainly an innovation in the field of d.c. applications.

The single-pole devices are available for voltages from 60 V to 900 V d.c. and can thus be used for a variety of applications such as emergency power supply systems, d.c. systems for direct supply of d.c. drives, control circuits and battery-operated supply systems of any kind.

To implement these numerous features, the devices incorporate the modular Red/Line family design with a width of 1.5 modules. The mechanical design of the connection points is another safety feature. The covered screws provide additional shock protection and the projections for easily and safely entering the cable increase clearances and creepage distances so that no distance to other equipment must be maintained even in case of voltages up to 900 V d.c.

The coded plug-in protection modules ensure a high degree of protection. Consequently, damage caused by installing an incorrect module can be virtually excluded.

### DEHNgard SE DC ...

Modular single-pole surge arrester for d.c. applications.



Type DG SE DC ...	60	242	550	900
Part No.	972 110	972 120	972 130	972 140
SPD classification according to EN 61643-11 / IEC 61643-11	type 2 / class II	type 2 / class II	type 2 / class II	type 2 / class II
Max. continuous operating voltage (d.c.) ( $U_c$ )	60 V	242 V	550 V	900 V
Nominal discharge current (8/20 $\mu$ s) ( $I_n$ )	12.5 kA	12.5 kA	12.5 kA	12.5 kA
Voltage protection level ( $U_p$ )	$\leq 0.5$ kV	$\leq 1.25$ kV	$\leq 2.0$ kV	$\leq 3.0$ kV
Short-circuit withstand capability without backup fuse (d.c.) ( $I_{SCCR}$ )	300 A	300 A	200 A	100 A
Short-circuit withstand capability for max. mains-side overcurrent protection (d.c.) ( $I_{SCCR}$ )	25 kA	25 kA	25 kA	25 kA
Max. mains-side overcurrent protection	35 A gG	35 A gG	35 A gG	80 A gG

### DEHNgard SE DC ... FM

Modular single-pole surge arrester for d.c. applications; with floating remote signalling contact.



Type DG SE DC ...	60 FM	242 FM	550 FM	900 FM
Part No.	972 115	972 125	972 135	972 145
SPD classification according to EN 61643-11 / IEC 61643-11	type 2 / class II	type 2 / class II	type 2 / class II	type 2 / class II
Max. continuous operating voltage (d.c.) ( $U_c$ )	60 V	242 V	550 V	900 V
Nominal discharge current (8/20 $\mu$ s) ( $I_n$ )	12.5 kA	12.5 kA	12.5 kA	12.5 kA
Voltage protection level ( $U_p$ )	$\leq 0.5$ kV	$\leq 1.25$ kV	$\leq 2.0$ kV	$\leq 3.0$ kV
Short-circuit withstand capability without backup fuse (d.c.) ( $I_{SCCR}$ )	300 A	300 A	200 A	100 A
Short-circuit withstand capability for max. mains-side overcurrent protection (d.c.) ( $I_{SCCR}$ )	25 kA	25 kA	25 kA	25 kA
Max. mains-side overcurrent protection	35 A gG	35 A gG	35 A gG	80 A gG
Type of remote signalling contact	changeover contact	changeover contact	changeover contact	changeover contact

## Accessories for DEHNgard® SE DC ... (FM)

### Varistor-based Protection Module for DEHNgard SE DC

Varistor-based protection module for DEHNgard SE DC



Type	DG MOD E DC 60	DG MOD E DC 242	DG MOD E DC 550	DG MOD E DC 900
Part No.	972 010	972 020	972 030	972 040
Max. continuous operating voltage (d.c.) ( $U_c$ )	60 V	242 V	550 V	900 V

### Earthing Clip for 1.5-module Enclosures, single-phase, two-pole

Earthing clip for connecting the earth terminal of e.g. two SPDs with 1.5-module enclosure and terminal to earth.



Type	EB 1 2 1.5
Part No.	900 460
Dimensions	34 x 60 x 28 mm
Clamp	25 mm <sup>2</sup>

## DEHNguard® modular (Y)PV SCI ...

- Prewired modular complete unit for use in photovoltaic systems consisting of a base part and plug-in protection modules
- Combined disconnection and short-circuiting device with safe electrical isolation in the protection module prevents fire damage resulting from d.c. switching arcs (patented SCI principle)
- Tried and tested fault-resistant Y circuit of DEHNguard M YPV SCI ... (FM) prevents damage to surge protective devices in case of insulation faults in the generator circuit
- Integrated d.c. fuse allows safe replacement of protection modules without arc formation
- Tested to EN 50539-11
- Suitable for use in all PV systems according to IEC 60364-7-712



For protecting low-voltage consumer's installations against surges. For use in accordance with IEC 60364-7-712 (installation of photovoltaic power supply systems).

DEHNguard M YPV SCI 150:	Modular multipole surge arrester with three-step d.c. switching device; for photovoltaic systems up to 150 V
DEHNguard M YPV SCI 600:	For photovoltaic systems up to 600 V
DEHNguard M YPV SCI 1000:	For photovoltaic systems up to 1000 V
DEHNguard M PV2 SCI 1000:	For photovoltaic systems up to 1000 V; for protecting two MPP inputs
DEHNguard M YPV SCI 1200:	For photovoltaic systems up to 1200 V
DEHNguard M YPV SCI ... FM:	With remote signalling contact for monitoring device (floating changeover contact)
DEHNguard S PV SCI 150:	For photovoltaic systems up to 150 V solidly earthed on the d.c. side
DEHNguard S PV SCI 600:	For photovoltaic systems up to 600 V solidly earthed on the d.c. side
DEHNguard S PV SCI ... FM:	With remote signalling contact for monitoring device (floating changeover contact)

The modular DEHNguard modular (Y)PV SCI ... (FM) surge arresters are specifically designed for protecting equipment in photovoltaic systems. The patented three-step d.c. switching device (SCI principle) makes these arresters especially safe so that they fulfil the requirements in modern photovoltaic systems. The devices are available for 150 V, 600 V, 1000 V and 1200 V applications. DEHNguard ME YPV SCI 1500 (FM) – a 1500 V version – covers the most common voltage levels. DEHNguard M PV2 SCI ... also provides protection for 2 MPP inputs in a single device.

The application features of the modular Red/Line family design are similarly unique as the three-step d.c. switching device. The module locking system firmly fixes the protection modules to the base part. Neither shock nor vibration nor the enormous forces of discharge affect the safe connection to the protection module. Nevertheless, the protection modules can be easily replaced without tools by simply pressing the easy-to-use module release button of the protection modules. Every protective path of DEHNguard modular (Y)PV SCI ... (FM) and every protection module is mechanically coded to ensure against installing the incorrect module.

To fulfil the special requirements in photovoltaic systems, a fault-resistant Y circuit consisting of three protective paths of the varistor and a combined disconnection and short-circuiting device are integrated in a single device.

This synergy reduces the probability of an arrester failure in case of the operating and fault states which have to be considered in photovoltaic systems. This ensures that the arrester is protected in case of overload, thus eliminating a fire risk to the system. Even in case of voltages up to 1200 V d.c., a switching arc, which is likely to occur in the surge protective device if a conventional disconnector (for a.c. application) is activated, is extinguished immediately without risk. Fire protection is the top priority of these surge arresters.

A fuse particularly developed for photovoltaic systems is integrated in the short-circuit path. This ensures safe electrical isolation in case of a faulty protection module, allowing de-energised replacement of the protection

module without arc formation. This unique design combines surge protection, fire protection and personal protection. Due to this innovative and unique design, DEHNguard modular (Y)PV SCI ... (FM) can be used in all low, medium and high-performance photovoltaic systems with no need for an additional backup fuse.

DG S PV SCI ... (FM) arresters are specifically designed for PV systems solidly earthed on the d.c. side. Since either the positive or the negative pole of the PV generator is solidly earthed, the space-saving and thus cost-effective DG S PV SCI ... (FM) arresters can be used where one protection module has been removed from the Y circuit.

The green and red indicator flags show the availability of every protective circuit. Apart from this visual indication, DEHNguard (Y)PV SCI ... (FM) arresters also feature a three-pole remote signalling terminal. With its floating changeover contact, the remote signal can be used as make or break contact according to the particular circuit concept. As with all surge arresters of the modular DEHNguard modular family, DEHNguard modular (Y)PV SCI ... (FM) arresters incorporate multifunctional terminals on a standardised spacing of 1 module for connecting conductors and busbars, allowing easy wiring with other DIN rail mounted devices.

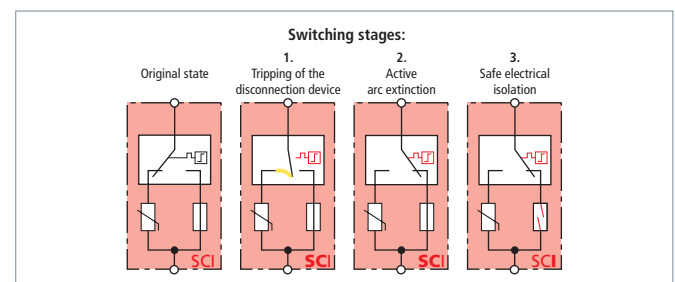

Three-step d.c. switching device (patented SCI principle)

**DEHNGuard M YPV SCI ...**

Modular multipole surge arrester with three-step d.c. switching device for use in PV systems.



Type DG M YPV ...	SCI 150	SCI 600	SCI 1000	SCI 1200
Part No.	952 513	952 511	952 510	952 512
SPD according to EN 50539-11	type 2	type 2	type 2	type 2
Max. PV voltage ( $U_{CPV}$ )	150 V	600 V	1000 V	1200 V
Short-circuit current rating ( $I_{SCPV}$ )	10 kA	10 kA	10 kA	10 kA
Nominal discharge current (8/20 $\mu$ s) [(DC+/DC-) --> PE] ( $I_n$ )	10 kA	12.5 kA	12.5 kA	12.5 kA
Max. discharge current (8/20 $\mu$ s) [(DC+/DC-) --> PE] ( $I_{max}$ )	20 kA	25 kA	25 kA	25 kA
Voltage protection level ( $U_p$ )	$\leq 0.8$ kV	$\leq 2.5$ kV	$\leq 4$ kV	$\leq 4.5$ kV
Approvals	KEMA, UL, CSA	KEMA, UL, CSA	KEMA, UL, CSA	KEMA, UL, CSA

**DEHNGuard M YPV SCI ... FM**

Modular multipole surge arrester with three-step d.c. switching device for use in PV systems; with remote signalling contact for monitoring device (floating changeover contact).



Type DG M YPV ...	SCI 150 FM	SCI 600 FM	SCI 1000 FM	SCI 1200 FM
Part No.	952 518	952 516	952 515	952 517
SPD according to EN 50539-11	type 2	type 2	type 2	type 2
Max. PV voltage ( $U_{CPV}$ )	150 V	600 V	1000 V	1200 V
Short-circuit current rating ( $I_{SCPV}$ )	10 kA	10 kA	10 kA	10 kA
Nominal discharge current (8/20 $\mu$ s) [(DC+/DC-) --> PE] ( $I_n$ )	10 kA	12.5 kA	12.5 kA	12.5 kA
Max. discharge current (8/20 $\mu$ s) [(DC+/DC-) --> PE] ( $I_{max}$ )	20 kA	25 kA	25 kA	25 kA
Voltage protection level ( $U_p$ )	$\leq 0.8$ kV	$\leq 2.5$ kV	$\leq 4$ kV	$\leq 4.5$ kV
Approvals	KEMA, UL, CSA	KEMA, UL, CSA	KEMA, UL, CSA	KEMA, UL, CSA
Type of remote signalling contact	changeover contact	changeover contact	changeover contact	changeover contact

**DEHNGuard S PV SCI ...**

Modular single-pole surge arrester with three-step d.c. switching device for PV systems earthed on the d.c. side.



Type DG S PV ...	SCI 150	SCI 600
Part No.	952 551	952 550
SPD according to EN 50539-11	type 2	type 2
Max. PV voltage ( $U_{CPV}$ )	150 V	600 V
Short-circuit current rating ( $I_{SCPV}$ )	10 kA	10 kA
Nominal discharge current (8/20 $\mu$ s) [(DC+/DC-) --> PE] ( $I_n$ )	10 kA	12.5 kA
Max. discharge current (8/20 $\mu$ s) [(DC+/DC-) --> PE] ( $I_{max}$ )	20 kA	25 kA
Voltage protection level ( $U_p$ )	$\leq 0.8$ kV	$\leq 2.5$ kV
Approvals	KEMA, UL, CSA	KEMA, UL, CSA

**DEHNGuard S PV SCI ... FM**

Modular single-pole surge arrester with three-step d.c. switching device for PV systems earthed on the d.c. side; with remote signalling contact for monitoring device (floating changeover contact).



Type DG S PV ...	SCI 150 FM	SCI 600 FM
Part No.	952 556	952 555
SPD according to EN 50539-11	type 2	type 2
Max. PV voltage ( $U_{CPV}$ )	150 V	600 V
Short-circuit current rating ( $I_{SCPV}$ )	10 kA	10 kA
Nominal discharge current (8/20 $\mu$ s) [(DC+/DC-) --> PE] ( $I_n$ )	10 kA	12.5 kA
Max. discharge current (8/20 $\mu$ s) [(DC+/DC-) --> PE] ( $I_{max}$ )	20 kA	25 kA
Voltage protection level ( $U_p$ )	$\leq 0.8$ kV	$\leq 2.5$ kV
Approvals	KEMA, UL, CSA	KEMA, UL, CSA
Type of remote signalling contact	changeover contact	changeover contact



## Surge Arresters – Type 2 for PV Systems

### DEHNguard M PV2 SCI ... (FM)

Modular multipole surge arrester with three-step d.c. switching device for protecting two MPP inputs; for use in PV systems up to 1000 V; FM version with floating remote signalling contact.

Type DG M PV2 ...	SCI 1000	SCI 1000 FM
Part No.	952 514	952 519
SPD according to EN 50539-11	type 2	type 2
Max. PV voltage ( $U_{CPV}$ )	1000 V	1000 V
Short-circuit current rating ( $I_{SCP}$ )	10 kA	10 kA
Nominal discharge current (8/20 $\mu$ s) [(DC+/DC-) --> PE] ( $I_n$ )	12.5 kA	12.5 kA
Max. discharge current (8/20 $\mu$ s) [(DC+/DC-) --> PE] ( $I_{max}$ )	25 kA	25 kA
Voltage protection level ( $U_P$ )	$\leq 4$ kV	$\leq 4$ kV
Approvals	UL, KEMA	UL, KEMA
Type of remote signalling contact	—	changeover contact



### Accessories for DEHNguard® modular (Y)PV SCI ...

#### Varistor-Based Protection Module for DEHNguard M (S) (Y)PV SCI

Protection module with integrated back-up fuse for DEHNguard M (Y)PV SCI ... arresters comprising a varistor connected in parallel with a short-circuiting device.

Type DG MOD PV ...	SCI 75	SCI 300	SCI 500	SCI 600
Part No.	952 055	952 053	952 051	952 054
Max. continuous operating voltage (d.c.) ( $U_C$ )	75 V	300 V	500 V	600 V



#### Varistor-Based Protection Module for DEHNguard M (S) (Y)PV SCI

Varistor-based protection module for DEHNguard M YPV SCI ... and DEHNguard S PV SCI ... arresters.

Type DG MOD PV ...	75	300	500	600
Part No.	952 045	952 043	952 041	952 044
Max. continuous operating voltage (d.c.) ( $U_C$ )	75 V	300 V	500 V	600 V



## DEHNgard® modular E (Y)PV SCI 1500



For protecting low-voltage consumer's installations against surges. For use in accordance with IEC 60364-7-712 (installation of photovoltaic power supply systems).

- DEHNgard ME YPV SCI 1500:** Modular multipole surge arrester with three-step d.c. switching device for PV systems up to 1500 V
- DEHNgard SE PV SCI 1500:** For PV systems up to 1500 V solidly earthed on the d.c. side
- DEHNgard ME/SE (Y)PV SCI 1500 FM:** With remote signalling contact for monitoring device (floating changeover contact)

The modular DEHNgard ME YPV SCI 1500 (FM) and DEHNgard SE PV SCI 1500 (FM) surge arresters are specifically designed for protecting equipment in photovoltaic systems up to 1500 V. The new design of these arresters of the DEHNgard ... SCI family meets the increased requirements regarding such a high voltage range; this is reflected in the increased width (1.5 modules), additional terminal covers and a special terminal slot. The patented three-step d.c. switching device (SCI principle) makes these arresters particularly safe so that they fulfil all requirements in modern photovoltaic systems. The devices are specifically designed for PV systems with high system voltages (up to 1500 V). As with DEHNgard modular (Y)PV SCI ... (FM) arresters, which are available as 150 V, 600 V, 1000 V and 1200 V versions, they cover the most common voltage levels.

The application features of the modular Red/Line family design are similarly unique as the three-step d.c. switching device. The module locking system firmly fixes the protection modules to the base part. Neither shock nor vibration nor the enormous forces of discharge affect the safe connection to the protection module. Nevertheless, the protection modules can be easily replaced without tools by simply pressing the easy-to-use module release button of the protection modules. Every protective path of DEHNgard modular E (Y)PV SCI 1500 (FM) and every protection module is mechanically coded to ensure against installing the incorrect module.

To fulfil the special requirements in photovoltaic systems, a fault-resistant Y circuit consisting of three protective paths of the varistor and a combined disconnection and short-circuiting device are integrated in a single device.

This synergy further reduces the probability of an arrester failure in case of the operating and fault states which have to be considered in photovoltaic systems. This ensures that the arrester is protected in case of overload without presenting a risk of fire to the system. Even in case of voltages up to 1500 V d.c., a switching arc, which is likely to occur when a conventional disconnector (for a.c. application) of a surge protective device is triggered, is extinguished immediately without risk. Fire protection is the top priority of DEHNgard ME YPV SCI 1500 (FM) and DEHNgard SE PV SCI 1500 (FM) surge arresters.

- Prewired modular complete unit for use in photovoltaic systems up to 1500 V consisting of a base part and plug-in protection modules
- Combined disconnection and short-circuiting device with safe electrical isolation in the protection module prevents fire damage resulting from d.c. switching arcs (patented SCI principle)
- Integrated d.c. fuse allows safe replacement of protection modules without arc formation
- New design for safe use in PV systems up to 1500 V
- Tested to EN 50539-11
- Suitable for use in all PV systems in accordance with IEC 60364-7-712

A special fuse integrated in the short-circuit path allows de-energised replacement of the protection module without arc formation. This unique design combines surge, fire and personal protection. Due to this innovative and unique design, the arresters can be used in all low, medium and high-performance photovoltaic systems with no need for an additional backup fuse.

**DEHNgard SE PV SCI 1500 (FM)** arresters are specifically designed for systems solidly earthed on the d.c. side; this type of earthing is meanwhile required e.g. by manufacturers of special thin-film modules or for legal or normative reasons in some regions.

Since either the positive or the negative pole of the PV generator is solidly earthed, the optimised DEHNgard SE PV SCI 1500 (FM) arresters (one protection module is removed from the Y circuit) may be used if the distance from the earthing point does not exceed 5 m.

The green and red indicator flags show the availability of every protective circuit. Apart from this visual indication, DEHNgard ME YPV SCI 1500 FM und DEHNgard SE PV SCI 1500 FM arresters also feature a three-pole remote signalling terminal. With its floating changeover contact, the remote signal can be used as make or break contact according to the particular circuit concept.

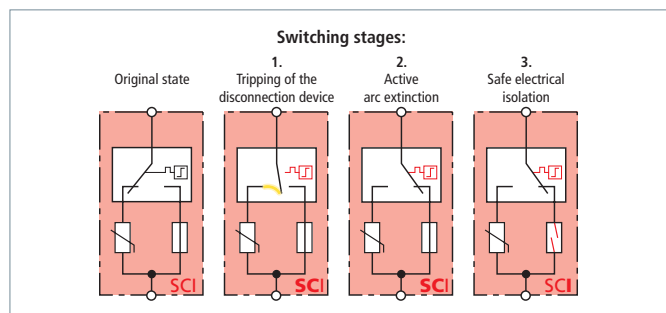

Three-step d.c. switching device (patented SCI principle)

## Surge Arresters – Type 2 for PV Systems

### DEHNguard ME YPV SCI 1500 (FM)

Modular multipole surge arrester with three-step d.c. switching device for PV systems.

Type DG ...	ME YPV SCI 1500	ME YPV SCI1500 FM
Part No.	952 520	952 525
SPD according to EN 50539-11	type 2	type 2
Max. PV voltage ( $U_{CPV}$ )	1500 V	1500 V
Short-circuit current rating ( $I_{SCP}$ )	10 kA	10 kA
Total discharge current (8/20 $\mu$ s) ( $I_{total}$ )	25 kA	25 kA
Nominal discharge current (8/20 $\mu$ s) [(DC+/DC-) --> PE] ( $I_n$ )	12.5 kA	12.5 kA
Voltage protection level ( $U_P$ )	$\leq 6$ kV	$\leq 6$ kV
Approvals	KEMA, UL	KEMA, UL
Type of remote signalling contact	—	changeover contact



### DEHNguard SE PV SCI 1500 (FM)

Modular single-pole surge arrester with three-step d.c. switching device for PV systems earthed on the d.c. side; FM version with floating remote signalling contact.

Type DG ...	SE PV SCI 1500	SE PV SCI 1500 FM
Part No.	952 561	952 566
SPD according to EN 50539-11	type 2	type 2
Max. PV voltage ( $U_{CPV}$ )	1500 V	1500 V
Short-circuit current rating ( $I_{SCP}$ )	10 kA	10 kA
Nominal discharge current (8/20 $\mu$ s) [(DC+/DC-) --> PE] ( $I_n$ )	12.5 kA	12.5 kA
Voltage protection level ( $U_P$ )	$\leq 6$ kV	$\leq 6$ kV
Approvals	KEMA, UL	KEMA, UL
Type of remote signalling contact	—	changeover contact



## Accessories for DEHNguard® modular E (Y)PV SCI 1500

### Varistor-Based Protection Module for DEHNguard ME YPV SCI and DEHNguard SE PV SCI

Varistor-based protection module for DEHNguard ME YPV SCI 1500 (FM) and DEHNguard SE PV SCI 1500 (FM)

Type	DG MOD E PV SCI 750
Part No.	952 056
Max. continuous operating voltage (d.c.) ( $U_c$ )	750 V



## DEHNguard® YPV SCI ... – compact



For protecting low-voltage consumer's installations against surges. For use in accordance with IEC 60364-7-712 (installation of photovoltaic power supply systems).

- Prewired complete unit for use in photovoltaic systems
- Combined disconnection and short-circuiting device with safe electrical isolation prevents fire damage resulting from d.c. switching arcs (patented SCI principle)
- Tried and tested fault-resistant Y circuit of DEHNguard YPV SCI ... prevents damage to surge protective devices in case of insulation faults in the generator circuit
- Tested to EN 50539-11
- Suitable for use in all PV systems according to IEC 60364-7-712

**DEHNguard YPV SCI 600/1000:** Multipole surge arrester with three-step d.c. switching device; for photovoltaic systems up to 600/1000 V  
**DEHNguard YPV SCI ... FM:** With remote signalling contact for monitoring device (floating changeover contact)

The DEHNguard YPV SCI ... surge arresters are specifically designed for protecting equipment in photovoltaic systems. The patented three-step d.c. switching device (SCI principle) makes these arresters particularly safe so that they fulfil all requirements in modern photovoltaic systems. The devices are available as 600 V and 1000 V versions and cover the most common voltage levels for string inverter systems.

To fulfil the special requirements in photovoltaic systems, a fault-resistant Y circuit consisting of three protective paths of the varistor and a combined disconnection and short-circuiting device are integrated in a single device.

This synergy further reduces the probability of an arrester failure in case of the operating and fault states which have to be considered in photovoltaic systems. This ensures that the arrester is protected in case of overload, thus eliminating a fire risk to the system. Even in case of voltages up to 1000 V d.c., a switching arc, which is likely to occur when a conventional disconnector (for a.c. application) of a surge protective device is triggered, is extinguished immediately without risk. Fire protection is the top priority of DEHNguard YPV SCI ... surge arresters.

A fuse particularly developed for photovoltaic systems is integrated in the short-circuit path. This ensures safe electrical isolation in case of a faulty surge protective device. This unique design combines surge, fire and personal protection. Due to this innovative and unique design, DEHNguard YPV SCI ... can be used in all low and medium-performance photovoltaic systems with no need for an additional backup fuse.

DEHNguard YPV SCI ... is a special cost-effective and application-optimised device which is particularly designed for sting inverter systems with a limited system current up to 1000 A. The design includes the main device features without compromising safety.

The green and red indicator flags show the availability of every protective circuit. Apart from this visual indication, DEHNguard YPV SCI ... (FM) arresters also feature a three-pole remote signalling terminal. With its floating changeover contact, the remote signal can be used as make or break contact according to the particular circuit concept.

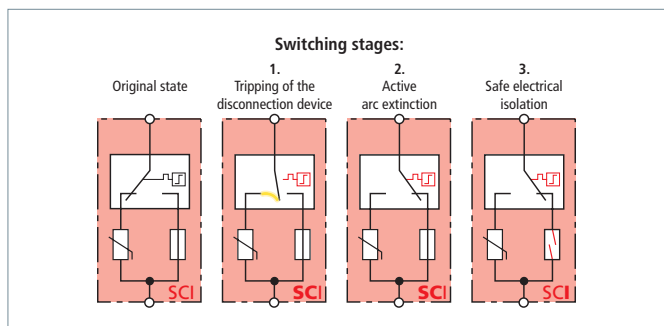

Three-step d.c. switching device (patented SCI principle)

### DEHNgard compact YPV SCI ...

Multipole surge arrester with three-step d.c. switching device for use in PV systems.

Type DG YPV SCI ...	600	1000
Part No.	950 531	950 530
SPD according to EN 50539-11	type 2	type 2
Max. PV voltage ( $U_{CPV}$ )	600 V	1000 V
Short-circuit current rating ( $I_{SCPV}$ )	1000 A	1000 A
Nominal discharge current (8/20 $\mu$ s) [(DC+/DC-) --> PE] ( $I_n$ )	12.5 kA	12.5 kA
Max. discharge current (8/20 $\mu$ s) [(DC+/DC-) --> PE] ( $I_{max}$ )	25 kA	25 kA
Voltage protection level ( $U_p$ )	$\leq 2.5$ kV	$\leq 4$ kV
Approvals	KEMA, UL	KEMA, UL



### DEHNgard compact YPV SCI ... FM

Multipole surge arrester with three-step d.c. switching device for use in PV systems, with remote signalling contact for the monitoring device (floating changeover contact).

Type DG YPV SCI ...	600 FM	1000 FM
Part No.	950 536	950 535
SPD according to EN 50539-11	type 2	type 2
Max. PV voltage ( $U_{CPV}$ )	600 V	1000 V
Short-circuit current rating ( $I_{SCPV}$ )	1000 A	1000 A
Nominal discharge current (8/20 $\mu$ s) [(DC+/DC-) --> PE] ( $I_n$ )	12.5 kA	12.5 kA
Max. discharge current (8/20 $\mu$ s) [(DC+/DC-) --> PE] ( $I_{max}$ )	25 kA	25 kA
Voltage protection level ( $U_p$ )	$\leq 2.5$ kV	$\leq 4$ kV
Approvals	KEMA, UL	KEMA, UL
Type of remote signalling contact	changeover contact	changeover contact



## DEHNcube



For protecting low-voltage consumer's installations against surges. For use in accordance with IEC 60364-7-712 (installation of photovoltaic power supply systems).

- Prewired multipole surge arrester with IP 65 degree of protection for use in photovoltaic systems
- No space required in a distribution board enclosure
- Prewired connection cables (accessory) make it easier to connect the surge arrester directly upstream of the inverter to be protected
- Combined disconnection and short-circuiting device with safe electrical isolation in every protective path avoids fire damage caused by d.c. switching arcs (patented SCI principle)
- Spring-loaded terminals for easy and quick connection without tools
- Tested to EN 50539-11
- For use in all PV systems according to IEC 60364-7-712

**DEHNcube YPV SCI 1000 1M:** Two-pole surge arrester with IP 65 degree of protection and three-step d.c. switching device for protecting one MPP input; for PV systems up to 1000 V

**DEHNcube YPV SCI 1000 2M:** Four-pole surge arrester with IP 65 degree of protection and three-step d.c. switching device for protecting two MPP inputs; for PV systems up to 1000 V

The robust and flexible surge arresters of the DEHNcube YPV SCI 1000 ... family are specifically developed for protecting equipment in photovoltaic systems. The patented three-step d.c. switching device (SCI principle) makes these devices particularly safe so that they fulfil all requirements in modern photovoltaic systems.

DEHNcube YPV SCI 1000 ... is the first surge arrester with IP 65 degree of protection from DEHN + SÖHNE that is tested to EN 50539-11. Thus, no space is required in a distribution board enclosure or a distribution board enclosure does not have to be installed just for the surge protective device as is the case with standard DIN rail mounted arresters. DEHNcube YPV SCI 1000 ... may be installed right next to the inverter, i.e. it is ideally suited for quickly and easily retrofitting a surge protective device in an existing PV system. The optionally available prewired X or Y connecting cables ensure easy connection of DEHNcube YPV SCI 1000 ... These connecting cables are as short as possible to ensure maximum protection, but at the same time long enough to ensure user-friendly, easy and feasible cabling.

To fulfil the special requirements in PV systems, the approved fault-resistant Y circuit consisting of three protective paths of the varistor and a combined disconnection and short-circuiting device are integrated in a single device.

This synergy further reduces the probability of an arrester failure in case of the operating and fault states which have to be considered in PV systems. This ensures that the arrester is protected in case of overload, thus eliminating a fire risk to the system. Even in case of voltages up to 1000 V

d.c., a switching arc, which is likely to occur when a conventional disconnector of a surge protective device is triggered, is extinguished immediately without risk. Fire protection is the top priority of DEHNcube YPV SCI 1000 ... This is ensured by its approved fault-resistant Y circuit which prevents damage to the surge protective devices in case of insulation faults in the generator circuit.

To ensure safe electrical isolation in case of a faulty surge protective device, a fuse which was particularly developed for PV systems was integrated into the short-circuit path. This unique design combines surge, fire and personal protection. Due to this innovative and unique design, DEHNcube YPV SCI 1000 ... can be used in all low, medium and high-performance photovoltaic systems with no need for an additional backup fuse.

DEHNcube YPV SCI 1000 ... is a special type 2 surge protective device, which may be quickly installed directly next to the equipment of the PV generator circuit it is supposed to protect without requiring an additional insulating enclosure. The IP 65 degree of protection ensures that it is dust-proof and jet-water-tight. A pressure compensating element with an air-permeable and water-tight special grommet which avoids condensation in the enclosure is imperative for safe outdoor use and is therefore already integrated as a standard.

Wiring is quite easy with the X and Y connecting cables which are available as accessory. Various application possibilities of the connecting cables are illustrated on the following pages.

### DEHNcube YPV SCI 1000 1M

Three-pole surge arrester with IP 65 degree of protection and three-step d.c. switching device for PV inverters for protecting one MPP input.

Type DCU YPV SCI 1000 ...	<b>1M</b>
Part No.	<b>900 910</b>
SPD according to EN 50539-11	type 2
Max. PV voltage ( $U_{CPV}$ )	1000 V
Short-circuit withstand capability ( $I_{SCPV}$ )	1000 A
Nominal discharge current (8/20 $\mu$ s) [(DC+/DC-) --> PE] ( $I_n$ )	12.5 kA
Max. discharge current (8/20 $\mu$ s) [(DC+/DC-) --> PE] ( $I_{max}$ )	25 kA
Voltage protection level ( $U_P$ )	$\leq 4$ kV
Degree of protection	IP 65



### DEHNcube YPV SCI 1000 2M

Five-pole surge arrester with IP 65 degree of protection and three-step d.c. switching device for PV inverters for protecting two MPP inputs.

Type DCU YPV SCI 1000 ...	<b>2M</b>
Part No.	<b>900 920</b>
SPD according to EN 50539-11	type 2
Max. PV voltage ( $U_{CPV}$ )	1000 V
Short-circuit withstand capability ( $I_{SCPV}$ )	1000 A
Nominal discharge current (8/20 $\mu$ s) [(DC+/DC-) --> PE] ( $I_n$ )	12.5 kA
Max. discharge current (8/20 $\mu$ s) [(DC+/DC-) --> PE] ( $I_{max}$ )	25 kA
Voltage protection level ( $U_P$ )	$\leq 4$ kV
Degree of protection	IP 65



AL DCU X / AL DCU Y



Prewired connecting cables for easily connecting the incoming string lines to DEHNcube and the inverter.

- PV connecting cables for easily connecting DEHNcube YPV SCI 1000 ... to the inverter
- Suitable for outdoor use
- 6 mm<sup>2</sup> for minimum voltage drop
- Dimensions tailored to the relevant application
- Cable ends already stripped for quick connection to DEHNcube YPV SCI 1000 ... and the PV connector
- Four different versions to cover all applications

- AL DCU Y ...: For connecting one string to DEHNcube and the inverter
- AL DCU X ...: For collecting two strings and connecting them to DEHNcube and the inverter
- AL DCU ... L600: 600 mm connecting cable from the node to the d.c. input of the inverter
- AL DCU ... L1000: 1000 mm connecting cable from the node to the d.c. input of the inverter

The connecting cables AL DCU X PV and AL DCU Y PV from DEHN + SÖHNE enable an easy and quick connection of DEHNcube YPV SCI 1000 1M and DEHNcube YPV SCI 1000 2M surge arresters.

The AL DCU Y PV connecting cable can be used to connect one string to the inverter input to protect it from surges. This cable features three ends for the connections of the inverter (1), DEHNcube (2) and one string line (3). The designation Y symbolises the three cable ends.

The AL DCU X PV connecting cable can be used to collect two strings and to connect them to an inverter input to protect it from surges. This cable features four cable ends for the connections of the inverter (1), DEHNcube (2), the first string line (3) and the second string line (4). The designation X symbolises the four cable ends.

Two versions of AL DCU Y PV and AL DCU X PV with different cable lengths (1) (600 mm or 1000 mm) are available since the distance between the position of DEHNcube and the d.c. inputs of the inverter depends on the manufacturer and may vary according to the environmental conditions at the place of installation.

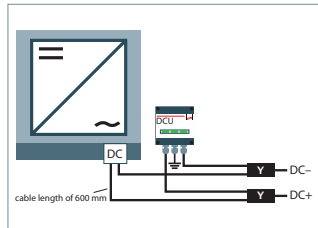

L600 version

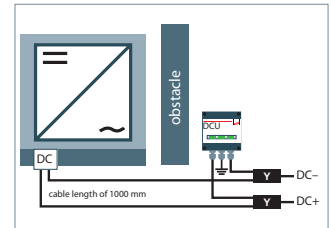

L1000 version



Application: Two strings per d.c. input (MPP tracker) of the inverter.



Application: One string per d.c. input (MPP tracker) of the inverter.

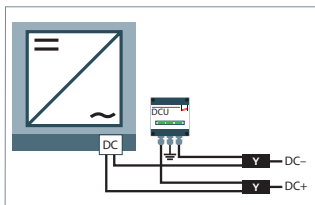

Two AL DCU Y PV connecting cables connected to DEHNcube and the inverter.

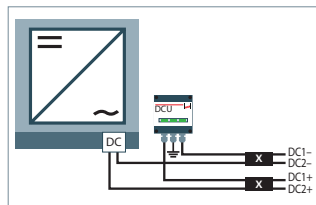

Two AL DCU X PV connecting cables collect two strings and connect them to DEHNcube and the inverter.

Connection to the inverter, string line (module side) and DEHNcube: The cable ends are already stripped to 15 mm to ensure quick attachment of the required PV connector (supplied with the inverter). The connection (2) is stripped by 12 mm since this is the required stripping length of the spring-loaded terminals of DEHNcube.



The cables are long enough for the required distances, but as short as possible to ensure maximum protection and to keep transmission loss as low as possible. The connecting cables have a cross-section of 6 mm<sup>2</sup> which means that transmission loss is reduced to a minimum. Due to their design, they are suitable for outdoor use in photovoltaic systems.

The applications shown can also be used for inverters with two MPP inputs which are protected by DCU YPV SCI 1000 2M.

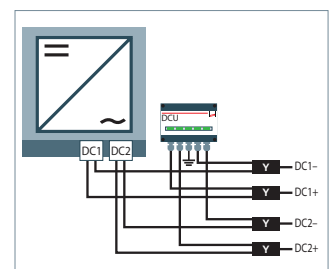

Example: DCU YPV SCI 1000 2M.



### X Connecting Cable for DEHNCube

X connecting cable for DEHNCube allows to collect two PV strings and connect them to DEHNCube and the inverter.

Type AL DCU ...	X PV L600	X PV L1000
Part No.	900 946	900 947
For connecting	2 strings	2 strings
Cable cross-section	6 mm <sup>2</sup>	6 mm <sup>2</sup>
Cable material	<b>Cu</b>	<b>Cu</b>
Degree of protection	IP 65	IP 65
Length	600 mm	1000 mm



### Y Connecting Cable for DEHNCube

Y connecting cable for DEHNCube allows to collect one PV string and connect it to DEHNCube and the inverter.

Type AL DCU ...	Y PV L600	Y PV L1000
Part No.	900 948	900 949
For connecting	1 string	1 string
Cable cross-section	6 mm <sup>2</sup>	6 mm <sup>2</sup>
Cable material	<b>Cu</b>	<b>Cu</b>
Degree of protection	IP 65	IP 65
Length	600 mm	1000 mm





## DEHNGuard® PCB

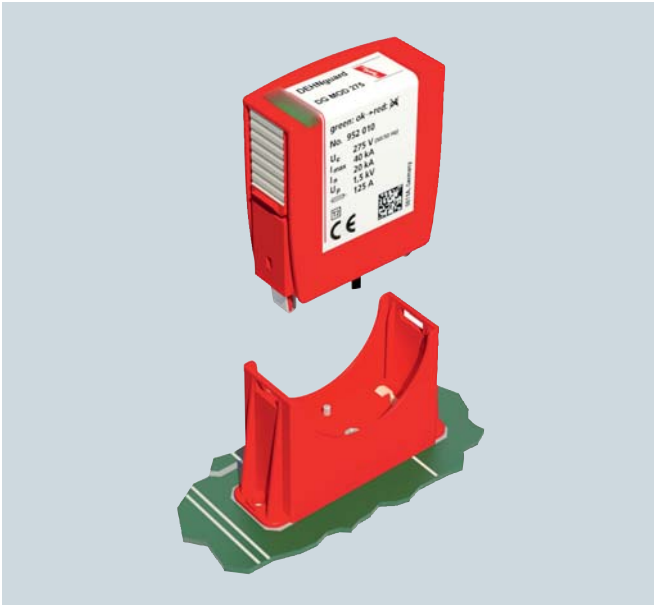

For integrating a type 2 arrester on the printed circuit board of a device to provide surge protection. For installation in conformity with the lightning protection zone concept at the boundaries from 0<sub>B</sub>-1 and higher.

- Base for DEHNGuard protection modules to be mounted on and integrated in PCBs
- Optimal integration of a type 2 arrester in devices
- Easy and flexible use for all circuit configurations
- Proven DEHNGuard modules ensure high performance
- Coded base and protection module ensure against installing an incorrect module
- Version with and without remote signalling contact for the monitoring device
- Versions meeting maximum requirements on air clearances and creepage distances
- Versions for other DEHNGuard protection modules on request

DEHNGuard PCB ...:	Base for mounting arresters on printed circuit boards
DEHNGuard PCB ... FM:	With remote signalling contact for monitoring device (floating changeover contact)
DEHNGuard PCB ... I ... FM:	With increased air clearances and creepage distances between the power and remote signalling contact

The single-pole DEHNGuard PCB ... (FM) base is specially designed for use on printed circuit boards (PCBs). Thus, surge protection can be taken into account at an early stage of development of the PCB and can be optimally integrated in the overall product. This single-pole version can be used for all system configurations. Fault-resistant Y circuits for PV systems or 3+1 circuits for a.c. systems can be easily implemented.

Thanks to the ideal positioning of the SPD on the device, an optimal voltage protection level is achieved for the electronics of the PCB since there is no cable length between the SPD and the device to be protected through which additional surges may be injected (in typical applications). The design of the PCB also allows series connection according to IEC 60364-5-53.

Various device features show that reliable surge protection and equipment reliability are a top priority of the modular DEHNGuard. The application-oriented product designation, which makes it considerably easier to assign the protection modules to the relevant DG PCB base part, and the unique module locking system reflect the high safety requirements. The module locking system firmly fixes the protection modules to DEHNGuard

PCB (FM). Neither vibration in the application environment nor the dynamic forces of discharge can loosen the protection modules. Nevertheless, they can be easily replaced without tools by simply pressing the easy-to-use module release button of the protection modules. Each DEHNGuard PCB (FM) base and each protection module is mechanically coded to ensure against installing an incorrect module.

The DG PCB ... I ... FM versions ensure increased distances between the power and remote signalling contact since special applications place increased requirements on air clearances and creepage distances between these circuits. Details can be found in the drilling scheme of the installation instructions which can be downloaded free of charge at [www.dehn-international.com](http://www.dehn-international.com).

The ...FM version of DG PCB... features a three-pole remote signalling contact. With its floating changeover contact, the remote signal can be used as a make or break contact according to the particular circuit concept.

### DEHNguard PCB PV SCI ...

Single-pole base for DEHNguard modules to be mounted on the PCBs of devices.

Type DG PCB ...	PV SCI 300	PV SCI 500	PV SCI 600
Part No.	952 653	952 651	952 654
Associated protection module	DG MOD PV SCI 300 (Part No. 952 053)	DG MOD PV SCI 500 (Part No. 952 051)	DG MOD PV SCI 600 (Part No. 952 054)
Max. continuous voltage (d.c.) (module)	300 V	500 V	600 V
Mounting	directly soldered into PCB	directly soldered into PCB	directly soldered into PCB
Degree of protection	IP 20 (protection module plugged in)	IP 20 (protection module plugged in)	IP 20 (protection module plugged in)



### DEHNguard PCB PV SCI ... FM

Single-pole base for DEHNguard modules to be mounted on the PCBs of devices, with remote signalling contact for the monitoring system (floating changeover contact).

Type DG PCB ...	PV SCI 300 FM	PV SCI 500 FM	PV SCI 600 FM
Part No.	952 753	952 751	952 754
Associated protection module	DG MOD PV SCI 300 (Part No. 952 053)	DG MOD PV SCI 500 (Part No. 952 051)	DG MOD PV SCI 600 (Part No. 952 054)
Max. continuous voltage (d.c.) (module)	300 V	500 V	600 V
Mounting	directly soldered into PCB	directly soldered into PCB	directly soldered into PCB
Degree of protection	IP 20 (protection module plugged in)	IP 20 (protection module plugged in)	IP 20 (protection module plugged in)
Type of remote signalling contact	changeover contact	changeover contact	changeover contact



### DEHNguard PCB PV ...

Single-pole base for DEHNguard modules to be mounted on the PCBs of devices.

Type DG PCB ...	PV 300	PV 500	PV 600
Part No.	952 643	952 641	952 644
Associated protection module	DG MOD PV 300 (Part No. 952 043)	DG MOD PV 500 (Part No. 952 041)	DG MOD PV 600 (Part No. 952 044)
Max. continuous voltage (d.c.) (module)	300 V	500 V	600 V
Mounting	directly soldered into PCB	directly soldered into PCB	directly soldered into PCB
Degree of protection	IP 20 (protection module plugged in)	IP 20 (protection module plugged in)	IP 20 (protection module plugged in)



### DEHNguard PCB PV ... FM

Single-pole base for DEHNguard modules to be mounted on the PCBs of devices, with remote signalling contact for the monitoring system (floating changeover contact).

Type DG PCB ...	PV 300 FM	PV 500 FM	PV 600 FM
Part No.	952 743	952 741	952 744
Associated protection module	DG MOD PV 300 (Part No. 952 043)	DG MOD PV 500 (Part No. 952 041)	DG MOD PV 600 (Part No. 952 044)
Max. continuous voltage (d.c.) (module)	300 V	500 V	600 V
Mounting	directly soldered into PCB	directly soldered into PCB	directly soldered into PCB
Degree of protection	IP 20 (protection module plugged in)	IP 20 (protection module plugged in)	IP 20 (protection module plugged in)
Type of remote signalling contact	changeover contact	changeover contact	changeover contact



### DEHNguard PCB ...

Single-pole base for DEHNguard modules to be mounted on the PCBs of devices.

Type DG PCB ...	275	385
Part No.	952 610	952 614
Associated protection module	DG MOD 275 (Part No. 952 010)	DG MOD 385 (Part No. 952 014)
Max. continuous voltage (a.c.) (module)	275 V	385 V
Mounting	directly soldered into PCB	directly soldered into PCB
Degree of protection	IP 20 (protection module plugged in)	IP 20 (protection module plugged in)



**DEHNgard PCB ... FM**

Single-pole base for DEHNgard modules to be mounted on the PCBs of devices, with remote signalling contact for the monitoring system (floating changeover contact).



Type DG PCB ...	275 FM	385 FM
Part No.	952 710	952 714
Associated protection module	DG MOD 275 (Part No. 952 010)	DG MOD 385 (Part No. 952 014)
Max. continuous voltage (a.c.) (module)	275 V	385 V
Mounting	directly soldered into PCB	directly soldered into PCB
Degree of protection	IP 20 (protection module plugged in)	IP 20 (protection module plugged in)
Type of remote signalling contact	changeover contact	changeover contact

**DEHNgard PCB NPE (FM)**

Single-pole base for DEHNgard modules to be mounted on the PCBs of devices, with remote signalling contact for the monitoring system (floating changeover contact).



Type DG PCB ...	NPE	NPE FM
Part No.	952 650	952 750
Associated protection module	DG MOD NPE (Part No. 952 050)	DG MOD NPE (Part No. 952 050)
Max. continuous voltage (a.c.) (module)	255 V	255 V
Mounting	directly soldered into PCB	directly soldered into PCB
Degree of protection	IP 20 (protection module plugged in)	IP 20 (protection module plugged in)
Type of remote signalling contact	—	changeover contact

**DEHNgard PCB PV I ... FM**

Single-pole base with increased air clearance and creepage distance between the power contacts and the remote signalling contact. For installation on the PCBs of devices to accommodate DEHNgard modules, with remote signalling contact for the monitoring system (floating changeover contact).



Type DG PCB ...	PV I 500 FM
Part No.	952 941
Associated protection module	DG MOD PV 500 (Part No. 952 041)
Max. continuous voltage (d.c.) (module)	500 V
Mounting	directly soldered into PCB
Degree of protection	IP 20 (protection module plugged in)
Type of remote signalling contact	changeover contact

**DEHNgard PCB PV SCI I ... FM**

Single-pole base with increased air clearance and creepage distance between the power contacts and the remote signalling contact. For installation on the PCBs of devices to accommodate DEHNgard modules, with remote signalling contact for the monitoring system (floating changeover contact).



Type DG PCB ...	PVSCI I 500FM
Part No.	952 951
Associated protection module	DG MOD PV SCI 500 (Part No. 952 051)
Max. continuous voltage (d.c.) (module)	500 V
Mounting	directly soldered into PCB
Degree of protection	IP 20 (protection module plugged in)
Type of remote signalling contact	changeover contact

**DEHNgard PCB I ... FM**

Single-pole base with increased air clearance and creepage distance between the power contacts and the remote signalling contact. For installation on the PCB's of devices to accommodate DEHNgard modules, with remote signalling contact for the monitoring system (floating changeover contact).

**NEW**



Type DG PCB ...	I 275 FM
Part No.	952 910 <sup>NEW</sup>
Associated protection module	DG MOD 275 (Part No. 952 010)
Max. continuous voltage (a.c.) (module)	275 V
Mounting	directly soldered into PCB
Degree of protection	IP 20 (protection module plugged in)
Type of remote signalling contact	changeover contact



## Protection Module for DEHNGuard® M, ... S and DEHNgap C S

- High discharge capacity due to heavy-duty zinc oxide varistors / spark gaps
- High reliability due to “Thermo Dynamic Control” SPD monitoring device
- Energy coordination with other arresters of the Red/Line product family
- Operating state / fault indication by green / red indicator flag in the inspection window
- Easy replacement of protection modules without tools due to module locking system with module release button
- The plug-in protection module can be replaced without the need to de-energise and without removing the distribution board cover
- Vibration and shock-tested according to EN 60068-2

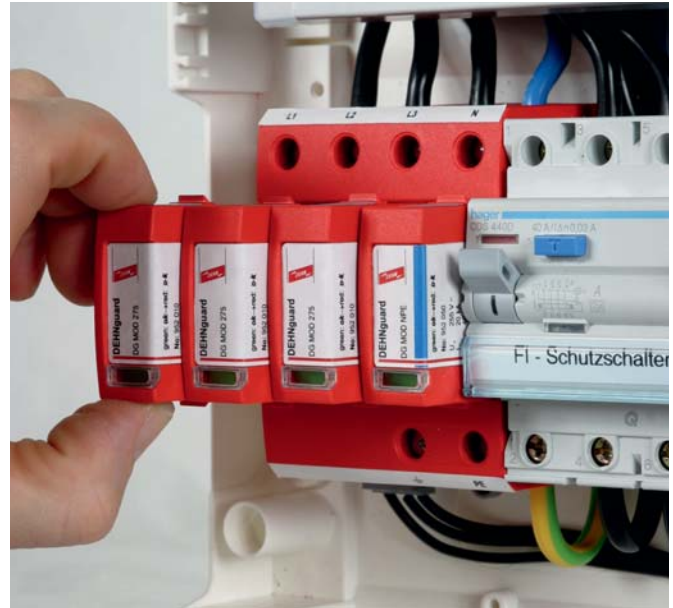

For protecting low-voltage consumer's installations against surges. For installation in conformity with the lightning protection zone concept at the boundaries from  $O_B - 1$  and higher.

DEHNGuard MOD CI 275:	Varistor-based protection module for DEHNGuard M CI ... surge arresters
DEHNGuard MOD ...:	Varistor-based protection module for DEHNGuard M ... and DEHNGuard S ... surge arresters
DEHNGuard MOD 750:	Varistor-based protection module for DEHNGuard M WE 600 and DEHNGuard S WE 600 surge arresters
DEHNGuard MOD NPE:	N-PE spark-gap-based protection module for two-pole and four-pole DEHNGuard M TT ... surge arresters
DEHNgap C MOD:	N-PE spark-gap-based protection module for single-pole N-PE surge arresters of type DEHNgap C S ...
DEHNGuard MOD ... VA:	Varistor-based and spark-gap-based protection module for DEHNGuard S ... VA surge arresters
DEHNGuard MOD PV SCI ...:	Varistor-based protection module for DEHNGuard M YPV SCI and DEHNGuard S PV SCI ... surge arresters
DEHNGuard MOD PV ...:	Varistor-based protection module for DEHNGuard M YPV SCI and DEHNGuard S PV SCI ... surge arresters
DEHNGuard MOD E PV SCI 750:	Varistor-based protection module for DEHNGuard ME YPV SCI and DEHNGuard SE PV SCI ... surge arresters
DEHNGuard MOD E H LI ...:	Varistor-based protection module for DEHNGuard SE H LI ... FM surge arresters
DEHNGuard MOD E H 1000:	Varistor-based protection module for DEHNGuard SE H 1000 FM surge arresters
DEHNGuard MOD E DC ...:	Varistor-based protection module for DEHNGuard SE DC ... surge arresters

The varistor and spark-gap-based protection modules of the DEHNGuard M, DEHNGuard S, DEHNGuard ME, DEHNGuard SE and DEHNgap C S devices distinguish themselves through their outstanding performance and appearance.

The compact protection modules incorporate the complete protective circuit as well as the monitoring and disconnection device.

The green indicator flag in the inspection window shows the operating state of the protection modules.

All protection modules are mechanically coded to ensure against installing an incorrect module.

The protection modules can be easily replaced without tools by simply pressing the easy-to-use module release button.



### Varistor-Based Protection Module for DEHNgard M CI

Protection module for DEHNgard M ... CI 275 surge arresters comprising a varistor connected in series with the integrated backup fuse.

Type	DG MOD CI 275
Part No.	952 020
Nominal discharge current (8/20 $\mu$ s) ( $I_n$ )	12.5 kA
Max. discharge current (8/20 $\mu$ s) ( $I_{max}$ )	25 kA
Max. continuous operating voltage (a.c.) ( $U_c$ )	275 V

### Varistor-based Protection Module

Varistor-based protection module for DEHNgard M ... and DEHNgard S ... surge arresters.

Type	DG MOD 48	DG MOD 75	DG MOD 150	DG MOD 275
Part No.	952 018	952 011	952 012	952 010
Nominal discharge current (8/20 $\mu$ s) ( $I_n$ )	7.5 kA	10 kA	15 kA	20 kA
Max. discharge current (8/20 $\mu$ s) ( $I_{max}$ )	25 kA	40 kA	40 kA	40 kA
Max. continuous operating voltage (a.c.) ( $U_c$ )	48 V	75 V	150 V	275 V



Type	DG MOD 320	DG MOD 385	DG MOD 440	DG MOD 600
Part No.	952 013	952 014	952 015	952 016
Nominal discharge current (8/20 $\mu$ s) ( $I_n$ )	20 kA	20 kA	20 kA	15 kA
Max. discharge current (8/20 $\mu$ s) ( $I_{max}$ )	40 kA	40 kA	40 kA	30 kA
Max. continuous operating voltage (a.c.) ( $U_c$ )	320 V	385 V	440 V	600 V

### Varistor-Based Protection Module for DEHNgard M (S) WE

Varistor-based protection module for DEHNgard M WE ... and DEHNgard S WE ... surge arresters with a rated varistor voltage  $U_{mov} = 750$  V a.c.

Type	DG MOD 750
Part No.	952 017
Nominal discharge current (8/20 $\mu$ s) ( $I_n$ )	15 kA
Max. discharge current (8/20 $\mu$ s) ( $I_{max}$ )	25 kA
Max. continuous operating voltage (a.c.) ( $U_c$ )	600 V
Rated varistor voltage ( $U_{mov}$ )	750 V



### N-PE Spark-Gap-Based Protection Module for DEHNgard M TT ...

N-PE spark-gap-based protection module for two-pole and four-pole DEHNgard DG M TT ... surge arresters.

Type	DG MOD NPE
Part No.	952 050
Nominal discharge current (8/20 $\mu$ s) ( $I_n$ )	20 kA
Max. discharge current (8/20 $\mu$ s) ( $I_{max}$ )	40 kA
Max. continuous operating voltage (a.c.) ( $U_c$ )	255 V



### N-PE Spark-Gap-Based Protection Module for DEHNgap C S

Protection module for single-pole N-PE surge arresters of type DEHNgap DGP C S ...

Type	DGP C MOD
Part No.	952 060
Nominal discharge current (8/20 $\mu$ s) ( $I_n$ )	20 kA
Max. discharge current (8/20 $\mu$ s) ( $I_{max}$ )	40 kA
Max. continuous operating voltage (a.c.) ( $U_c$ )	255 V



### Varistor and Spark-Gap-Based Protection Module for DEHNgard S ... VA

Protection module for DEHNgard S ... VA surge arresters comprising a varistor connected in series with a spark gap.

Type	DG MOD 75 VA	DG MOD 275 VA	DG MOD 385 VA
Part No.	952 025	952 027	952 029
Nominal discharge current (8/20 $\mu$ s) ( $I_n$ )	10 kA	10 kA	10 kA
Max. discharge current (8/20 $\mu$ s) ( $I_{max}$ )	20 kA	20 kA	20 kA
Max. continuous operating voltage (a.c.) ( $U_c$ )	75 V	275 V	385 V
Max. continuous operating voltage (d.c.) ( $U_c$ )	100 V	350 V	500 V



## Surge Arresters – Type 2

### Varistor-Based Protection Module for DEHNguard M YPV SCI and DEHNguard S PV SCI

Protection module for DEHNguard M (Y)PV SCI ... surge arresters.

Type DG MOD ...	PV SCI 75	PV SCI 300	PV SCI 500	PV SCI 600
Part No.	952 055	952 053	952 051	952 054
Nominal discharge current (8/20 $\mu$ s) ( $I_n$ )	10 kA	12.5 kA	12.5 kA	12.5 kA
Max. discharge current (8/20 $\mu$ s) ( $I_{max}$ )	20 kA	25 kA	25 kA	25 kA
Max. continuous operating voltage (d.c.) ( $U_c$ )	75 V	300 V	500 V	600 V



### Varistor-Based Protection Module for DEHNguard M YPV SCI and DEHNguard S PV SCI

Varistor-based protection module for DEHNguard M YPV SCI ... and DEHNguard S PV SCI ... surge arresters.

Type DG MOD ...	PV 75	PV 300	PV 500	PV 600
Part No.	952 045	952 043	952 041	952 044
Nominal discharge current (8/20 $\mu$ s) ( $I_n$ )	10 kA	20 kA	20 kA	15 kA
Max. discharge current (8/20 $\mu$ s) ( $I_{max}$ )	40 kA	40 kA	40 kA	30 kA
Max. continuous operating voltage (d.c.) ( $U_c$ )	75 V	300 V	500 V	600 V



### Varistor-Based Protection Module for DEHNguard ME YPV SCI and DEHNguard SE PV SCI

Varistor-based protection module for DEHNguard ME YPV SCI 1500 (FM) and DEHNguard SE PV SCI 1500 (FM) surge arresters.

Type DG MOD ...	E PV SCI 750
Part No.	952 056
Nominal discharge current (8/20 $\mu$ s) ( $I_n$ )	12.5 kA
Max. discharge current (8/20 $\mu$ s) ( $I_{max}$ )	25 kA
Max. continuous operating voltage (d.c.) ( $U_c$ )	750 V



### Varistor-Based Protection Module for DEHNguard SE H (LI) ...

Varistor-based protection module for DEHNguard SE H (LI) ... surge arresters.

Type DG MOD ...	E H LI 275	E H LI 320	E H LI 385
Part No.	952 900	952 903 <sup>NEW</sup>	952 904 <sup>NEW</sup>
Nominal discharge current (8/20 $\mu$ s) ( $I_n$ )	30 kA	30 kA	30 kA
Max. discharge current (8/20 $\mu$ s) ( $I_{max}$ )	65 kA	65 kA	65 kA
Max. continuous operating voltage (a.c.) ( $U_c$ )	275 V	320 V	385 V



Type DG MOD ...	E H LI 440	E H LI 1000	E H 1000
Part No.	952 905 <sup>NEW</sup>	952 907	952 908 <sup>NEW</sup>
Nominal discharge current (8/20 $\mu$ s) ( $I_n$ )	30 kA	20 kA	20 kA
Max. discharge current (8/20 $\mu$ s) ( $I_{max}$ )	65 kA	40 kA	40 kA
Max. continuous operating voltage (a.c.) ( $U_c$ )	440 V	1000 V	1000 V

### Varistor-based Protection Module for DEHNguard SE DC

Varistor-based protection module for DEHNguard SE DC surge arresters.

Type DG MOD ...	E DC 60	E DC 242	E DC 550	E DC 900
Part No.	972 010	972 020	972 030	972 040
Nominal discharge current (8/20 $\mu$ s) ( $I_n$ )	12.5 kA	12.5 kA	12.5 kA	12.5 kA
Max. continuous operating voltage (d.c.) ( $U_c$ )	60 V	242 V	550 V	900 V





## DEHNGuard® 1000



For protecting low voltage consumer's installations against surges. For installation in conformity with the lightning protection zone concept at the boundaries from  $O_B - 1$  and higher.

With a rated voltage of 1000 V, the compact and powerful single-pole DEHNGuard 1000 (FM) surge arresters can be used for a wide range of applications.

The DEHNGuard family is not only characterised by its high degree of flexibility, but also by its distinctive performance parameters which set standards worldwide: The high discharge capacity, low voltage protection level and dual "Thermo Dynamic Control" monitoring and disconnection device ensure maximum reliability.

The DEHN-specific "Thermo Dynamic Control" disconnecter ensures that the arresters change into a safe, isolated state even in case of extreme overload. For this purpose, the surface temperature of the heavy-duty varistor and the intensity of the discharge current are used for evaluation.

- High discharge capacity due to heavy-duty zinc oxide varistor
- Quick response
- High reliability due to "Thermo Dynamic Control" disconnecter
- Fault indication by green / red indicator flag in the inspection window
- Specifically designed for high system voltages

DEHNGuard 1000: Compact single-pole surge arrester with a rated voltage  $U_c = 1000 \text{ V a.c. or } 1000 \text{ V d.c.}$

DEHNGuard 1000 FM: With remote signalling contact for monitoring device (floating changeover contact)

The external design of the device reflects its field of application. DEHNGuard 1000 (FM), with a width of two modules, entirely fulfils all mechanical requirements resulting from the high system voltages.

Apart from the standard visual indication with green and red indicator flags, DEHNGuard 1000 (FM) arresters feature a three-pole remote signalling terminal. With its floating changeover contact, the remote signal can be used as a break or make contact according to the particular circuit concept.



## DEHNGuard 1000 (FM)

Compact single-pole surge arrester; FM version with floating remote signalling contact.

Type DG ...	1000	1000 FM
Part No.	950 102	950 112
SPD according to EN 61643-11 / IEC 61643-11	type 2 / class II	type 2 / class II
Max. continuous operating voltage (a.c.) ( $U_c$ )	1000 V (50 / 60 Hz)	1000 V (50 / 60 Hz)
Max. discharge current (8/20 $\mu\text{s}$ ) ( $I_{\text{max}}$ )	30 kA	30 kA
Voltage protection level ( $U_p$ )	$\leq 4.2 \text{ kV}$	$\leq 4.2 \text{ kV}$
Max. overcurrent protection	100 A aM	100 A aM
Max. overcurrent protection at $U \leq 690 \text{ V a.c.}$	125 A gG	125 A gG
Approvals	UL	UL
Type of remote signalling contact	—	changeover contact



## Accessories for DEHNGuard® 1000

## Earthing Clip for two-module Enclosures, single-phase, two-pole / three-pole / four-pole

Earthing clip for connecting the earth terminals of e.g. two/three/four SPDs with two-module enclosure and terminal to earth.

Type	EB 1 2 5	EB DG 1000 1 3	EB 1 4 9
Part No.	900 419	900 411	900 417
Dimensions	34 x 77 x 28 mm	34 x 112 x 28 mm	34 x 148 x 28 mm
Clamp	up to 25 mm <sup>2</sup>	up to 25 mm <sup>2</sup>	up to 25 mm <sup>2</sup>





## V NH / VA NH

- Surge arrester for use in NH 00 and 1 fuse holders
- Zinc oxide varistor with monitoring device, disconnecter and integrated backup fuse (VA NH... with additional spark gap connected in series)
- Energy coordination with other arresters of the Red/Line product family
- Fault indication by tripping indicator

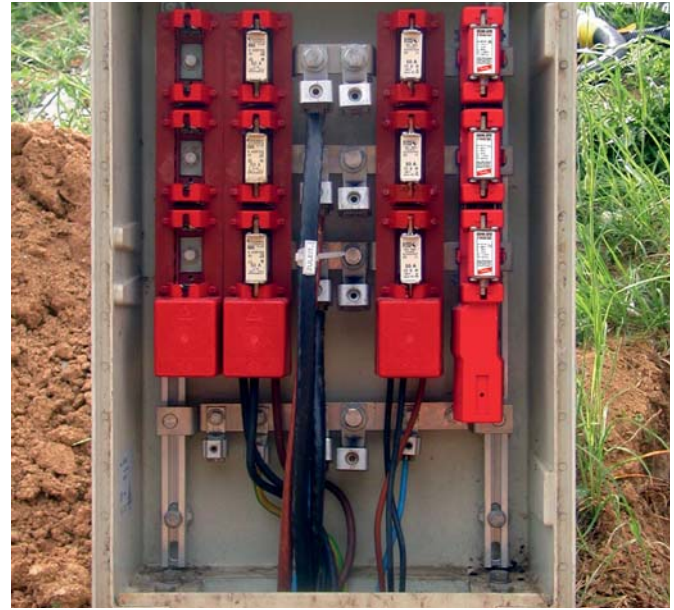

For protecting low voltage consumer's installations against surges. For installation in conformity with the lightning protection zone concept at the boundaries from  $O_B - 1$  and higher. German patented design.

V(A) NH00 280: Surge arrester for use in NH00 fuse holders

V(A) NH1 280: Surge arrester for use in NH1 fuse holders

V(A) NH00 280 FM: With fault indicator for remote signalling; allows for use of NH fuse holders with microswitch (max. tripping distance of indicator of 7 mm)

The single-pole V NH and VA NH surge arresters show that surge protective devices do not necessarily have to be designed for DIN rails or socket outlets. Adapted to the requirements in industrial sub-circuit distribution boards, V NH and VA NH surge arresters are designed in the form of an NH fuse holder. This allows to easily integrate them into busbar systems which are frequently used in the environment of utility operators or in industrial plants. Thus, these surge protective devices offer all the advantages of busbar systems such as easy installation, low installation time and reduced wiring. The idea of such a busbar system is consistently continued with arresters in NH design. V NH and VA NH surge arresters can be installed and removed by means of a fuse switch-disconnector and a fuse handle. This considerably facilitates insulation measurements in the installation as the arrester does not have to be disconnected any more.



Another considerable advantage of the V NH / VA NH family is that a backup fuse is already integrated in the arrester. In case of earth-fault and short-circuit-proof wiring, this considerably saves costs and reduces space requirements in distribution boards. In case of

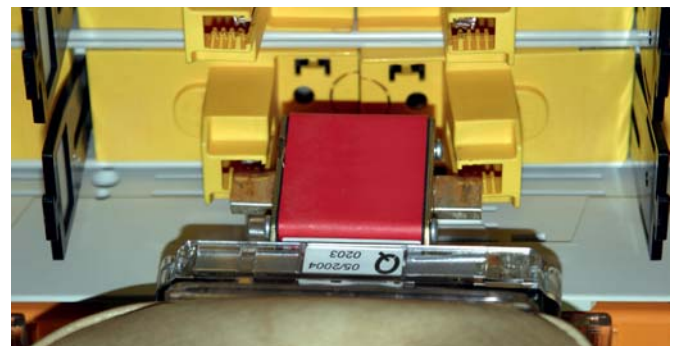

the VA NH version, a spark gap is connected in series with the heavy-duty zinc oxide varistor with thermal monitoring and disconnection device of the V NH surge arresters. VA NH devices are used to reliably protect large-scale systems with permanent insulation monitoring. Apart from the standard visual indication by a tripping indicator, V(A) NH ... FM surge arresters feature a microswitch integrated in the NH fuse holder for remote signalling.

### V NH00 (FM)

Varistor-based surge arrester with integrated backup fuse for use in NH00 fuse holders, optionally available with special indicator for remote signalling.



Type	V NH00 280	V NH00 280 FM
Part No.	900 261	900 263
SPD according to EN 61643-11 / IEC 61643-11	type 2 / class II	type 2 / class II
Max. continuous operating voltage (a.c.) ( $U_c$ )	280 V (50 / 60 Hz)	280 V (50 / 60 Hz)
Max. discharge current (8/20 $\mu$ s) ( $I_{max}$ )	30 kA	30 kA
Voltage protection level ( $U_p$ )	$\leq 1.5$ kV	$\leq 1.5$ kV
Max. mains-side overcurrent protection	not required	not required
Indicator for remote signalling	—	tripping distance of 7 mm

### V NH1

Varistor-based surge arrester with integrated backup fuse for use in NH1 fuse holders.



Type	V NH1 280
Part No.	900 270
SPD according to EN 61643-11 / IEC 61643-11	type 2 / class II
Max. continuous operating voltage (a.c.) ( $U_c$ )	280 V (50 / 60 Hz)
Max. discharge current (8/20 $\mu$ s) ( $I_{max}$ )	30 kA
Voltage protection level ( $U_p$ )	$\leq 1.5$ kV
Max. mains-side overcurrent protection	not required

### VA NH00 (FM)

Surge arrester based on a series-connected varistor and spark gap with integrated backup fuse; for use in NH00 fuse holders, optionally available with special indicator for remote signalling.



Type	VA NH00 280	VA NH00 280 FM
Part No.	900 262	900 264
SPD according to EN 61643-11 / IEC 61643-11	type 2 / class II	type 2 / Class II
Max. continuous operating voltage (a.c.) ( $U_c$ )	280 V (50 / 60 Hz)	280 V (50 / 60 Hz)
Max. discharge current (8/20 $\mu$ s) ( $I_{max}$ )	20 kA	20 kA
Voltage protection level ( $U_p$ )	$\leq 1.5$ kV	$\leq 1.5$ kV
Max. mains-side overcurrent protection	not required	not required
Indicator for remote signalling	—	tripping distance of 7 mm

### VA NH1

Surge arrester based on a series-connected varistor and spark gap with integrated backup fuse; for use in NH1 fuse holders.



Type	VA NH1 280
Part No.	900 271
SPD according to EN 61643-11 / IEC 61643-11	type 2 / class II
Max. continuous operating voltage (a.c.) ( $U_c$ )	280 V (50 / 60 Hz)
Max. discharge current (8/20 $\mu$ s) ( $I_{max}$ )	20 kA
Voltage protection level ( $U_p$ )	$\leq 1.5$ kV
Max. mains-side overcurrent protection	not required

Selection Chart

DIN rail	Cable duct / flush mounted system	Socket outlets (modules)	Socket outlets (adapters)	Acoustic fault indication	Visual fault indication	Remote signalling contact	Series connection	Type	Part No.	Page
•					•		•	DR M 2P 255	953 200	91
•					•	•	•	DR M 2P 255 FM	953 205	91
•					•		•	DR M 4P 255	953 400	92
•					•	•	•	DR M 4P 255 FM	953 405	92
•					•		•	SPS PRO	912 253	95
	•	•			•		•	DSA 230 LA	924 370	97
	•	•			•			NSM PRO ...	924 33X	98
	•	•		•				STC 230	924 350	99
	•	•		•				DFL M 255	924 396	101
	•	•		•				DFL A 255	924 389	101
	•	•		•			•	DFL D 255	924 395	101
			•		•			DPRO 230	909 230	103
			•		•			DPRO 230 F	909 240	103
			•		•			SFL PRO 6X	909 250	104
			•		•			SFL PRO 6X 19"	909 251	104



## DEHnrail modular



For protecting the power supply circuits of industrial electronics equipment against transients in switchgear cabinets. For installation in conformity with the lightning protection zone concept at the boundaries from 1 – 2 and higher.

- Two-pole surge arrester consisting of a base part and a plug-in protection module
- High discharge capacity due to heavy-duty zinc oxide varistor / spark gap combination
- Energy coordination with other arresters of the Red/Line product family
- Operating state / fault indication by green / red indicator flag in the inspection window
- Narrow (modular) design according to DIN 43880
- Easy replacement of protection modules due to module locking system with module release button
- Vibration and shock-tested according to EN 60068-2

**DEHnrail M 2P ...:** Two-pole surge arrester consisting of a base part and a plug-in protection module  
**DEHnrail M 2P ... FM:** With remote signalling contact for monitoring device (floating changeover contact)

The modular devices of the DEHnrail M product family stand out due to their high performance parameters and straightforward Red/Line design. The devices combine safety and ease of use in a single module. The low voltage protection level and the comprehensive protection against common-mode and differential-mode interference make them ideal for protecting terminal equipment in industrial electronics environments. The input and output terminals for series connection and the protective circuit designed for high load currents underline this concept.

The very compact design of the DEHnrail M surge arresters includes the fault-proof Y protective circuit and a combined SPD monitoring and disconnection device.

The base part and protection module are coded to ensure against installing an incorrect module.

The unique module locking system of the DEHnrail M product family fixes the protection module to the base part. Neither vibration during transport nor the electrodynamic forces of discharge can loosen the connection.

In the event of the protective circuit being overloaded, the protection modules can be easily replaced without tools by simply pressing the module release button.



In addition to the standard visual indication with green and red indicator flags, DEHnrail M ... FM devices feature a three-pole remote signalling terminal. With its floating changeover contact, the remote signal can be used as a break or make contact according to the particular circuit concept.

### DEHNrail M 2P ...

Two-pole surge arrester consisting of a base part and plug-in protection module.

General technical data:			
SPD according to EN 61643-11 / IEC 61643-11	type 3 / class III		
Max. mains-side overcurrent protection	25 A gG or B 25 A		
Approvals	KEMA, VDE, UL, VdS, CSA		
Type DR M 2P ...	30	60	75
Part No.	953 201	953 202	953 203
Max. continuous operating voltage (a.c.) ( $U_c$ )	30 V (50 / 60 Hz)	60 V (50 / 60 Hz)	75 V (50 / 60 Hz)
Max. continuous operating voltage (d.c.) ( $U_c$ )	30 V	60 V	75 V
Nominal discharge current (8/20 $\mu$ s) ( $I_n$ )	1 kA	1 kA	2 kA
Total discharge current (8/20 $\mu$ s) [L+N-PE] ( $I_{total}$ )	2 kA	2 kA	4 kA
Voltage protection level [L-N] / [L/N-PE] ( $U_p$ )	$\leq 180 / \leq 630$ V	$\leq 350 / \leq 730$ V	$\leq 400 / \leq 730$ V
Type DR M 2P ...	150	255	
Part No.	953 204	953 200	
Max. continuous operating voltage (a.c.) ( $U_c$ )	150 V (50 / 60 Hz)	255 V (50 / 60 Hz)	
Max. continuous operating voltage (d.c.) ( $U_c$ )	150 V	255 V	
Nominal discharge current (8/20 $\mu$ s) ( $I_n$ )	2 kA	3 kA	
Total discharge current (8/20 $\mu$ s) [L+N-PE] ( $I_{total}$ )	4 kA	5 kA	
Voltage protection level [L-N] / [L/N-PE] ( $U_p$ )	$\leq 640 / \leq 800$ V	$\leq 1250 / \leq 1500$ V	



### DEHNrail M 2P ... FM

Two-pole surge arrester consisting of a base part and plug-in protection module; with floating remote signalling contact.

General technical data:			
SPD according to EN 61643-11 / IEC 61643-11	type 3 / class III		
Max. mains-side overcurrent protection	25 A gG or B 25 A		
Approvals	KEMA, VDE, UL, VdS, CSA		
Type of remote signalling contact	changeover contact		
Type DR M 2P ...	30 FM	60 FM	75 FM
Part No.	953 206	953 207	953 208
Max. continuous operating voltage (a.c.) ( $U_c$ )	30 V (50 / 60 Hz)	60 V (50 / 60 Hz)	75 V (50 / 60 Hz)
Max. continuous operating voltage (d.c.) ( $U_c$ )	30 V	60 V	75 V
Nominal discharge current (8/20 $\mu$ s) ( $I_n$ )	1 kA	1 kA	2 kA
Total discharge current (8/20 $\mu$ s) [L+N-PE] ( $I_{total}$ )	2 kA	2 kA	4 kA
Voltage protection level [L-N] / [L/N-PE] ( $U_p$ )	$\leq 180 / \leq 630$ V	$\leq 350 / \leq 730$ V	$\leq 400 / \leq 730$ V
Type DR M 2P ...	150 FM	255 FM	
Part No.	953 209	953 205	
Max. continuous operating voltage (a.c.) ( $U_c$ )	150 V (50 / 60 Hz)	255 V (50 / 60 Hz)	
Max. continuous operating voltage (d.c.) ( $U_c$ )	150 V	255 V	
Nominal discharge current (8/20 $\mu$ s) ( $I_n$ )	2 kA	3 kA	
Total discharge current (8/20 $\mu$ s) [L+N-PE] ( $I_{total}$ )	4 kA	5 kA	
Voltage protection level [L-N] / [L/N-PE] ( $U_p$ )	$\leq 640 / \leq 800$ V	$\leq 1250 / \leq 1500$ V	





## DEHNRail modular, multipole



For protecting the power supply circuits of industrial electronics equipment against transients in switchgear cabinets. For installation in conformity with the lightning protection zone concept at the boundaries from 1 – 2 and higher.

- Four-pole surge arrester consisting of a base part and a plug-in protection module
- High discharge capacity due to heavy-duty zinc oxide varistor / spark gap combination
- Energy coordination with other arresters of the Red/Line product family
- Operating state / fault indication by green / red indicator flag in the inspection window
- Easy replacement of protection modules without tools due to module locking system with module release button
- Nominal load currents up to 25 A
- Vibration and shock-tested in accordance with EN 60068-2

**DEHNRail M 4P ...:** Four-pole surge arrester consisting of a base part and a plug-in protection module

**DEHNRail M 4P ... FM:** With remote signalling contact for monitoring device (floating changeover contact)

The modular four-pole DEHNRail M 4P ... (FM) surge arresters are specifically developed for protecting three-phase industrial electronics terminal equipment. Adapted to this kind of environment, the arresters with the Red/Line design are suitable for 35 mm DIN rails. The low voltage protection level and the comprehensive protection against common-mode and differential-mode interference are characteristic of DEHNRail M 4P ... (FM). To provide optimal low voltage protection levels for the terminal equipment to be protected, the device features input and output terminals for series connection. DEHNRail M 4P ... (FM) devices ideally adapt to the cable run upstream of the terminal equipment. Therefore, no additional terminal blocks for outgoing cables are required. The compact design incorporates the tried and tested disconnecter. It disconnects an overloaded arrester circuit without interrupting the supply circuit.

The base part and protection module are coded to ensure against installing the incorrect module.

The unique module locking system of the DEHNRail M family fixes the protection modules to the base part. Neither vibrations during transport nor the electrodynamic forces of discharge can loosen the connection.

In the event of the protective circuit, which is rated for high load currents up to 25 A, being overloaded, the protection modules can be easily replaced without tools by simply pressing the module release button.

Apart from the standard visual indication with green and red indicator flags, DEHNRail M 4P ... FM devices feature a three-pole remote signalling terminal. With its floating changeover contact, the remote signal can be used as a break or make contact according to the particular circuit concept.

### DEHN rail M 4P ... (FM)

Four-pole surge arrester consisting of a base part and a plug-in protection module for 230 / 400 V systems; FM version with floating remote signalling contact.



Type DR M 4P ...	255	255 FM
Part No.	953 400	953 405
SPD according to EN 61643-11 / IEC 61643-11	type 3 / class III	type 3 / class III
Max. continuous operating voltage (a.c.) (U <sub>c</sub> )	255 / 440 V (50 / 60 Hz)	255 / 440 V (50 / 60 Hz)
Nominal discharge current (8/20 μs) (I <sub>n</sub> )	3 kA	3 kA
Total discharge current (8/20 μs) [L1+L2+L3+N-PE] (I <sub>total</sub> )	8 kA	8 kA
Voltage protection level [L-N] / [L/N-PE] (U <sub>p</sub> )	≤ 1000 / ≤ 1500 V	≤ 1000 / ≤ 1500 V
Max. mains-side overcurrent protection	25 A gG or B 25 A	25 A gG or B 25 A
Approvals	KEMA, VDE	KEMA, VDE
Type of remote signalling contact	—	changeover contact

## Protection Module for DEHNrail modular

- High discharge capacity due to heavy-duty zinc oxide varistor / spark gap combination
- High reliability due to “Thermo Dynamic Control” disconnecter with dual monitoring
- Energy coordination with other arresters of the Red/Line product family
- Easy replacement of protection modules without tools due to module locking system with module release button
- Operating state / fault indication by green / red indicator flag in the inspection window
- The plug-in protection module can be replaced without the need to de-energise and without removing the distribution board cover
- Vibration and shock-tested in accordance with EN 60068-2

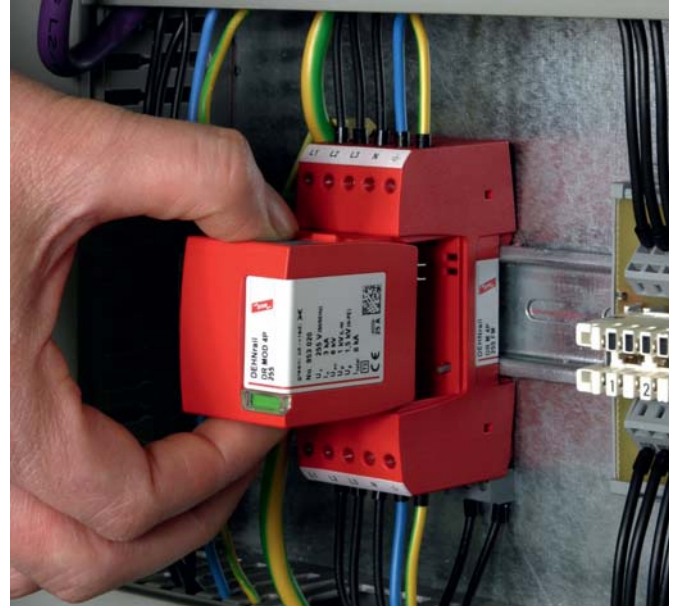

For protecting the power supply circuits of industrial electronics equipment against surges in switchgear cabinets. For installation in conformity with the lightning protection zone concept at the boundaries from 1 – 2 and higher.

DEHNrail MOD ...: For all types of two-pole DEHNrail M 2P ... surge arresters

DEHNrail MOD 4P...: For all types of four-pole DEHNrail M 4P ... surge arresters

## Protection Module for DEHNrail M 2P

Protection module with integrated Y protective circuit.

Type DR MOD ...	30	60	75
Part No.	953 011	953 012	953 013
Nominal discharge current (8/20 $\mu$ s) ( $I_n$ )	1 kA	1 kA	2 kA
Total discharge current (8/20 $\mu$ s) [L+N-PE] ( $I_{total}$ )	2 kA	2 kA	4 kA
Max. continuous operating voltage (a.c.) ( $U_c$ )	30 V	60 V	75 V

Type DR MOD ...	150	255
Part No.	953 014	953 010
Nominal discharge current (8/20 $\mu$ s) ( $I_n$ )	2 kA	3 kA
Total discharge current (8/20 $\mu$ s) [L+N-PE] ( $I_{total}$ )	4 kA	5 kA
Max. continuous operating voltage (a.c.) ( $U_c$ )	150 V	255 V



## Protection Module for DEHNrail M 4P

Four-pole protection module with integrated protective circuit.

Type DR MOD ...	4P 255
Part No.	953 020
Nominal discharge current (8/20 $\mu$ s) ( $I_n$ )	3 kA
Total discharge current (8/20 $\mu$ s) [L+N-PE] ( $I_{total}$ )	8 kA
Max. continuous operating voltage (a.c.) ( $U_c$ )	255 V





## NF 10 Mains Filter

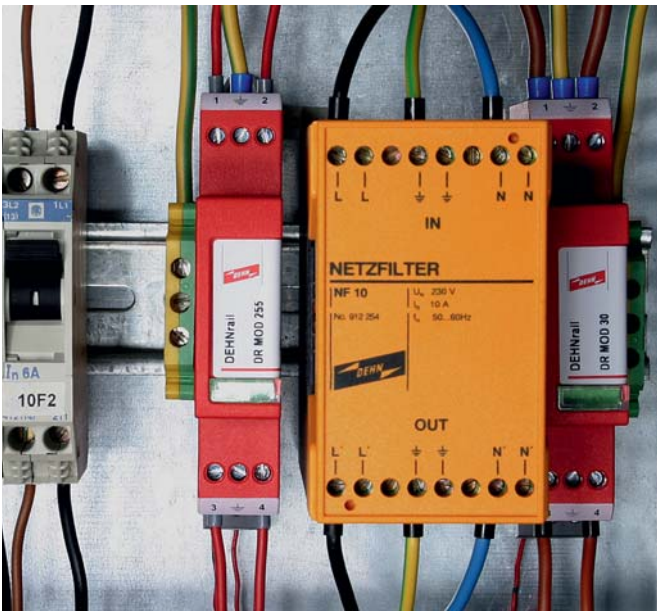

- Protection of sensitive industrial electronics equipment against balanced and unbalanced high-frequency interference
- For use in combination with surge protective devices, e.g. DEHNrail M 2P 255
- Easy installation on DIN rails in switchgear cabinets

The NF 10 mains filters ideally complements surge protective devices for industrial terminal equipment. The DIN rail mounted mains filters are perfectly suited for installation downstream of surge protective devices (e.g. DEHNrail M 2P 255). In addition to surge protection, protection against balanced and unbalanced high-frequency interference is provided. The

separate input and output terminals of the mains filter ensure optimal protection of the equipment to be protected. Apart from surge protection, the mains filter also fulfils electromagnetic compatibility requirements in plant and control systems.

## NF 10

Mains filter for protection against balanced and unbalanced interferences.



Type	NF 10
Part No.	912 254
Nominal voltage (a.c.) ( $U_N$ )	230 V
Nominal load current (a.c.) ( $I_N$ )	10 A
Attenuation for $f = 1$ MHz, balanced	> 64 dB
Attenuation for $f = 1$ MHz, unbalanced	> 69 dB





## SPS Protector

### Two-pole surge arrester with filter

- Combination of surge protection and filter
- Surge protection with monitoring device and disconnecter
- Interference suppressor filter for protecting sensitive industrial electronics equipment against balanced and unbalanced high-frequency interference
- Installation in a shielded enclosure
- Visual operating state indication (green) and floating remote signalling contact (break contact) for fault indication

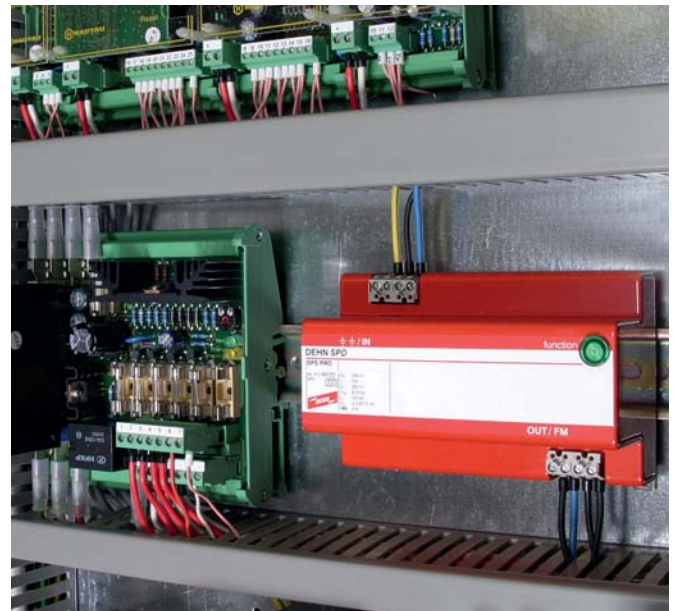

For protecting the power supply circuits of industrial electronics equipment (e.g. programmable logic controls (PLCs)) against transients and high-frequency interference voltages. For installation in conformity with the lightning protection zone concept at the boundaries from 1 – 2 and higher.

### SPS Protector: Two-pole surge arrester with interference suppressor filter

The SPS Protector combines surge protection and interference suppressor filter in a compact device. This makes it ideal for protecting sensitive terminal equipment of industrial automation systems (e.g. programmable logic controls (PLCs)). The coordinated surge protection and filter functions complement one another and prevent core saturation of the filter in the event of high-level transients. The separate input and output terminals provide optimal protection for the device to be protected. The metal enclosure of the SPS Protector ensures that high-frequency interferences are discharged without interfering with other devices in the immediate vicinity. The compact design of the SPS Protector already houses the proven disconnecter. In case of overload, it disconnects the arrester without interrupting the power supply circuit. Apart from the green indicator light, SPS Protectors also feature a remote signalling contact.



### SPS Protector

Surge arrester with interference suppressor filter for single-phase 230 V TT and TN systems; with floating remote signalling contact.

Type	SPS PRO
Part No.	912 253
SPD according to EN 61643-11 / IEC 61643-11	type 3 / class III
Max. continuous operating voltage (a.c.) ( $U_c$ )	255 V (50 / 60 Hz)
Nominal load current (a.c.) ( $I_n$ )	3 A
Nominal discharge current (8/20 $\mu$ s) ( $I_n$ )	3 kA
Total discharge current (8/20 $\mu$ s) [L+N-PE] ( $I_{total}$ )	5 kA
Voltage protection level [L-N] / [L/N-PE] ( $U_p$ )	$\leq 800$ / $\leq 1000$ V
Type of remote signalling contact	break contact





## DEHNsafe



For protecting electronic devices against surges. For installation in electrical installation systems, e.g. cable ducts or flush-type boxes. For installation in conformity with the lightning protection zone concept at the boundaries from 1 – 2 and higher.

## DEHNsafe 230 LA: Surge protective device for use in cable ducts

DEHNsafe surge arresters particularly stand out due to their flexible application options. Due to their small mounting depth of only 31 mm, the two-pole surge protective devices for 230 V terminal equipment can be installed both in cable ducts and in flat flush-type boxes. DEHNsafe incorporates a monitoring device and a thermal disconnecter. In addition to a visual operating state indicator, the device features a programmable acoustic fault indicator which can be programmed for three different operating states:

- Acoustic fault indication,
- Test function,
- Muting of the acoustic signal.

- Two-pole surge protective device for 230 V terminal equipment
- For use in flush-type boxes and cable ducts
- Enhanced safety due to fault-proof Y protective circuit
- Multiple indicator
- Programmable acoustic function
- Terminals for series connection
- Independent of the socket outlet design



DEHNsafe surge arresters are covered by a triple TAE cover from any switch range manufacturer, thus ideally adapting to any socket outlet design.

The double terminals for L, N and PE allow for series connection to ensure that the surge protective device is situated in parallel to the circuit to be protected. For this reason, DEHNsafe does not necessarily interrupt the circuit to be protected in case of overload. They feature a green and red LED for visual inspection.

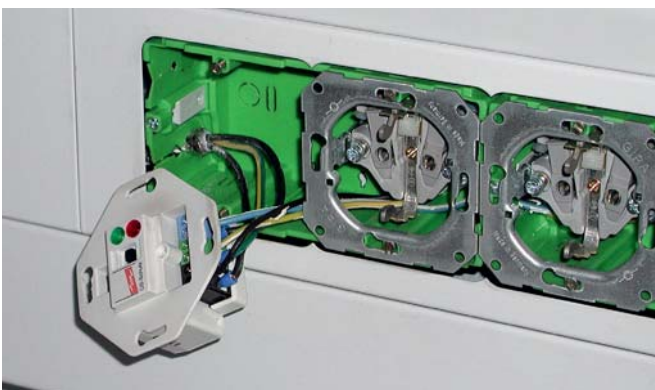

## Surge Arresters – Type 3

### DEHNsafe

Surge protective device for use in cable ducts and flush-type boxes. For single-phase 230 V TT and TN systems.

Type	DSA 230 LA
Part No.	924 370
SPD according to EN 61643-11 / IEC 61643-11	type 3 / class III
Max. continuous operating voltage (a.c.) ( $U_c$ )	255 V (50 / 60 Hz)
Nominal discharge current (8/20 $\mu$ s) ( $I_n$ )	3 kA
Total discharge current (8/20 $\mu$ s) [L+N-PE] ( $I_{total}$ )	5 kA
Voltage protection level [L-N] / [L/N-PE] ( $U_p$ )	$\leq 1250$ / $\leq 1500$ V
Max. mains-side overcurrent protection	B 16 A
Fault indication	red light + acoustic signal
Operating state indication	green light



### Accessories for DEHNsafe

#### Central Covering Plate

Single unit, alpha exclusive.

Type	ZAP STW
Part No.	924 329
Colour	studio white



#### Cover Frame

Single unit, alpha exclusive.

Type	AR1 STW
Part No.	924 328
Colour	studio white





## NSM Protector



- Surge protection with monitoring device and disconnector
- Enhanced safety due to fault-proof Y protective circuit
- Visual operating state (green) and fault indication (red)
- With retaining ring (diameter of 60 mm) for installation in switch boxes with a diameter of 60 mm and a depth of 40 mm

For protecting electronic equipment against surges. Earthed socket outlet with surge protective circuit for installation in electrical installation systems. For installation in conformity with the lightning protection zone concept at the boundaries from 1 – 2 and higher. German utility patent.

## NSM Protector: Earthed socket outlet with integrated surge protection

The devices of the NSM Protector family combine surge protection and earthed socket outlet in a single device. The two-pole surge arresters are specifically designed for protecting electronic loads in final circuits. Their very compact design incorporates the approved disconnector which disconnects overloaded surge arresters without interrupting the supply circuit. The low voltage protection level as well as the comprehensive pro-

tection against common-mode and differential-mode interference are typical of the devices of the NSM Protector family. The fault-proof Y protective circuit ensures safety even if the phase and neutral conductors in final circuits cannot be identified. The integrated disconnector ensures reliability of devices and installations. The standard green and red LEDs indicate the operating state of the surge protective devices.

## NSM PRO

Socket outlet with surge protection for single-phase 230 V TT and TN systems.



Type NSM PRO ...	TW	SI
Part No.	924 335	924 337
SPD according to EN 61643-11 / IEC 61643-11	type 3 / class III	type 3 / class III
Max. continuous operating voltage (a.c.) ( $U_c$ )	255 V (50 / 60 Hz)	255 V (50 / 60 Hz)
Nominal discharge current (8/20 $\mu$ s) ( $I_n$ )	3 kA	3 kA
Total discharge current (8/20 $\mu$ s) [L+N-PE] ( $I_{total}$ )	5 kA	5 kA
Voltage protection level [L-N] / [L/N-PE] ( $U_p$ )	$\leq 1250 / \leq 1500$ V	$\leq 1250 / \leq 1500$ V
Max. mains-side overcurrent protection	B 16 A	B 16 A
Fault indication	red light	red light
Operating state indication	green light	green light

## Accessories for NSM Protector



## AR1 Cover Frame

Single unit, suitable for NSM Protector.

Type	AR1 TW	AR1 SI
Part No.	924 336	924 338
Type	DELTA profil, titanium white	DELTA profil, silver



## STC Module

### Surge arrester for earthed socket outlets

- Two-pole surge arrester with monitoring device and disconnecter
- Enhanced safety due to fault-proof Y protective circuit
- Acoustic fault indication
- For installation in standard earthed socket outlets
- Independent of the socket outlet design
- Plastic snap-on retaining ring for easy installation in already mounted socket outlets

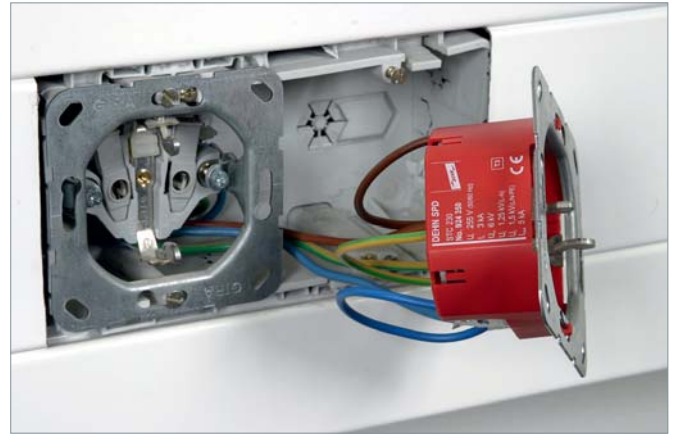

For protecting electronic devices against surges. For use with standard earthed socket outlets. For installation in conformity with the lightning protection zone concept at the boundaries from 1 – 2 and higher.

### STC 230: Snap-on module for standard earthed socket outlets

The well received STC surge protection module can be fitted inconspicuously. The two-pole surge arrester can be installed on the rear side of standard earthed socket outlets. The STC surge protection module thus adapts to every type of socket outlet. The plastic snap-on retaining ring allows easy installation even in already mounted earthed socket outlets. In addition to a thermal disconnecter, the protective device features an acoustic fault indication. As the surge protection module is installed in

parallel to the socket outlet, the power supply of the connected loads remains uninterrupted, even if the surge arrester is overloaded.

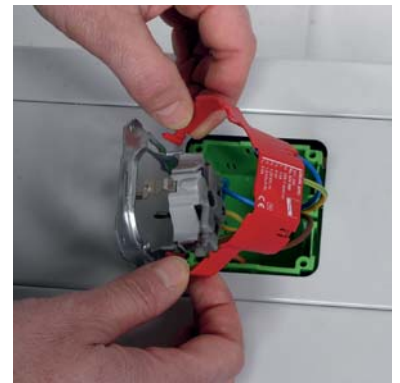

### STC 230

Two-pole surge arrester for 230 V TT and TN systems is snapped on earthed socket outlets.

Type	STC 230
Part No.	924 350
SPD according to EN 61643-11 / IEC 61643-11	type 3 / class III
Max. continuous operating voltage (a.c.) ( $U_c$ )	255 V (50 / 60 Hz)
Nominal discharge current (8/20 $\mu$ s) ( $I_n$ )	3 kA
Total discharge current (8/20 $\mu$ s) [L+N-PE] ( $I_{total}$ )	5 kA
Voltage protection level [L-N] / [L/N-PE] ( $U_p$ )	$\leq 1250 / \leq 1500$ V
Max. mains-side overcurrent protection	B 16 A
Fault indication	acoustic signal on

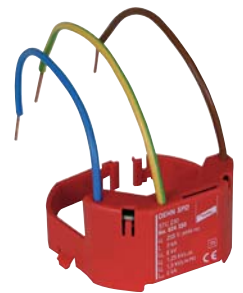



## DEHNflex

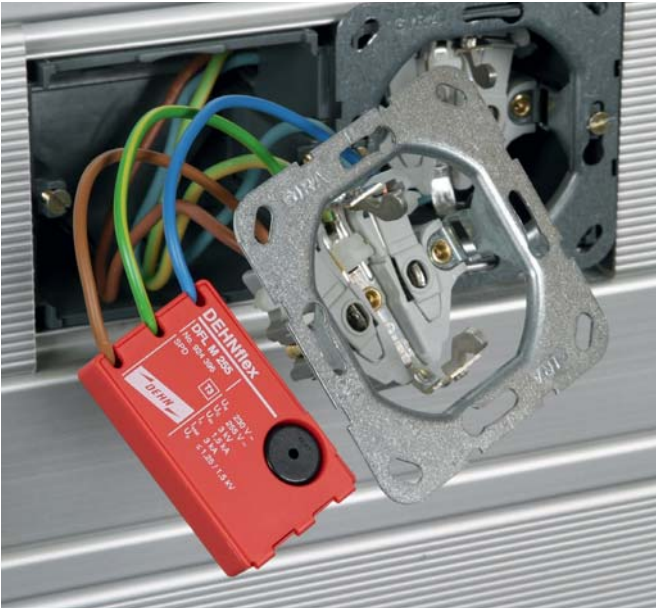

- Two-pole surge arrester with monitoring device and disconnecter
- Enhanced safety due to fault-proof Y protective circuit
- Acoustic fault indication
- Compact design
- For use in flush-mounted systems, cable ducts and flush-type boxes

For protecting electronic equipment against surges. For installation in electrical installation systems, e.g. flush-mounted systems, cable ducts and flush-type boxes. German utility patent for DEHNflex A / ... D. For installation in conformity with the lightning protection zone concept at the boundaries from 1 – 2 and higher.

**DEHNflex M:** Compact design; for use in cable duct systems and flush-type boxes

**DEHNflex A:** For use in any cable duct systems or flush-type boxes; with test function

**DEHNflex D:** Like DEHNflex A, but for series connection of several socket outlets

As the name suggests, the DEHNflex family offers almost unlimited application options. Being two-pole surge arresters, the compact modules are ideally suited for protecting electronic loads in final circuits. The design was adapted to the most common places of installation, that is cable ducts and flush-type boxes. DEHNflex devices show that small and compact dimensions do not necessarily mean that surge arresters are inefficient. The fault-proof Y protective circuit always ensures safety even if the phase and neutral conductors cannot be identified. Apart from the powerful Y circuit, the compact enclosure also houses a disconnecter and an acoustic fault indicator. Be it in cable ducts, flush-mounted systems, branching boxes or device casings – DEHNflex is always installed in the right place close to terminal equipment.



### DEHNflex M

Surge arrester for single-phase 230 V TT and TN systems for use in all installation systems of terminal equipment; compact dimensions.

Type DFL ...	M 255
Part No.	924 396
SPD according to EN 61643-11 / IEC 61643-11	type 3 / class III
Max. continuous operating voltage (a.c.) ( $U_c$ )	255 V (50 / 60 Hz)
Nominal discharge current (8/20 $\mu$ s) ( $I_n$ )	1.5 kA
Total discharge current (8/20 $\mu$ s) [L+N-PE] ( $I_{total}$ )	3 kA
Voltage protection level [L-N] / [L/N-PE] ( $U_p$ )	$\leq 1250$ / $\leq 1500$ V
Max. mains-side overcurrent protection	B 16 A
Fault indication	acoustic signal on
Dimensions	30 x 50 x 11 mm



### DEHNflex A

Surge arrester for single-phase 230 V TT and TN systems for use in all installation systems of terminal equipment; with test function; compact dimensions.

Type DFL ...	A 255
Part No.	924 389
SPD according to EN 61643-11 / IEC 61643-11	type 3 / class III
Max. continuous operating voltage (a.c.) ( $U_c$ )	255 V (50 / 60 Hz)
Nominal discharge current (8/20 $\mu$ s) ( $I_n$ )	3 kA
Total discharge current (8/20 $\mu$ s) [L+N-PE] ( $I_{total}$ )	5 kA
Voltage protection level [L-N] / [L/N-PE] ( $U_p$ )	$\leq 1250$ / $\leq 1500$ V
Max. mains-side overcurrent protection	B 16 A
Fault indication	acoustic signal on
Dimensions	36 x 46 x 19 mm



### DEHNflex D

Surge arrester for single-phase 230 V TT and TN systems for use in all installation systems of terminal equipment; allows series connection; with test function; compact dimensions.

Type DFL ...	D 255
Part No.	924 395
SPD according to EN 61643-11 / IEC 61643-11	type 3 / class III
Max. continuous operating voltage (a.c.) ( $U_c$ )	255 V (50 / 60 Hz)
Nominal discharge current (8/20 $\mu$ s) ( $I_n$ )	3 kA
Total discharge current (8/20 $\mu$ s) [L+N-PE] ( $I_{total}$ )	5 kA
Voltage protection level [L-N] / [L/N-PE] ( $U_p$ )	$\leq 1250$ / $\leq 1500$ V
Max. mains-side overcurrent protection	B 16 A
Fault indication	acoustic signal on
Dimensions	36 x 46 x 19 mm





## VC 280 2

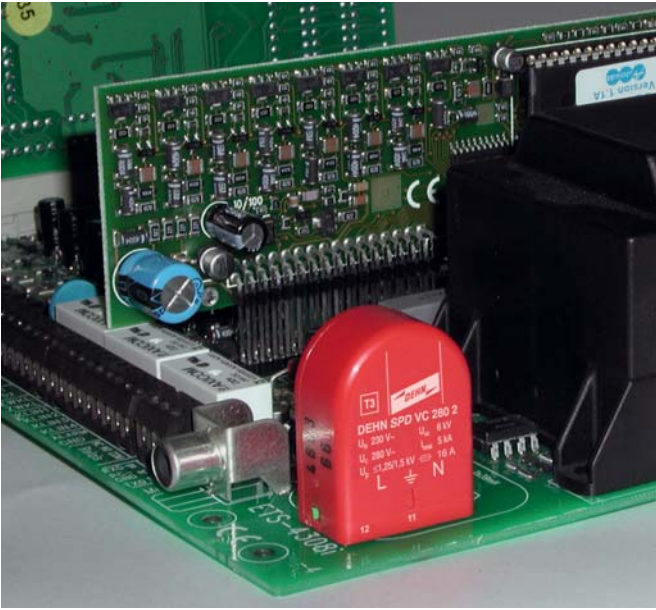

- Two-pole surge arrester with monitoring device and disconnecter
- Complete surge protective device for devices with a.c. voltage supply
- Enhanced safety due to fault-proof Y protective circuit
- Floating remote signalling contact (break contact) with test option for fault indicator
- For installation on printed circuit boards

VC 280 2 protects electronic equipment against surges. It is installed in the enclosure or directly in the device to be protected in conformity with the lightning protection zone concept at the boundaries from 1 – 2 and higher. German utility patent.

#### VC 280 2: Mains module with integrated surge protection for installation in the terminal device to be protected

VC 280 2 surge arresters are small, but no less complex. The two-pole module incorporates a fault-proof Y protective circuit, a monitoring and disconnection device as well as a floating remote signalling contact, thus ensuring compact dimensions and maximum safety. The surge arresters

even feature an integrated test option for the fault indicator. VC 280 2 reliably protects electronic equipment against overvoltage. The solder pins of VC 280 2 surge arresters allow to install them directly on the PCBs of the device to be protected.

#### VC 280 2

Mains module with integrated surge protection and floating break contact for installation into the terminal equipment to be protected.



Type	VC 280 2
Part No.	900 471
SPD according to EN 61643-11 / IEC 61643-11	type 3 / class III
Max. continuous operating voltage (a.c.) ( $U_c$ )	280 V (50 / 60 Hz)
Nominal discharge current (8/20 $\mu$ s) ( $I_n$ )	3 kA
Total discharge current (8/20 $\mu$ s) [L+N-PE] ( $I_{total}$ )	5 kA
Voltage protection level [L-N] / [L/N-PE] ( $U_p$ )	$\leq 1250 / \leq 1500$ V
Max. mains-side overcurrent protection	B 16 A
Fault indication	remote signalling contact (break contact)





## DEHNprotector

- Surge protection with monitoring device and disconnecter
- Visual operating state (green) and fault indication (red)
- Mains filter (DEHNpro 230 F Protector only)
- Enhanced safety due to fault-proof Y protective circuit



The adapter protects the power supply circuits of electronic equipment against transients and high-frequency interference voltages (DEHNpro 230 F Protector). For installation in conformity with the lightning protection zone concept at the boundaries from 1 – 2 and higher.

**DEHNpro 230:** Protection of terminal equipment

**DEHNpro 230 F:** Protection of terminal equipment with mains filter

The adapters with integrated surge protection of the DEHNpro family protect electronic loads connected to final circuits from overvoltage. An interference suppressor filter with a balancing and unbalancing effect was integrated in the powerful surge protective circuit of DEHNpro 230 Protectors. This combination of surge protection and filter prevents a core saturation of the filter in case of high-level transients. The nominal current carrying capability of 16 A (DEHNpro 230) and 10 A (230 F Protector) allows flexible use of these devices in final circuits. The fault-proof Y circuit ensures protection even if the phase and neutral conductors in standard earthed socket outlets cannot be identified. The integrated disconnecter ensures reliability of devices and installations. The standard green and red LEDs indicate the operating state of the surge protective devices.

The modern design of the DEHNpro devices and the use of high-quality materials ensure safety in a sophisticated appearance. The DEHNpro

devices thus ideally adapt to the installation environment. They create the right technical environment already at the socket outlet for connecting the latest communication and multimedia systems. The curved enclosure surfaces and the smooth surface structure ensure that the DEHNpro devices will not lose their original properties even after several years of application.



For more detailed information on adapters with integrated surge protection for protecting the power supply circuits and data interfaces of electronic devices, please refer to pages 194 – 195.

### DPRO 230 Protector

Adapter with integrated surge protection and child lock.

Type DPRO ...	<b>230</b>
Part No.	<b>909 230</b>
SPD according to EN 61643-11 / IEC 61643-11	type 3 / class III
Max. continuous operating voltage (a.c.) ( $U_C$ )	255 V (50 / 60 Hz)
Nominal discharge current (8/20 $\mu$ s) ( $I_n$ )	3 kA
Total discharge current (8/20 $\mu$ s) [L+N-PE] ( $I_{total}$ )	5 kA
Voltage protection level [L-N] / [L/N-PE] ( $U_P$ )	$\leq 1250 / \leq 1500$ V
Max. mains-side overcurrent protection	B 16 A
Fault indication	red light
Operating state indication	green light



### DPRO 230 F Protector

Adapter with integrated surge protection, mains filter and child lock.

Type DPRO ...	<b>230 F</b>
Part No.	<b>909 240</b>
SPD according to EN 61643-11 / IEC 61643-11	type 3 / class III
Max. continuous operating voltage (a.c.) ( $U_C$ )	255 V (50 / 60 Hz)
Nominal discharge current (8/20 $\mu$ s) ( $I_n$ )	3 kA
Total discharge current (8/20 $\mu$ s) [L+N-PE] ( $I_{total}$ )	5 kA
Voltage protection level [L-N] / [L/N-PE] ( $U_P$ )	$\leq 1250 / \leq 1500$ V
Max. mains-side overcurrent protection	B 16 A
Fault indication	red light
Operating state indication	green light





## SFL Protector



Multiple socket outlet for protecting the power supply circuits of electronic equipment against transients and high-frequency interference voltages. For installation in conformity with the lightning protection zone concept at the boundaries from 1 – 2 and higher.

The SFL Protector surge arrester complements the wide range of Red/Line surge protective devices. The combination of surge protection and mains filter makes the six-way socket outlet a powerful device for protecting electronic loads in final circuits. The harmonised surge protection and filter functions complement one another and prevent core saturation of the filter in case of high-level transients. The integrated mains filter is optimised for protection against balanced and unbalanced high-frequency interferences. The nominal current carrying capability of 16 A allows flexible use of these devices in final circuits.

The fault-proof Y protection circuit ensures protection even if the phase and neutral conductors in standard earthed socket outlets cannot be identified. The standard green and red LEDs indicate the operating state of the surge protective device.

The SFL PRO 6X 19" has been specifically developed for use in network cabinets and therefore provides optimal protection for terminal equipment in this critical field of application.

- Surge protection with monitoring device and disconnect
- Interference suppressor filter
- Enhanced safety due to fault-proof Y protective circuit
- Mains switch with operating state indication (SFL PRO 6X only)
- 2 m connection cable for flexible use in a wide range of applications
- Visual operating state (green) and fault indicator (red)

**SFL PRO 6X:** Surge protective multiple socket outlet with interference suppressor filter

**SFL PRO 6X 19":** Surge protective multiple socket outlet with mains filter for 482.6 mm (19 inch) data cabinets



## SFL PRO 6X

Surge protective multiple socket outlet with mains filter.

Type SFL PRO ...	6X
Part No.	909 250
SPD according to EN 61643-11 / IEC 61643-11	type 3 / class III
Max. continuous operating voltage (a.c.) ( $U_c$ )	255 V (50 / 60 Hz)
Nominal discharge current (8/20 $\mu$ s) ( $I_n$ )	3 kA
Total discharge current (8/20 $\mu$ s) [L+N-PE] ( $I_{total}$ )	5 kA
Voltage protection level ( $U_p$ )	$\leq 1.5$ kV
Max. mains-side overcurrent protection	B 16 A
Number of socket outlets	6



## SFL PRO 19"

Surge protective multiple socket outlet with mains filter for 482.6 mm (19 inches) data cabinets.

Type SFL PRO ...	6X 19"
Part No.	909 251
SPD according to EN 61643-11 / IEC 61643-11	type 3 / class III
Max. continuous operating voltage (a.c.) ( $U_c$ )	255 V (50 / 60 Hz)
Nominal discharge current (8/20 $\mu$ s) ( $I_n$ )	3 kA
Total discharge current (8/20 $\mu$ s) [L+N-PE] ( $I_{total}$ )	5 kA
Voltage protection level ( $U_p$ )	$\leq 1.5$ kV
Max. mains-side overcurrent protection	B 16 A
Number of socket outlets	6





**DEHNpanel**

- Remote visual indicator for surge protective devices (SPDs)
- Easy installation
- For installation into switchgear doors
- Low energy consumption due to current-saving LEDs
- Supplied by two AA batteries
- Easy battery replacement without opening the switchgear door
- Wire breakage detection by connecting the break contact of the remote signalling contact



Visual indicator for surge protective devices for installation into switchgear cabinets.

DEHNpanel remotely indicates the status of surge protective devices in a switchgear installation with remote signalling contact.

High-luminosity LEDs clearly indicate the status of the surge protective device even under difficult lighting conditions. DEHNpanel can be easily integrated into existing switchgear installations, allowing the operator of

the installation to easily test the surge protective devices installed without opening the switchgear cabinet.

The current-saving LEDs ensure a long battery service life of several years. Batteries can be replaced by ordinary persons since the switchgear cabinet does not have to be opened.

**DPAN L**

Visual indicator for surge protective devices for installation into switchgear cabinets.

Type	DPAN L
Part No.	910 200
Voltage supply	2x 1.5 V AA batteries
Operating state / fault indication	green LED (flashing) / red LED (flashing)
Flashing frequency	0.1 s on / 1.3 s off
Degree of protection (front / rear side)	IP 40 / IP 20
Mounting dimensions	92 x 45 mm
Dimensions	96 x 48 x 75 mm





Wiring Accessories DK



- Allows to change the wiring level
- For lightning-current-conform installation of arrester combinations

Uniform wiring level from the top by means of the DK 25 feed-through terminal.

**Feed-Through Terminal DK 25**

Feed-through terminal for busbar wiring.



Type	DK 25
Part No.	952 699
Nominal voltage (a.c. / d.c.) ( $U_N$ )	500 V
Nominal load current (a.c.) ( $I_N$ )	100 A
Lightning impulse current (10/350 $\mu$ s)	100 kA
Cross-sectional area (min.)	1.5 mm <sup>2</sup> solid / flexible
Cross-sectional area (max.)	25 mm <sup>2</sup> stranded / 16 mm <sup>2</sup> flexible



Wiring Accessories STAK

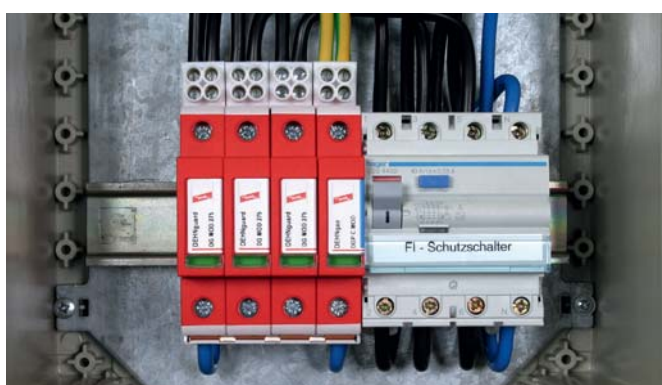

- EMC-optimised series connection according to IEC 60364-5-53

EMC-optimised series connection of lightning current and surge arresters according to IEC 60364-5-53 by means of STAK 2X16.

EMC-optimised series connection of string lines in a PV generator junction box by means of STAK 25.



**STAK 25 Pin-shaped Terminal**

Pin-shaped terminal for EMC-optimised series connection of lightning current and surge arresters according to IEC 60364-5-53.



Type STAK ...	25
Part No.	952 589
Nominal voltage (a.c. / d.c.) ( $U_N$ )	600 V
Max. PV voltage ( $U_{CPV}$ ) when used in combination with DEHNguard M YPV SCI ...	1200 V
Nominal load current (a.c.) ( $I_N$ )	100 A
Lightning impulse current (10/350 $\mu$ s)	25 kA
Discharge current (8/20 $\mu$ s)	50 kA
Cross-sectional area (min.)	1.5 mm <sup>2</sup> solid / flexible
Cross-sectional area (max.)	25 mm <sup>2</sup> stranded / 16 mm <sup>2</sup> flexible
Type of connection	front

**STAK 2X16 Pin-shaped Terminal**

Pin-shaped terminal for EMC-optimised series connection of lightning current and surge arresters according to IEC 60364-5-53.



Type STAK ...	2X16
Part No.	900 589
Lightning impulse current (10/350 $\mu$ s)	25 kA
Cross-sectional area (min.)	2x 1.5 mm <sup>2</sup>
Cross-sectional area (max.)	2x max. 16 mm <sup>2</sup>
Type of connection	front (double terminal)

Insulating Enclosures

- Lightning-impulse-current-tested insulating enclosure for arresters



Application example: Modular DEHNventil M TNS installed in an IGA 10 V2 IP54 insulating enclosure.

**IGA 10 V2 IP54**

Lightning-current-tested insulating enclosure with a max. capacity of ten modules; with grommet flange for 11 EPDM cables (Ø5-30 mm) and three mounted M20 grommet openings with lock nut; ideally suited for series connection.

Type IGA ...	<b>10 V2 IP54</b>
Part No.	<b>902 315</b>
Degree of protection	IP 54
Type	lightning-current-tested
Number of cable entries	4x for cables Ø5-7mm; 3x for cables Ø7-10 mm; 2x for cables Ø10-14 mm or Ø15-30 mm each; 3x for cables Ø8-13 mm
Capacity	10 modules, DIN 43880
Dimensions (W x H x D)	200 x 300 x 132 mm
Cover	sealable



**IGA 7 IP54**

Lightning-current-tested insulating enclosure with a max. capacity of seven modules; with EPDM grommet flange for two cables (Ø1-25 mm) and three mounted M20 grommet openings with lock nut; ideally suited for series connection.

Type IGA ...	<b>7 IP54</b>
Part No.	<b>902 314</b>
Degree of protection	IP 54
Type	lightning-current-tested
Number of cable entries	2x for cables Ø1-25 mm; 3x for cables Ø8-13 mm
Capacity	7 modules, DIN 43880
Dimensions (W x H x D)	175 x 250 x 100 mm
Cover	sealable



**IGA 6 IP54**

Lightning-current-tested insulating enclosure with a max. capacity of six modules for non-exhausting arresters; with knockouts for entering the cables and plug-in glands; ideally suited for series connection.

Type IGA ...	<b>6 IP54</b>
Part No.	<b>902 485</b>
Degree of protection	IP 54
Type	lightning-current-tested
Number of cable entries	2 plug-in glands for cables Ø8-23 mm (M32 knockout)
Capacity	6 modules, DIN 43880
Dimensions (W x H x D)	165 x 255 x 115 mm
Cover	sealable



**IGA 12 IP54**

Insulating enclosure with a max. capacity of 12 modules for non-exhausting arresters; with integrated elastic sealing grommet for entering the cables; ideally suited for series connection.



Type IGA ...	12 IP54
Part No.	902 471
Degree of protection	IP 54
Number of cable entries	8x for cables Ø7-12 mm; 8x for cables Ø7-14 mm; 4x for cables Ø12-20 mm; 1x for cables Ø16.5-29 mm (top and bottom)
PE / N quantity x cross-section	3x 25 mm <sup>2</sup> , 12x 4 mm <sup>2</sup> , Cu
Capacity	12 modules, DIN 43880
Dimensions (W x H x D)	295 x 333 x 129 mm

**IGA 12 IP65**

Lightning-current-tested insulating enclosure with a max. capacity of 12 modules for non-exhausting arresters; with integrated elastic sealing grommet for entering the cables; ideally suited for series connection.



Type IGA ...	12 IP65
Part No.	902 316
Degree of protection	IP 65
Type	lightning-current-tested
Number of cable entries	8x for cables Ø7-12 mm; 8x for cables Ø7-14 mm; 4x for cables Ø12-20 mm; 1x for cables Ø16.5-29 mm (top and bottom)
PE / N quantity x cross-section	3x 25 mm <sup>2</sup> , 12x 4 mm <sup>2</sup> , Cu
Capacity	12 modules, DIN 43880
Dimensions (W x H x D)	295 x 333 x 129 mm

**IGA 24 IP54**

Insulating enclosure with a max. capacity of 2x 12 modules for non-exhausting arresters; with integrated elastic sealing grommet for entering the cables; ideally suited for series connection.



Type IGA ...	24 IP54
Part No.	902 472
Degree of protection	IP 54
Number of cable entries	8x for cables Ø7-12 mm; 8x for cables Ø7-14 mm; 4x for cables Ø12-20 mm; 1x for cables Ø16.5-29 mm (top and bottom)
PE / N quantity x cross-section	6x 25 mm <sup>2</sup> , 24x 4 mm <sup>2</sup> , Cu
Capacity	24 modules (2x 12 modules), DIN 43880
Dimensions (W x H x D)	295 x 458 x 129 mm

**Accessories for Insulating Enclosure**

**Sealing Device**

For sealing between the lower and upper part of IGA 12 and IGA 24 insulating enclosures (doors can be sealed without additional part).



Type	PLOV IGA 12 24
Part No.	902 317
Material	aluminium

Busbars / Modular Wiring System

- Allows compact connection of arresters with each other and with other DIN rail mounted devices

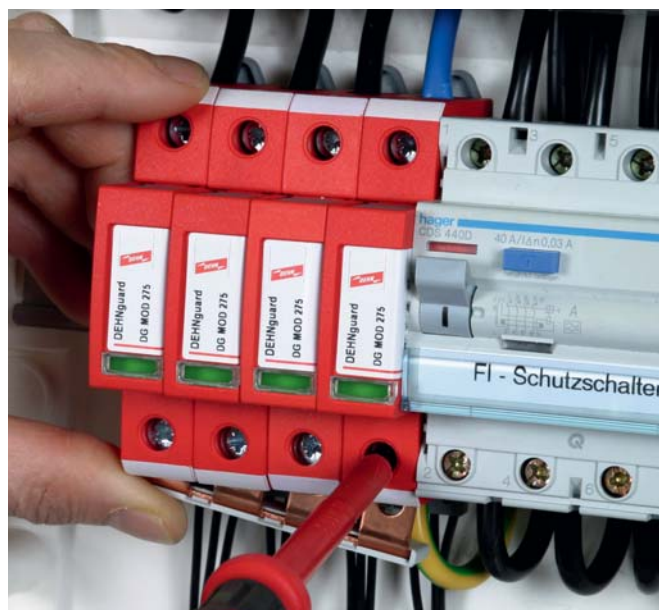
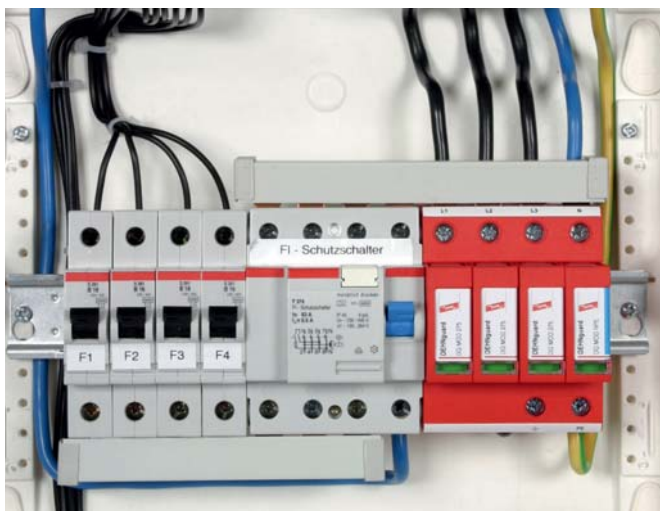

**MVS single-phase, two-pole**

For earth-side connection of e.g. 2 DEHGuard S surge arresters.

Type	MVS 1 2
Part No.	900 617
Type	single-phase
Number of contact studs	2
Max. installation length	2 module(s)
Nominal cross-section	16 mm <sup>2</sup>



**MVS single-phase, three-pole**

For earth-side connection of e.g. 3 DEHGuard S surge arresters.

Type	MVS 1 3
Part No.	900 615
Type	single-phase
Number of contact studs	3
Max. installation length	3 module(s)
Nominal cross-section	16 mm <sup>2</sup>



**MVS single-phase, four-pole**

For earth-side connection of e.g. 4 DEHGuard S surge arresters.

Type	MVS 1 4
Part No.	900 610
Type	single-phase
Number of contact studs	4
Max. installation length	4 module(s)
Nominal cross-section	16 mm <sup>2</sup>

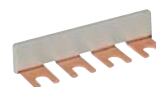

**MVS single-phase, six-pole**

For earth-side connection of e.g. 3 type 1 SPDs with two-module enclosure.

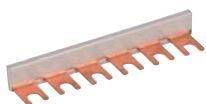

Type	<b>MVS 1 6</b>
Part No.	<b>900 815</b>
Type	single-phase
Number of contact studs	6
Max. installation length	6 module(s)
Nominal cross-section	16 mm <sup>2</sup>

**MVS single-phase, seven-pole**

For earth-side connection of e.g. 3 DEHNbloc Maxi and 1 DEHNgap Maxi in "3+1" circuits.

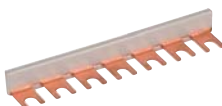

Type	<b>MVS 1 7</b>
Part No.	<b>900 848</b>
Type	single-phase
Number of contact studs	7
Max. installation length	7 module(s)
Nominal cross-section	16 mm <sup>2</sup>

**MVS single-phase, eight-pole**

For earth-side connection of e.g. 4 DEHNbloc Maxi lightning current arresters.

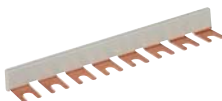

Type	<b>MVS 1 8</b>
Part No.	<b>900 611</b>
Type	single-phase
Number of contact studs	8
Max. installation length	8 module(s)
Nominal cross-section	16 mm <sup>2</sup>

**MVS single-phase, 57-pole**

For earth-side connection of lightning current and surge arresters or combinations thereof.

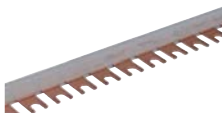

Type	<b>MVS 1 57</b>
Part No.	<b>900 612</b>
Type	single-phase
Number of contact studs	57
Max. installation length	57 module(s)
Nominal cross-section	16 mm <sup>2</sup>

**MVS three-phase, six-pole, 6 Modules**

For phase-side connection of surge arresters.



Type	<b>MVS 3 6 6</b>
Part No.	<b>900 595</b>
Type	three-phase
Number of contact studs	6
Max. installation length	6 module(s)
Nominal cross-section	16 mm <sup>2</sup>

**MVS three-phase, six-pole, 8 Modules**

For phase-side connection of DIN rail mounted devices to DEHNventil M TNC.

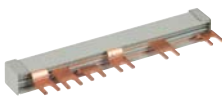

Type	<b>MVS 3 6 8</b>
Part No.	<b>900 813</b>
Type	three-phase
Number of contact studs	6
Max. installation length	8 module(s)
Nominal cross-section	16 mm <sup>2</sup>



### MVS three-phase, six-pole, 9 Modules

For phase-side connection of three-pole surge arresters to fuse holders (for 1.5-module enclosures).

Type	MVS 3 6 9
Part No.	900 839
Type	three-phase
Number of contact studs	6
Max. installation length	9 module(s)
Nominal cross-section	16 mm <sup>2</sup>



### MVS four-phase, eight-pole

For phase-side connection of DIN rail mounted devices to DEHNventil M TNS and TT.

Type	MVS 4 8 11
Part No.	900 814
Type	four-phase
Number of contact studs	8
Max. installation length	11 module(s)
Nominal cross-section	16 mm <sup>2</sup>

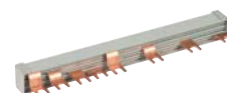

### MVS four-phase, 56-pole

For phase-side connection of surge arresters.

Type	MVS 4 56
Part No.	900 614
Type	four-phase
Number of contact studs	56
Max. installation length	56 module(s)
Nominal cross-section	16 mm <sup>2</sup>

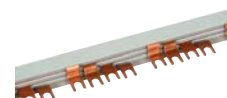

### Earthing Clip for 1.5-module Enclosures, single-phase, two-pole

Earthing clip for connecting the earth terminal of e.g. two SPDs with 1.5-module enclosure and terminal to earth.

Type	EB 1 2 1.5
Part No.	900 460
Type	single-phase
Number of contact studs	2
Dimensions	34 x 60 x 28 mm
Material	copper and tin-plated brass
Clamp	up to 25 mm <sup>2</sup>



### Earthing Clip for 1.5-module Enclosures, single-phase, three-pole

Earthing clip for connecting the earth terminal of e.g. three SPDs with 1.5-module enclosure and terminal to earth.

Type	EB 1 3 1.5
Part No.	900 418
Type	single-phase
Number of contact studs	3
Dimensions	34 x 85 x 28 mm
Material	copper and tin-plated brass
Clamp	up to 25 mm <sup>2</sup>



### Earthing Clip for 1.5-module Enclosures, single-phase, four-pole

Earthing clip for connecting the earth terminal of e.g. four SPDs with 1.5-module enclosure and terminal to earth.

Type	EB 1 4 1.5
Part No.	900 429
Type	single-phase
Number of contact studs	4
Dimensions	34 x 112 x 28 mm
Material	copper and tin-plated brass
Clamp	up to 25 mm <sup>2</sup>



**Earthing Clip for two-module Enclosures, single-phase, two-pole**

Earthing clip for connecting the earth terminal of e.g. two SPDs with two-module enclosure and terminal to earth.



Type	EB 1 2 5
Part No.	900 419
Type	single-phase
Number of contact studs	2
Dimensions	34 x 77 x 28 mm
Material	copper and tin-plated brass
Clamp	up to 25 mm <sup>2</sup>

**Earthing Clip for two-module Enclosures, single-phase, three-pole**

Earthing clip for connecting the earth terminal of e.g. three SPDs with two-module enclosure and terminal to earth.



Type	EB DG 1000 1 3
Part No.	900 411
Type	single-phase
Number of contact studs	3
Dimensions	34 x 112 x 28 mm
Material	copper and tin-plated brass
Clamp	up to 25 mm <sup>2</sup>

**Earthing Clip for two-module Enclosures, single-phase, four-pole**

Earthing clip for connecting the earth terminal of e.g. four SPDs with two-module enclosure and terminal to earth.



Type	EB 1 4 9
Part No.	900 417
Type	single-phase
Number of contact studs	4
Dimensions	34 x 148 x 28 mm
Material	copper and tin-plated brass
Clamp	up to 25 mm <sup>2</sup>

**Earthing Clip for three-module Enclosures, single-phase, three-pole**

Earthing clip for connecting the earth terminal of e.g. three SPDs with three-module enclosure and terminal to earth.



Type	EB 1 3 10
Part No.	900 461 <sup>NEW</sup>
Type	single-phase
Number of contact studs	3
Dimensions	34 x 158 x 28 mm
Material	copper and tin-plated brass
Clamp	up to 25 mm <sup>2</sup>

**Earthing Clip for three-module Enclosures, single-phase, four-pole**

Earthing clip for connecting the earth terminal of e.g. four SPDs with three-module enclosure and terminal to earth.



Type	EB 1 4 13
Part No.	900 462 <sup>NEW</sup>
Type	single-phase
Number of contact studs	4
Dimensions	34 x 212 x 28 mm
Material	copper and tin-plated brass
Clamp	up to 25 mm <sup>2</sup>



## Impulse Counter

### Registration of discharge processes

- Potential-free registration of discharge currents occurred in surge protective devices
- Easy installation by enclosing the earthing conductor of the arrester with a hinged toroidal core
- Counter in a DIN rail mounted enclosure (2 modules)
- Twisted sensor cable, 1 m long

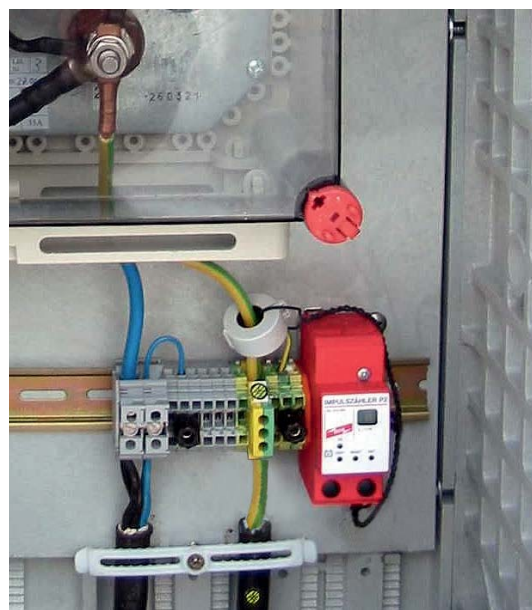

P2 impulse counter: Counter, sensor cable and toroidal core with fixing accessory

Counter with integrated battery supply (9 V) and battery charge control. Indication via two-digit LCD display with setting and re-setting buttons.

### P 2 Impulse Counter

Type	P 2
Part No.	910 502
Response threshold for impulse currents (rise time $\geq 8 \mu\text{s}$ )	> 1 kA
LCD display	electronic counter 0-99
Power supply	9 V battery (IEC 6LR61) included in delivery, replaceable, battery life > 1 year
Setting device	button on the device for setting the counter (e.g. after replacing a battery)
Resetting device	button on the device for resetting the counter to 0
Dimensions (sensor)	inner $\varnothing 15 \text{ mm}$ , outer $\varnothing 36 \text{ mm}$
Accessories included in delivery	9 V battery, IEC 6LR61; cable tie (for fixing the sensor)





SPD Test Device



- For routine tests of surge protective devices
- Compact dimensions
- Suitable for mains and battery operation
- Low battery indicator
- Test leads included in delivery

For testing the sparkover voltage of surge arresters. The specimen is connected via the included test leads or special test adapters.

The PM 20 SPD test device with integrated sparkover detection is used to test Red/Line and Yellow/Line surge arresters with integrated varistor, Zener diode or gas discharge tube. Both the sparkover performance between the connections of the arresters as well as the continuity can be

tested. The results can be compared to the limit values specified in the instructions for use. In case of deviations, the arrester or protection module must be replaced. Test adapters for testing Yellow /Line products can be found on page 219.



Indication of the measured spark-over voltage.



The sparkover characteristics of gas discharge tubes, varistors and Zener diodes can be tested.



Insulated test leads included in delivery.



Can be directly connected to a DEHNguard protection module.

**PM 20**

Combined device for testing the sparkover voltage of surge arresters (with gas discharge tubes/varistors/Zener diodes). Storage bag and measuring accessories included.



Type	PM 20
Part No.	910 511
Nominal voltage (U <sub>N</sub> )	8-12 V d.c.
Test parameter: Test voltage	max. 1250 V d.c.
Test parameter: Test current (reference voltage)	1 mA d.c., constant
Measured value indication	alphanumeric, eight-digit LCD
Accessories included in delivery	2 test leads (each 1 m long), 2 safety tapping test clips, 1 plug-in power supply unit (230 V a.c.), 1 storage bag

# Surge Protection for INFORMATION TECHNOLOGY SYSTEMS

SPDs for Installations and Devices



**Yellow / Line**

## SPDs for Information Technology Systems



Category	Type of test	Impulse voltage	Impulse current	Minimum quantity of impulses	Test for
C1	fast rate of rise	0.5 kV to 2 kV, 1.2/50 $\mu$ s	0.25 kA to 1 kA, 8/20 $\mu$ s	300	Surge arrester
C2		2 kV to 10 kV, 1.2/50 $\mu$ s	1 kA to 5 kA, 8/20 $\mu$ s	10	
C3		$\geq 1$ kV, 1 kV/ $\mu$ s	10 A to 100 A, 10/1000 $\mu$ s	300	
D1	high energy	$\geq 1$ kV	0.5 kA to 2.5 kA, 10/350 $\mu$ s	2	*)

\*) Lightning current arrester / Combined lightning current and surge arrester

Impulse voltages and currents (preferred values) for determining the voltage-limiting characteristics (excerpt from Table 3 of IEC / EN 61643-21)

The surge protection components of arresters do not contain any radioactive isotopes and typically consist of at least one voltage-limiting or voltage-switching component and, in some cases, also of additional overcurrent-limiting components. The occurrence of blind spots in multistage arresters must be prevented. This means that it must be ensured that the different protection stages are fully coordinated with one another. Otherwise the protection stages will not reliably trip and cause faults in the protective device.

#### Arrester selection

The following must be observed when selecting arresters:

- Protective effect [Yellow/Line SPD class (discharge capacity and voltage protection level)]
- System parameters (system voltage, nominal current and transmission parameters)
- Installations environment (design, connection conditions and approvals)

The selection guide according to interface/signal on pages 121 – 140 facilitates the selection of an adequate arrester.

#### Relevant product standard for arresters:

IEC / EN 61643-21

Low-voltage surge protective devices – Part 21: Surge protective devices connected to telecommunications and signalling networks – Performance requirements and testing methods.

#### Discharge capacity

According to IEC / EN 61643-21 arresters must be tested with at least one impulse voltage and impulse current from the above table with the specified quantity of impulses. Further tests may be performed – even with different impulse values or quantities. The max. voltage level measured during the test(s) at the output of the device is specified as voltage protection level  $U_p$ . Category C represents particularly interference pulses with a steep rate of rise and low energy, while interference pulses of category D are supposed to simulate high energy loads caused by injected partial lightning currents. The relevant category is specified in the technical data of the arresters [see discharge capacity ( $I_n$ ,  $I_{imp}$ ) and voltage protection level ( $U_p$ )].

#### Immunity of terminal equipment to be protected

During electromagnetic compatibility (EMC) tests, electrical and electronic equipment (devices) must have a certain immunity to conducted interferences (surges). The requirements on the immunity and the test set-up are described in IEC / EN 61000-4-5.

Since the devices are used in different electromagnetic environments, they must have different immunities. The immunity of a device depends on the test level. To classify the different immunities of terminal equipment, test levels are subdivided into four different levels (1 to 4). Test level 1 places the lowest requirement on the immunity of terminal equipment. The test level is specified in the arrester documentation or can be requested from the manufacturer of the arrester.

Test levels 1 – 4 according to EN 61000-4-5	Corresponds to the charging voltage of the test generator
1	0.5 kV
2	1 kV
3	2 kV
4	4 kV

#### Protective effect of arresters

Yellow / Line arresters for use in information technology systems are capable of limiting conducted interference to a safe level so that the immunity of the terminal equipment is not exceeded. For example, an arrester with a let-through value below the EMC test values of the terminal device must be selected for a terminal device tested with test level 2: Impulse voltage  $< 1$  kV in combination with an impulse current of some amperes (depending on the coupling network).



**General**

116

Auswahlhilfe nach...

Systeme und MSB-Technik	Montage	Tr.	Anschlusstechnik	protektionsklasse	Ex
Schalttafel / Signal	—	—	Schraubklemmen	4	☐
BACnet MS/TP	—	—	Schraubklemmen	2	☐
	—	—	Schraubklemmen	4	☐
	—	—	Schraubklemmen	2	☐
	—	—	Federklemmen	2	☐
—	—	—	USA	20	☐
—	—	—	Schraubklemmen	4	☐
—	—	—	Schraubklemmen	2	☐
—	—	—	Schraubklemmen	4	☐

**Easy Choice according to Interface / Signal**

121



**Pluggable SPDs – DIN Rail mounted**  
BLITZDUCTOR XT/XTU/SP

141



**Terminal Block SPDs – DIN Rail mounted**  
DEHNconnect SD2

163



**Compact SPDs – DIN Rail mounted**  
DEHNvario, BLITZDUCTOR VT

167

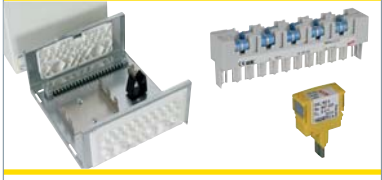

**SPDs for LSA Technology**  
DEHNrapid LSA

173



**SPDs for Field Devices**  
DEHNpipe

183



**SPDs for Telecommunication and Data Networks**  
DEHNpatch, NET PRO

189



**SPDs for Building Systems**  
DEHNprotector, DEHNbox, BUSsector, DEHNlink

193



**SPDs for Coaxial Transmitters / Receivers and Video Systems**  
UGKF, DEHNgate

201



**SPDs for SUB-D Connection**  
FS, USD

207



**Shield Connection Systems and Enclosures**

209



**Measuring and Test Devices**  
DEHNrecord

215

117

**Yellow/Line SPD Classes – Symbols**

All SPDs of the Yellow/Line family for use in information technology systems are assigned to a Yellow/Line SPD class and marked with a symbol in the technical data sheet and on their rating plates. The symbol for the Yellow/Line SPD class graphically combines three important characteristics of the SPD and can be a single symbol or a combination of individual symbols:

Characteristics	Single symbol	Definition
Discharge capacity of an SPD (according to the categories from IEC 61643-21 / EN 61643-21)	TYPE 1	Impulse D1 (10/350), lightning impulse current $\geq 2.5$ kA/line or $\geq 5$ kA/total • exceeds the discharge capacity of TYPE 2 – TYPE 4
	TYPE 2	Impulse C2 (8/20), increased impulse load $\geq 2.5$ kA/line or $\geq 5$ kA/total • exceeds the discharge capacity of TYPE 3 – TYPE 4
	TYPE 3	Impulse C1 (8/20), impulse load $\geq 0.25$ kA/line or $\geq 0.5$ kA/total • exceeds the discharge capacity of TYPE 4
	TYPE 4	Load < TYPE 3
Protective effect of an SPD (limitation below the test levels according to EN 61000-4-5)	P1	Required test level of the terminal device: 1 or higher
	P2	Required test level of the terminal device: 2 or higher
	P3	Required test level of the terminal device: 3 or higher
	P4	Required test level of the terminal device: 4
Energy coordination (with another Yellow/Line SPD)	+	SPD with decoupling impedance, suitable for coordination with an SPD marked with □
	□	SPD is suitable for coordination with an SPD with decoupling impedance +

**Examples of energy-coordinated SPDs according to the Yellow/Line SPD class:**

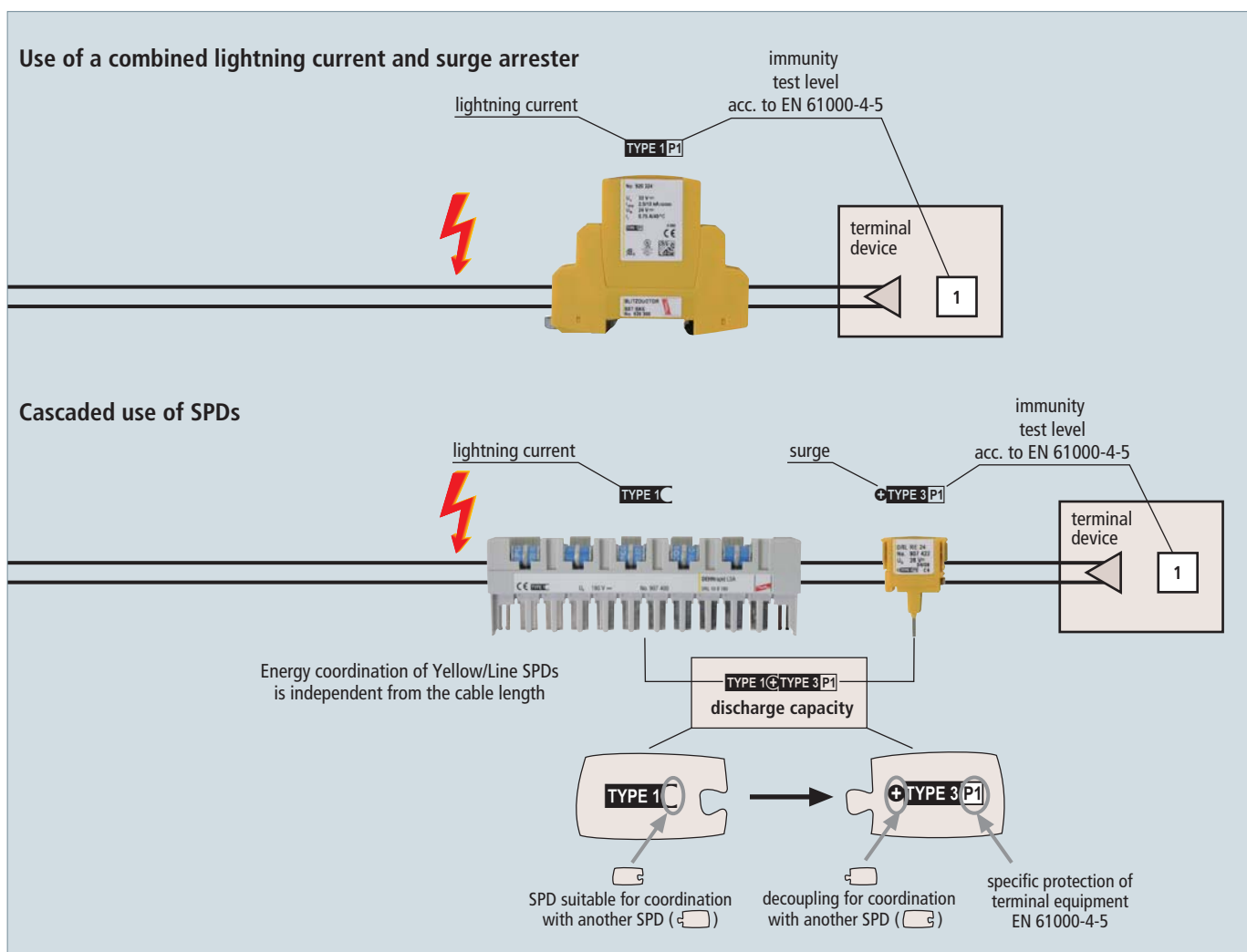



LifeCheck® SPD Test



Testing a protection module via a hand-held device based on RFID technology (LifeCheck).

**SPD diagnostics with early warning function!**

- Increased protection and availability of your installations and systems due to integrated LifeCheck monitoring system
  - Integrated three-stage monitoring of all protective circuit components
  - Quick diagnostics of surge protective devices
  - Easy testing of protection modules without downtime via contactless RFID technology
  - Even detects pre-damaged arresters

**Regular testing of arresters installed**

During operation, an arrester may be overloaded by discharge processes exceeding the arrester specification. In order to ensure high system availability, it is therefore essential to test arresters on a regular basis. DIN EN 62305-3, supplement 3 (see table excerpt), specifies the maximum intervals between tests of external and internal lightning protection systems.

Class of LPS	Visual inspection	Complete inspection	Complete inspection of critical systems
I and II	1 year	2 years	1 year
III and IV	2 years	4 years	1 year

**Easy testing with LifeCheck**

Maintenance of LifeCheck-equipped BLITZDUCTOR XT arresters is particularly easy. LifeCheck uses modern RFID (Radio Frequency Identification) technology for monitoring the protective circuit and for communication. Irrespective of system downtimes, LifeCheck allows quick and easy testing of arresters by means of the hand-held DRC LC M1+ and DRC LC M3+ reader or a stationary DRC SCM XT and DRC MCM XT condition monitoring unit.

**Indication of arrester failure**

The three-stage LifeCheck monitoring circuit with early warning function detects extreme electrical or thermal stress on all protection elements of an arrester below their destruction limit. This can be contactlessly read out within a matter of seconds by means of an RFID reader. If the reader displays "LifeCheck OK", no extreme stress was detected. If the contrary is the case, the module should be replaced as soon as possible in order not to threaten the availability of the protected circuit.

**Functional principle of the LifeCheck diagnostics systems**

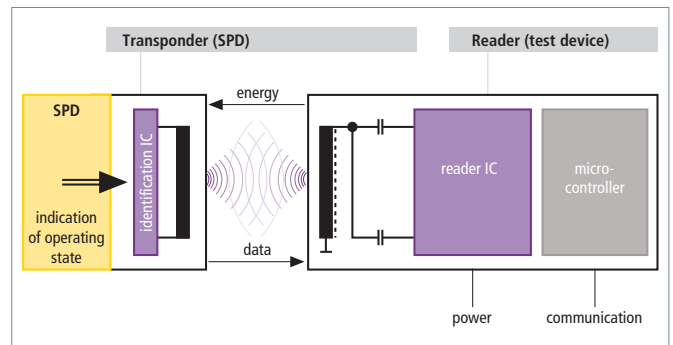

Principle of communication between an arrester and a test device

The diagnostics system consists of two functional units:

**1. RFID reading and signalling unit (reader)**

Combined with a visual or electric indicator, an electronic system contactlessly transmits energy to the RFID transponder in the arrester via an antenna. If the operating state of the arrester can be read out, an "OK" message is displayed.

**2. Monitoring unit in the arrester:**

It combines the diagnostics of the three-stage LifeCheck monitoring circuit with the communication of the RFID transponder:

- Diagnostics of electrical overload (impulse current)  
Lightning strikes or overvoltage exceeding the specified discharge capacity of the arrester will damage or even destroy the protection elements. The LifeCheck monitoring device detects this electrical overload. When reading out the transponder, the "Replace SPD!" message appears.
- Diagnostics of thermal overload (overheating)  
Active and passive protection elements in a critical temperature range will be pre-damaged or even destroyed depending on the type and duration of the overload. This pre-damage or overload is detected by the LifeCheck monitoring device. When reading out the transponder, the "Replace SPD!" message appears.

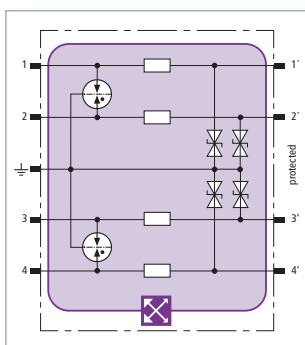

The basic circuit diagram graphically shows whether LifeCheck is used to monitor the protective circuit of an arrester. In case of BXT arresters, the complete protective circuit is monitored.

# Yellow/Line Selection Guide



Bus systems and measuring and control equipment

Page 121 – 131

Telecommunications, telephone systems

Page 132 – 135

Data networks





































































Page 136 – 137

Antenna systems, broadband systems, transmitting and receiving systems, video systems

Page 138 – 140

This selection chart is only intended for orientation. In practice, there may be other interface parameters. Therefore, we recommend to check whether the electrical parameters are suited for the interface to be protected before using the arrester.

















































































Easy Choice

Bus systems and measuring and control equipment									
Interface / Signal	For mounting on	Ex	Connection system	Protected lines	LifeCheck	SPD class TYPE	SPD	Part No.	Page
0-20 mA, 4-20 mA (also with HART)			Screw terminals	4	●	<b>1</b>		920 324 <sup>1)</sup>	144
			Screw terminals	2	●	<b>1</b>		920 224 <sup>1)</sup>	147
			Screw terminals	4		<b>2</b>		926 324 <sup>1)</sup>	152
			Screw terminals	2		<b>2</b>		926 224 <sup>1)</sup>	153
			Spring terminals	2		<b>2</b>		917 921	164
			Spring terminals	2		<b>3</b>		917 988	164
			Wires / terminals	2		<b>2</b>		929 921	185
			LSA	20		<b>1</b>		907 401 + 907 422 + 907 498	175 177
4-20 mA (also with HART) acc. to NAMUR recommendation NE 21 or according to EN 61000-4-5, open-circuit voltage 1 kV line-PG 			Screw terminals	4	●	<b>1</b>		920 344 <sup>1)</sup>	144
			Screw terminals	2	●	<b>1</b>		920 244 <sup>1)</sup>	146
			Screw terminals	4		<b>2</b>		926 344 <sup>1)</sup>	152
			Screw terminals	2		<b>2</b>		926 244 <sup>1)</sup>	153
			Spring terminals	2		<b>2</b>		917 941	164
			Screw terminals	4		<b>2</b>		918 407	169
			Wires / terminals	2		<b>2</b>		929 941	184
			LSA	20		<b>1</b>		907 401 + 907 442 + 907 498	175 177
3/4 conductor measurement			Screw terminals	4	●	<b>1</b>		920 350 <sup>1)</sup>	145
			Screw terminals	4	●	<b>1</b>		920 354 <sup>1)</sup>	145
ADVANT			Screw terminals	4	●	<b>1</b>		920 370 <sup>1)</sup>	145
			Screw terminals	2	●	<b>1</b>		920 270 <sup>1)</sup>	147
			Screw terminals	4		<b>2</b>		926 370 <sup>1)</sup>	152
			Screw terminals	2		<b>2</b>		926 270 <sup>1)</sup>	154
			Screw terminals	5		<b>2</b>		918 401	169
			Spring terminals	2		<b>2</b>		917 970	164
AS interface			Screw terminals	4	●	<b>1</b>		920 345 <sup>1)</sup>	144
			Screw terminals	2	●	<b>1</b>		920 245 <sup>1)</sup>	146
			Screw terminals	4		<b>2</b>		926 345 <sup>1)</sup>	152
			Screw terminals	2		<b>2</b>		926 245 <sup>1)</sup>	153
BACnet/IP			RJ45	4 x 2		<b>2</b>		929 100	190
			RJ45	4 x 2		<b>2</b>		929 121	190
			RJ45	4 x 2		<b>2</b>		929 126	190
			RJ45, LSA	8 x 8		<b>3</b>		929 035 / 036	191
			RJ45	8 x 8		<b>4</b>		929 037	191
			RJ45	4		<b>2</b>		909 321	195

<sup>1)</sup> with universal base part BXT BAS (Part No. 920 300) or BSP BAS 4 (Part No. 926 304) please refer to page 142

<sup>2)</sup> with universal base part BXT BAS EX (Part No. 920 301) please refer to page 156













































































Bus systems and measuring and control equipment

Interface / Signal	For mounting on	Ex	Connection system	Protected lines	LifeCheck 	SPD class TYPE	SPD 	Part No.	Page
<b>BACnet MS/TP</b>  			Screw terminals	4	●	<b>1</b>		920 371 <sup>1)</sup>	146
			Screw terminals	2	●	<b>1</b>		920 271 <sup>1)</sup>	147
			Screw terminals	4		<b>2</b>		926 371 <sup>1)</sup>	153
			Screw terminals	2		<b>2</b>		926 271 <sup>1)</sup>	154
			Spring terminals	2		<b>2</b>		917 970	164
			LSA	20		<b>1</b>		907 401 +907 465 +907 498	175 177
<b>Binary signals</b>			Screw terminals	4	●	<b>1</b>		920 320 – 327 <sup>1)</sup>	144
			Screw terminals	2	●	<b>1</b>		920 220 – 225 <sup>1)</sup>	147
			Screw terminals	4		<b>2</b>		926 320 – 327 <sup>1)</sup>	152
			Screw terminals	2		<b>2</b>		926 220 – 225 <sup>1)</sup>	153
			Spring terminals	2		<b>2</b>		917 920 – 922	164
			Spring terminals	2		<b>3</b>		917 987 – 989	164
			LSA	20		<b>1</b>		907 401 +907 422 +907 498	179 177
<b>Bitbus</b>			Screw terminals	4	●	<b>1</b>		920 370 <sup>1)</sup>	145
			Screw terminals	2	●	<b>1</b>		920 270 <sup>1)</sup>	147
			Screw terminals	4		<b>2</b>		926 370 <sup>1)</sup>	152
			Screw terminals	2		<b>2</b>		926 270 <sup>1)</sup>	154
			Spring terminals	2		<b>2</b>		917 970	164
<b>BLN</b> (Building Level Network)			Screw terminals	4	●	<b>1</b>		920 342 <sup>1)</sup>	144
			Screw terminals	2	●	<b>1</b>		920 242 <sup>1)</sup>	146
			Screw terminals	4	●	<b>1</b>		920 345 <sup>1)</sup>	144
			Screw terminals	2	●	<b>1</b>		920 245 <sup>1)</sup>	146
			Screw terminals	4		<b>2</b>		926 342 <sup>1)</sup>	152
			Screw terminals	2		<b>2</b>		926 242 <sup>1)</sup>	153
			Screw terminals	4		<b>2</b>		926 345 <sup>1)</sup>	152
			Screw terminals	2		<b>2</b>		926 245 <sup>1)</sup>	153
<b>CAN bus</b> (data line only)			Screw terminals	4	●	<b>1</b>		920 371 <sup>1)</sup>	146
			Screw terminals	2	●	<b>1</b>		920 271 <sup>1)</sup>	147
			Screw terminals	4		<b>2</b>		926 371 <sup>1)</sup>	153
			Screw terminals	2		<b>2</b>		926 271 <sup>1)</sup>	154
			Spring terminals	2		<b>2</b>		917 970	164
			LSA	20		<b>1</b>		907 401 +907 465 +907 498	175 177
<b>C bus</b> (Honeywell)			Screw terminals	4	●	<b>1</b>		920 371 <sup>1)</sup>	146
			Screw terminals	2	●	<b>1</b>		920 271 <sup>1)</sup>	147
			Screw terminals	4		<b>2</b>		926 371 <sup>1)</sup>	153
			Screw terminals	2		<b>2</b>		926 271 <sup>1)</sup>	154
			Spring terminals	2		<b>2</b>		917 970	164
<b>CCP systems</b> <b>Sensor circuit</b>			Screw terminals	2		<b>1</b>		918 421	171
			Screw terminals	2		<b>1</b>		918 420	171

<sup>1)</sup> with universal base part BXT BAS (Part No. 920 300) or BSP BAS 4 (Part No. 926 304) please refer to page 142









































































































<sup>2)</sup> with universal base part BXT BAS EX (Part No. 920 301) please refer to page 156

Bus systems and measuring and control equipment

Interface / Signal	For mounting on	Ex	Connection system	Protected lines	LifeCheck	SPD class TYPE	SPD	Part No.	Page
Control Net			BNC	1		<b>2</b>		929 010	202
			BNC	1		<b>2</b>		909 710 / 711	204
DALI Bus			Screw terminals	2	●	<b>1</b>		920 244 <sup>1)</sup>	146
			Screw terminals	2		<b>2</b>		926 244 <sup>1)</sup>	153
Data Highway Plus 			Screw terminals	4	●	<b>1</b>		920 342 <sup>1)</sup>	144
			Screw terminals	2	●	<b>1</b>		920 242 <sup>1)</sup>	146
			Screw terminals	4		<b>2</b>		926 342 <sup>1)</sup>	152
			Screw terminals	2		<b>2</b>		926 242 <sup>1)</sup>	153
			Spring terminals	2		<b>2</b>		917 940	164
d.c. power supply up to 60 V d.c.			Screw terminals	2		<b>3</b>		918 422	169
			Screw terminals	2		<b>1</b>		918 408	170
			Screw terminals	2		<b>1</b>		918 409	170
Delta Net Peer Bus			Screw terminals	4	●	<b>1</b>		920 370 <sup>1)</sup>	145
			Screw terminals	2	●	<b>1</b>		920 270 <sup>1)</sup>	147
			Screw terminals	4		<b>2</b>		926 370 <sup>1)</sup>	152
			Screw terminals	2		<b>2</b>		926 270 <sup>1)</sup>	154
			Spring terminals	2		<b>2</b>		917 970	164
Device Net (data line only) 			Screw terminals	4	●	<b>1</b>		920 371 <sup>1)</sup>	146
			Screw terminals	2	●	<b>1</b>		920 271 <sup>1)</sup>	147
			Screw terminals	4		<b>2</b>		926 371 <sup>1)</sup>	153
			Screw terminals	2		<b>2</b>		926 271 <sup>1)</sup>	154
			Spring terminals	2		<b>2</b>		917 970	164
DMX bus (lightning technology) 			Screw terminals	4	●	<b>1</b>		920 371 <sup>1)</sup>	146
			Screw terminals	2	●	<b>1</b>		920 271 <sup>1)</sup>	147
			Screw terminals	4		<b>2</b>		926 371 <sup>1)</sup>	153
			Screw terminals	2		<b>2</b>		926 271 <sup>1)</sup>	154
			Spring terminals	2		<b>2</b>		917 970	164
Dupline 			Screw terminals	4	●	<b>1</b>		920 243 <sup>1)</sup>	148
E bus (Honeywell) 			Screw terminals	4	●	<b>1</b>		920 345 <sup>1)</sup>	144
			Screw terminals	2	●	<b>1</b>		920 245 <sup>1)</sup>	146
			Screw terminals	4		<b>2</b>		926 345 <sup>1)</sup>	152
			Screw terminals	2		<b>2</b>		926 245 <sup>1)</sup>	153
EIB			Screw terminals	4	●	<b>1</b>		920 310 <sup>1)</sup>	144
			Screw terminals	2	●	<b>1</b>		920 211 <sup>1)</sup>	148
			Wires	2		<b>2</b>		925 001	196
			LSA	20		<b>1</b>		907 401	175

<sup>1)</sup> with universal base part BXT BAS (Part No. 920 300) or BSP BAS 4 (Part No. 926 304) please refer to page 142  
<sup>2)</sup> with universal base part BXT BAS EX (Part No. 920 301) please refer to page 156

Bus systems and measuring and control equipment

Interface / Signal	For mounting on	Ex	Connection system	Protected lines	LifeCheck 	SPD class TYPE	SPD 	Part No.	Page
Electroacoustic system			Screw terminals	4	●	<b>1</b>		920 347 <sup>1)</sup>	144
			Screw terminals	4		<b>2</b>		926 347 <sup>1)</sup>	152
			Spring terminals	2		<b>1</b>		928 430	167
			LSA	20		<b>1</b>		907 401 + 907 445 + 907 498	175 177
ET 200			Screw terminals	4	●	<b>1</b>		920 370 <sup>1)</sup>	145
			Screw terminals	2	●	<b>1</b>		920 270 <sup>1)</sup>	147
			Screw terminals	4		<b>2</b>		926 370 <sup>1)</sup>	152
			Screw terminals	2		<b>2</b>		926 270 <sup>1)</sup>	154
			Spring terminals	2		<b>2</b>		917 970	164
Ex(d) circuits 4-20 mA, NAMUR, HART, PROFIBUS-PA, F			Wires	2		<b>2</b>		929 962 / 964	185
			Wires	4		<b>2</b>		929 950 / 951	186
			Wires	4		<b>2</b>		929 952 / 953	186
Ex (i) circuits			Screw terminals	4	●	<b>2</b>		920 381 <sup>2)</sup>	156
			Screw terminals	4	●	<b>2</b>		920 538 <sup>2)</sup>	157
			Screw terminals	2	●	<b>2</b>		920 280 <sup>2)</sup>	156
			Screw terminals	2		<b>2</b>		920 383 <sup>2)</sup>	157
			Spring terminals	2		<b>2</b>		917 960	165
			Wires / terminals	2		<b>2</b>		929 960	185
			Wires	2		<b>2</b>		929 961 / 963	185
			Wires	4		<b>2</b>		929 950 / 951	186
			Wires	4		<b>2</b>		929 952 / 953	186
			Screw terminals	4	●	<b>2</b>		989 408	158
Fieldbus Foundation 			Screw terminals	4	●	<b>1</b>		920 344 <sup>1)</sup>	144
			Screw terminals	2	●	<b>1</b>		920 244 <sup>1)</sup>	146
			Screw terminals	4		<b>2</b>		926 344 <sup>1)</sup>	152
			Screw terminals	2		<b>2</b>		926 244 <sup>1)</sup>	153
			Spring terminals	2		<b>2</b>		917 941	164
			Wires / terminals	2		<b>2</b>		929 941	184
			LSA	20		<b>1</b>		907 401 + 907 442 + 907 498	175 177
	Fieldbus Foundation Ex (i)			Screw terminals	4	●	<b>2</b>		920 381 <sup>2)</sup>
			Screw terminals	4	●	<b>2</b>		920 538 <sup>2)</sup>	157
			Screw terminals	2	●	<b>2</b>		920 280 <sup>2)</sup>	156
			Screw terminals	2		<b>2</b>		920 383 <sup>2)</sup>	157
			Spring terminals	2		<b>2</b>		917 960	165
			Wires / terminals	2		<b>2</b>		929 960	185
			Wires	2		<b>2</b>		929 961 / 963	185
			Wires	2		<b>2</b>		929 971	186
			Wires	4		<b>2</b>		929 950 / 951	186
			Screw terminals	4	●	<b>2</b>		989 408	158

















































































<sup>1)</sup> with universal base part BXT BAS (Part No. 920 300) or BSP BAS 4 (Part No. 926 304) please refer to page 142  
<sup>2)</sup> with universal base part BXT BAS EX (Part No. 920 301) please refer to page 156

Bus systems and measuring and control equipment

Interface / Signal	For mounting on	Ex	Connection system	Protected lines	LifeCheck	SPD class TYPE	SPD	Part No.	Page
FIPIO/FIPWAY			Screw terminals	4	●	<b>1</b>		920 344 <sup>1)</sup>	144
			Screw terminals	2	●	<b>1</b>		920 244 <sup>1)</sup>	146
			Screw terminals	4		<b>2</b>		926 344 <sup>1)</sup>	152
			Screw terminals	2		<b>2</b>		926 244 <sup>1)</sup>	153
FIP I/O			Screw terminals	4	●	<b>1</b>		920 370 <sup>1)</sup>	145
			Screw terminals	2	●	<b>1</b>		920 270 <sup>1)</sup>	147
			Screw terminals	4		<b>2</b>		926 370 <sup>1)</sup>	152
			Screw terminals	2		<b>2</b>		926 270 <sup>1)</sup>	154
FSK			Screw terminals	4	●	<b>1</b>		920 371 <sup>1)</sup>	146
			Screw terminals	2	●	<b>1</b>		920 271 <sup>1)</sup>	147
			Screw terminals	4		<b>2</b>		926 371 <sup>1)</sup>	153
			Screw terminals	2		<b>2</b>		926 271 <sup>1)</sup>	154
			Spring terminals	2		<b>2</b>		917 970	164
Genius I/O bus			Screw terminals	4	●	<b>1</b>		920 342 <sup>1)</sup>	144
			Screw terminals	2	●	<b>1</b>		920 242 <sup>1)</sup>	146
			Screw terminals	4		<b>2</b>		926 342 <sup>1)</sup>	152
			Screw terminals	2		<b>2</b>		926 242 <sup>1)</sup>	153
IEC bus (RS485)			Screw terminals	4	●	<b>1</b>		920 371 <sup>1)</sup>	146
			Screw terminals	2	●	<b>1</b>		920 271 <sup>1)</sup>	147
			Screw terminals	4		<b>2</b>		926 371 <sup>1)</sup>	153
			Screw terminals	2		<b>2</b>		926 271 <sup>1)</sup>	154
			Spring terminals	2		<b>2</b>		917 970	164
Industrial Ethernet			LSA	20		<b>1</b>		907 401 + 907 470 + 907 498	175 177
			RJ45	4 x 2		<b>2</b>		929 100	190
			RJ45	4 x 2		<b>2</b>		929 121	190
			RJ45	4 x 2		<b>2</b>		929 126	190
			RJ45, LSA / RJ45	8 x 8		<b>3</b>		929 035 / 036	191
			RJ45	8 x 8		<b>4</b>		929 037	191
			RJ45	4		<b>2</b>		909 321	195
INTERBUS-INLINE (I/O)			Screw terminals	4	●	<b>1</b>		920 345 <sup>1)</sup>	144
			Screw terminals	4	●	<b>1</b>		920 325 <sup>1)</sup>	144
			Screw terminals	4		<b>2</b>		926 345 <sup>1)</sup>	152
			Screw terminals	4		<b>2</b>		926 325 <sup>1)</sup>	152
INTERBUS-Loop			Spring terminals	2		<b>3</b>		917 988	164
Interbus INLINE remote bus			Screw terminals	4	●	<b>1</b>		920 371 <sup>1)</sup>	146
			Screw terminals	2	●	<b>1</b>		920 271 <sup>1)</sup>	147
			Screw terminals	4		<b>2</b>		926 371 <sup>1)</sup>	153
			Screw terminals	2		<b>2</b>		926 271 <sup>1)</sup>	154
			Screw terminals	5		<b>2</b>		918 401	169

<sup>1)</sup> with universal base part BXT BAS (Part No. 920 300) or BSP BAS 4 (Part No. 926 304) please refer to page 142  
<sup>2)</sup> with universal base part BXT BAS EX (Part No. 920 301) please refer to page 156





































































Bus systems and measuring and control equipment

Interface / Signal	For mounting on	Ex	Connection system	Protected lines	LifeCheck 	SPD class TYPE	SPD 	Part No.	Page
<b>K bus</b>			Screw terminals	4	●	<b>1</b>		920 344 <sup>1)</sup>	144
			Screw terminals	2	●	<b>1</b>		920 244 <sup>1)</sup>	146
			Screw terminals	4		<b>2</b>		926 344 <sup>1)</sup>	152
			Screw terminals	2		<b>2</b>		926 244 <sup>1)</sup>	153
			Spring terminals	2		<b>2</b>		917 941	164
<b>KBR energy bus</b>			Screw terminals	4	●	<b>1</b>		920 370 <sup>1)</sup>	145
			Screw terminals	2	●	<b>1</b>		920 270 <sup>1)</sup>	147
			Screw terminals	4		<b>2</b>		926 370 <sup>1)</sup>	152
			Screw terminals	2		<b>2</b>		926 270 <sup>1)</sup>	154
			Spring terminals	2		<b>2</b>		917 970	164
<b>KNX bus</b>			Screw terminals	4	●	<b>1</b>		920 310 <sup>1)</sup>	144
			Screw terminals	2	●	<b>1</b>		920 211 <sup>1)</sup>	148
			Wires	2		<b>2</b>		925 001	196
			LSA	20		<b>1</b>		907 401	175
<b>LON</b> – TP/XF 78  – TP/FTT10 (up to 1 A) and TP/LPT10 (up to 1 A)  (up to 1.7 A)  (up to 0.4 A)  – TP/FTT 10			Screw terminals	4	●	<b>1</b>		920 340 <sup>1)</sup>	144
			Screw terminals	2	●	<b>1</b>		920 240 <sup>1)</sup>	146
			Screw terminals	4		<b>2</b>		926 340 <sup>1)</sup>	152
			Screw terminals	2		<b>2</b>		926 240 <sup>1)</sup>	153
			Screw terminals	4	●	<b>1</b>		920 345 <sup>1)</sup>	144
			Screw terminals	2	●	<b>1</b>		920 245 <sup>1)</sup>	146
			Screw terminals	4		<b>2</b>		926 345 <sup>1)</sup>	152
			Screw terminals	2		<b>2</b>		926 245 <sup>1)</sup>	153
			Spring terminals	2		<b>2</b>		917 942	164
			LSA	20		<b>1</b>		907 401 + 907 443 + 907 498	175 177
			Screw terminals	4	●	<b>1</b>		920 371 <sup>1)</sup>	146
			Screw terminals	2	●	<b>1</b>		920 271 <sup>1)</sup>	147
<b>LUXMATE bus</b> 			Screw terminals	4	●	<b>1</b>		920 344 <sup>1)</sup>	144
			Screw terminals	2	●	<b>1</b>		920 244 <sup>1)</sup>	146
			Screw terminals	4		<b>2</b>		926 344 <sup>1)</sup>	152
			Screw terminals	2		<b>2</b>		926 244 <sup>1)</sup>	153
<b>M bus</b> 			Screw terminals	4	●	<b>1</b>		920 345 <sup>1)</sup>	144
			Screw terminals	2	●	<b>1</b>		920 245 <sup>1)</sup>	146
			Screw terminals	4		<b>2</b>		926 345 <sup>1)</sup>	152
			Screw terminals	2		<b>2</b>		926 245 <sup>1)</sup>	153
			Spring terminals	2		<b>2</b>		917 942	164
			LSA	20		<b>1</b>		907 401 + 907 443 + 907 498	175 177
<b>Melsec Net 2</b>			BNC	1		<b>2</b>		929 010	202
			BNC	1		<b>2</b>		909 710 / 711	204

<sup>1)</sup> with universal base part BXT BAS (Part No. 920 300) or BSP BAS 4 (Part No. 926 304) please refer to page 142  
<sup>2)</sup> with universal base part BXT BAS EX (Part No. 920 301) please refer to page 156



























































































Bus systems and measuring and control equipment

Interface / Signal	For mounting on	Ex	Connection system	Protected lines	LifeCheck 	SPD class TYPE	SPD 	Part No.	Page	
<b>MODBUS</b>  			Screw terminals	4	●	<b>1</b>		920 371 <sup>1)</sup>	146	
			Screw terminals	2	●	<b>1</b>		920 271 <sup>1)</sup>	147	
			Screw terminals	4			<b>2</b>		926 371 <sup>1)</sup>	153
			Screw terminals	2			<b>2</b>		926 271 <sup>1)</sup>	154
			Spring terminals	2			<b>2</b>		917 970	164
			LSA	20			<b>1</b>	 + 907 465 + 907 498	907 401 175 177	
<b>MPI bus</b>  			Screw terminals	4	●	<b>1</b>		920 371 <sup>1)</sup>	146	
			Screw terminals	2	●	<b>1</b>		920 271 <sup>1)</sup>	147	
			Screw terminals	4			<b>2</b>		926 371 <sup>1)</sup>	153
			Screw terminals	2			<b>2</b>		926 271 <sup>1)</sup>	154
			Spring terminals	2			<b>2</b>		917 970	164
<b>N1 LAN</b>			Screw terminals	4	●	<b>1</b>		920 371 <sup>1)</sup>	146	
			Screw terminals	2	●	<b>1</b>		920 271 <sup>1)</sup>	147	
			Screw terminals	4	●	<b>1</b>		920 370 <sup>1)</sup>	145	
			Screw terminals	2	●	<b>1</b>		920 270 <sup>1)</sup>	147	
			Screw terminals	4			<b>2</b>		926 371 <sup>1)</sup>	153
			Screw terminals	2			<b>2</b>		926 271 <sup>1)</sup>	154
			Screw terminals	4			<b>2</b>		926 370 <sup>1)</sup>	152
			Screw terminals	2			<b>2</b>		926 270 <sup>1)</sup>	152
			Spring terminals	2			<b>2</b>		917 970	164
			BNC	1			<b>2</b>	 909 710 / 711	204	
<b>N2 bus</b> (Johnson Controls, LON, FTT 10)			Screw terminals	4	●	<b>1</b>		920 371 <sup>1)</sup>	146	
			Screw terminals	2	●	<b>1</b>		920 271 <sup>1)</sup>	147	
			Screw terminals	4			<b>2</b>		926 371 <sup>1)</sup>	153
			Screw terminals	2			<b>2</b>		926 271 <sup>1)</sup>	154
<b>Optocoupler interface</b>			Screw terminals	4	●	<b>1</b>		920 364 <sup>1)</sup>	145	
			Screw terminals	4			<b>2</b>		918 400	169
<b>Procontic CS31 (RS232)</b>			Screw terminals	4	●	<b>1</b>		920 322 <sup>1)</sup>	144	
			Screw terminals	4			<b>2</b>		926 322 <sup>1)</sup>	152
<b>Procontic T200 (RS422)</b>  			Screw terminals	4	●	<b>1</b>		920 371 <sup>1)</sup>	146	
			Screw terminals	4			<b>2</b>		926 371 <sup>1)</sup>	153
			Screw terminals	5			<b>2</b>		918 401	169

Easy Choice

<sup>1)</sup> with universal base part BXT BAS (Part No. 920 300) or BSP BAS 4 (Part No. 926 304) please refer to page 142  
<sup>2)</sup> with universal base part BXT BAS EX (Part No. 920 301) please refer to page 156

Bus systems and measuring and control equipment

Interface / Signal	For mounting on	Ex	Connection system	Protected lines	LifeCheck	SPD class TYPE	SPD	Part No.	Page
PROFIBUS-DP/FMS			Screw terminals	4	●	<b>1</b>		920 371 <sup>1)</sup>	146
			Screw terminals	2	●	<b>1</b>		920 271 <sup>1)</sup>	147
			Screw terminals	4	●	<b>2</b>		926 371 <sup>1)</sup>	153
			Screw terminals	2	●	<b>2</b>		926 271 <sup>1)</sup>	154
			9-pin SUB-D	4		<b>4</b>		924 017	207
			Spring terminals	2		<b>2</b>		917 970	164
			LSA	20		<b>1</b>		907 401 + 907 465 + 907 498	175 177
PROFIBUS-PA			Screw terminals	4	●	<b>1</b>		920 344 <sup>1)</sup>	144
			Screw terminals	2	●	<b>1</b>		920 244 <sup>1)</sup>	146
			Screw terminals	4		<b>2</b>		926 344 <sup>1)</sup>	152
			Screw terminals	2		<b>2</b>		926 244 <sup>1)</sup>	153
			Spring terminals	2		<b>2</b>		917 941	164
			Wires / terminals	2		<b>2</b>		929 941	184
			LSA	20		<b>1</b>		907 401 + 907 442 + 907 498	175 177
PROFIBUS-PA Ex (i)			Screw terminals	4	●	<b>2</b>		920 381 <sup>2)</sup>	156
			Screw terminals	2	●	<b>2</b>		920 538 <sup>2)</sup>	157
			Screw terminals	2	●	<b>2</b>		920 280 <sup>2)</sup>	156
			Screw terminals	2		<b>2</b>		920 383 <sup>2)</sup>	157
			Spring terminals	2		<b>2</b>		917 960	165
			Wires / terminals	2		<b>2</b>		929 960	185
			Wires	2		<b>2</b>		929 961 / 963	185
			Wires	4		<b>2</b>		929 950 / 951	186
			Screw terminals	4	●	<b>2</b>		989 408	158
PROFIBUS SIMATIC NET			Screw terminals	4	●	<b>1</b>		920 371 <sup>1)</sup>	146
			Screw terminals	2	●	<b>1</b>		920 271 <sup>1)</sup>	147
			Screw terminals	4		<b>2</b>		926 371 <sup>1)</sup>	153
			Screw terminals	2		<b>2</b>		926 271 <sup>1)</sup>	154
PSM-EG-RS422			Screw terminals	4	●	<b>1</b>		920 371 <sup>1)</sup>	146
			Screw terminals	4		<b>2</b>		926 371 <sup>1)</sup>	153
			Screw terminals	5		<b>2</b>		918 401	169
PSM-EG-RS485			Screw terminals	4	●	<b>1</b>		920 371 <sup>1)</sup>	146
			Screw terminals	2	●	<b>1</b>		920 271 <sup>1)</sup>	147
			Screw terminals	4		<b>2</b>		926 371 <sup>1)</sup>	153
			Screw terminals	2		<b>2</b>		926 271 <sup>1)</sup>	154
			Screw terminals	5		<b>2</b>		918 401	169
Rackbus (RS485)			Screw terminals	4	●	<b>1</b>		920 371 <sup>1)</sup>	146
			Screw terminals	2	●	<b>1</b>		920 271 <sup>1)</sup>	147
			Screw terminals	4		<b>2</b>		926 371 <sup>1)</sup>	153
			Screw terminals	2		<b>2</b>		926 271 <sup>1)</sup>	154
			Screw terminals	5		<b>2</b>		918 401	169

<sup>1)</sup> with universal base part BXT BAS (Part No. 920 300) or BSP BAS 4 (Part No. 926 304) please refer to page 142

<sup>2)</sup> with universal base part BXT BAS EX (Part No. 920 301) please refer to page 156

# Easy Choice according to Interface / Signal

## Bus systems and measuring and control equipment

Interface / Signal	For mounting on	Ex	Connection system	Protected lines	LifeCheck 	SPD class <b>TYPE</b>	SPD 	Part No.	Page
<b>R bus</b> 			Screw terminals	4		<b>1</b>		920 340 <sup>1)</sup>	144
			Screw terminals	2		<b>1</b>		920 240 <sup>1)</sup>	146
			Screw terminals	4		<b>2</b>		926 340 <sup>1)</sup>	152
			Screw terminals	2		<b>2</b>		926 240 <sup>1)</sup>	153
			Spring terminals	2		<b>2</b>		917 970	164
<b>RS 485</b> 			Screw terminals	4		<b>1</b>		920 371 <sup>1)</sup>	146
			Screw terminals	4		<b>2</b>		926 371 <sup>1)</sup>	153
			Screw terminals	4		<b>2</b>		920 538 <sup>2)</sup>	157
			Screw terminals	2		<b>1</b>		920 271 <sup>1)</sup>	147
			Screw terminals	2		<b>2</b>		926 271 <sup>1)</sup>	154
			Screw terminals	5		<b>2</b>		918 401	169
			Spring terminals	2		<b>2</b>		917 970	164
			Wires	2		<b>2</b>		929 971	186
			LSA	20		<b>1</b>		907 401 + 907 465 + 907 498	175 177
<b>RS422, V11</b> 			Screw terminals	4		<b>1</b>		920 371 <sup>1)</sup>	146
			Screw terminals	2		<b>1</b>		920 271 <sup>1)</sup>	147
			Screw terminals	4		<b>2</b>		926 371 <sup>1)</sup>	153
			Screw terminals	2		<b>2</b>		926 271 <sup>1)</sup>	154
			Screw terminals	5		<b>2</b>		918 401	169
			Spring terminals	2		<b>2</b>		917 970	164
			15-pin SUB-D	6		<b>2</b>		924 051	208
			LSA	20		<b>1</b>		907 401 + 907 465 + 907 498	175 177
<b>S bus</b>			Screw terminals	4		<b>1</b>		920 370 <sup>1)</sup>	145
			Screw terminals	2		<b>1</b>		920 270 <sup>1)</sup>	147
			Screw terminals	4		<b>2</b>		926 370 <sup>1)</sup>	152
			Screw terminals	2		<b>2</b>		926 270 <sup>1)</sup>	154
			Spring terminals	2		<b>2</b>		917 970	164
<b>SafetyBUS p</b> 			Screw terminals	4		<b>1</b>		920 371 <sup>1)</sup>	146
			Screw terminals	2		<b>1</b>		920 271 <sup>1)</sup>	147
			Screw terminals	4		<b>2</b>		926 371 <sup>1)</sup>	153
			Screw terminals	2		<b>2</b>		926 271 <sup>1)</sup>	154
			Spring terminals	2		<b>2</b>		917 970	164
<b>SDLC</b>			Screw terminals	4		<b>1</b>		920 370 <sup>1)</sup>	145
			Screw terminals	2		<b>1</b>		920 270 <sup>1)</sup>	147
			Screw terminals	4		<b>2</b>		926 370 <sup>1)</sup>	152
			Screw terminals	2		<b>2</b>		926 270 <sup>1)</sup>	154
			Spring terminals	2		<b>2</b>		917 970	164
<b>SDLS</b>			RJ45, screw terminals	4		<b>2</b>		918 410	170
			LSA	20		<b>1</b>		907 401 + 907 423 + 907 498	175 177

<sup>1)</sup> with universal base part BXT BAS (Part No. 920 300) or BSP BAS 4 (Part No. 926 304) please refer to page 142

<sup>2)</sup> with universal base part BXT BAS EX (Part No. 920 301) please refer to page 156







































Bus systems and measuring and control equipment

Interface / Signal	For mounting on	Ex	Connection system	Protected lines	LifeCheck	SPD class TYPE	SPD	Part No.	Page
<b>Securilan-LON-Bus</b> (LONWORKS technology Standard Bus based on Echelon)			Screw terminals	4		<b>1</b>		920 340 <sup>1)</sup>	144
			Screw terminals	2		<b>1</b>		920 240 <sup>1)</sup>	146
			Screw terminals	4		<b>2</b>		926 340 <sup>1)</sup>	152
			Screw terminals	2		<b>2</b>		926 240 <sup>1)</sup>	153
			Spring terminals	2		<b>2</b>		917 970	164
<b>SIGMASYS</b> (Siemens fire alarm system)			Screw terminals	4		<b>1</b>		920 345 <sup>1)</sup>	144
			Screw terminals	2		<b>1</b>		920 245 <sup>1)</sup>	146
			Screw terminals	4		<b>1</b>		920 325 <sup>1)</sup>	144
			Screw terminals	2		<b>1</b>		920 225 <sup>1)</sup>	147
			Screw terminals	4		<b>2</b>		926 345 <sup>1)</sup>	152
			Screw terminals	2		<b>2</b>		926 245 <sup>1)</sup>	153
			Screw terminals	4		<b>2</b>		926 325 <sup>1)</sup>	152
			Screw terminals	2		<b>2</b>		926 225 <sup>1)</sup>	153
			LSA	20		<b>1</b>		907 401 + 907 423 + 907 498	175 177
<b>SINEC L1</b>			Screw terminals	4		<b>1</b>		920 370 <sup>1)</sup>	145
			Screw terminals	2		<b>1</b>		920 270 <sup>1)</sup>	147
			Screw terminals	4		<b>2</b>		926 370 <sup>1)</sup>	152
			Screw terminals	2		<b>2</b>		926 270 <sup>1)</sup>	154
<b>SINEC L2</b>			Screw terminals	4		<b>1</b>		920 370 <sup>1)</sup>	145
			Screw terminals	2		<b>1</b>		920 270 <sup>1)</sup>	147
			Screw terminals	4		<b>2</b>		926 370 <sup>1)</sup>	152
			Screw terminals	2		<b>2</b>		926 270 <sup>1)</sup>	154
			Spring terminals	2		<b>2</b>		917 970	164
			9-pin SUB-D	4		<b>4</b>		924 017	207
<b>SS97 SIN/X (RS 232)</b>			Screw terminals	4		<b>1</b>		920 322 <sup>1)</sup>	144
			Screw terminals	2		<b>1</b>		920 222 <sup>1)</sup>	147
			Screw terminals	4		<b>2</b>		926 322 <sup>1)</sup>	152
			Screw terminals	2		<b>2</b>		926 222 <sup>1)</sup>	153
<b>SUCONET</b> 			Screw terminals	4		<b>1</b>		920 371 <sup>1)</sup>	146
			Screw terminals	2		<b>1</b>		920 271 <sup>1)</sup>	147
			Screw terminals	4		<b>2</b>		926 371 <sup>1)</sup>	153
			Screw terminals	2		<b>2</b>		926 271 <sup>1)</sup>	154
<b>Temperature measurement</b> PT 100, PT 1000, Ni 1000, NTC, PTC			Screw terminals	4		<b>1</b>		920 354 <sup>1)</sup>	145
			Screw terminals	4		<b>1</b>		920 322 <sup>1)</sup>	144
			Screw terminals	2		<b>1</b>		920 222 <sup>1)</sup>	147
			Screw terminals	4		<b>2</b>		926 322 <sup>1)</sup>	152
			Screw terminals	2		<b>2</b>		926 222 <sup>1)</sup>	153
			Spring terminals	2		<b>2</b>		917 920	164

<sup>1)</sup> with universal base part BXT BAS (Part No. 920 300) or BSP BAS 4 (Part No. 926 304) please refer to page 142

<sup>2)</sup> with universal base part BXT BAS EX (Part No. 920 301) please refer to page 156





































































## Bus systems and measuring and control equipment

Interface / Signal	For mounting on	Ex	Connection system	Protected lines	LifeCheck 	SPD class TYPE	SPD 	Part No.	Page
Temperature measurement Ex (i) PT 100, PT 1000 Ni 1000, NTC, PTC			Screw terminals	4	●	<b>2</b>		920 384 <sup>2)</sup>	157
TTL			Screw terminals	4	●	<b>1</b>		920 322 <sup>1)</sup>	144
			Screw terminals	2	●	<b>1</b>		920 222 <sup>1)</sup>	147
			Screw terminals	4		<b>2</b>		926 322 <sup>1)</sup>	152
			Screw terminals	2		<b>2</b>		926 222 <sup>1)</sup>	153
			Spring terminals	2		<b>2</b>		917 920	164
			15-pin SUB-D	4, 9		<b>2</b>		924 046	208
			9-pin SUB-D	9		<b>4</b>		924 019	208
TTY			Screw terminals	4	●	<b>1</b>		920 364 <sup>1)</sup>	145
			Screw terminals	4	●	<b>1</b>		926 362 <sup>1)</sup>	145
			Screw terminals	4		<b>2</b>		918 400	169
TTY 4 – 20 mA			Screw terminals	4	●	<b>1</b>		920 324 <sup>1)</sup>	144
			Screw terminals	2	●	<b>1</b>		920 224 <sup>1)</sup>	147
			Screw terminals	4		<b>2</b>		926 324 <sup>1)</sup>	152
			Screw terminals	2		<b>2</b>		926 224 <sup>1)</sup>	153
			Spring terminals	2		<b>2</b>		917 921	164
			Spring terminals	2		<b>3</b>		917 988	164
			Wires / terminals	2		<b>2</b>		929 921	185

<sup>1)</sup> with universal base part BXT BAS (Part No. 920 300) or BSP BAS 4 (Part No. 926 304) please refer to page 142

<sup>2)</sup> with universal base part BXT BAS EX (Part No. 920 301) please refer to page 156

Telecommunications, telephone systems

Interface / Signal	For mounting on	Connection system	Protected lines	LifeCheck 	SPD class TYPE	SPD 	Part No.	Page
a/b wires  		LSA	20		<b>1</b>		907 401 + 907 430 + 907 498	175 177
		RJ45, LSA / RJ45	8 x 2		<b>2</b>		929 071 / 072	192
		Screw terminals	4	●	<b>1</b>		920 347 <sup>1)</sup>	144
		Screw terminals	4		<b>2</b>		926 347 <sup>1)</sup>	152
		RJ45, screw terminals	2		<b>2</b>		918 411	170
		TAE, RJ12	2		<b>2</b>		909 310	195
		Spring terminals / RJ45	2		<b>2</b>		929 230	192
		Spring terminals	2		<b>1</b>		922 210	198
ADSL  		Screw terminals	4	●	<b>1</b>		920 347 <sup>1)</sup>	144
		Screw terminals	2	●	<b>1</b>		920 247 <sup>1)</sup>	146
		Screw terminals	4		<b>2</b>		926 347 <sup>1)</sup>	152
		Screw terminals	2		<b>2</b>		926 247 <sup>1)</sup>	153
		LSA	20		<b>1</b>		907 401 + 907 430 + 907 498	175 177
		TAE, RJ12	2		<b>2</b>		909 310	195
		RJ45, LSA / RJ45	8 x 2		<b>2</b>		929 071 / 072	192
		RJ45, screw terminals	2		<b>2</b>		918 411	170
		Spring terminals / RJ45	2		<b>2</b>		929 230	192
		Spring terminals	2		<b>1</b>		922 210	198
ADSL 2+  		LSA	20		<b>1</b>		907 401 + 907 430 + 907 498	175 177
		Screw terminals	4	●	<b>1</b>		920 347 <sup>1)</sup>	144
		Screw terminals	4		<b>2</b>		926 347 <sup>1)</sup>	152
		Spring terminals	2		<b>1</b>		922 210	198
Datex-P		Screw terminals	4	●	<b>1</b>		920 375 <sup>1)</sup>	146
		Screw terminals	4		<b>2</b>		926 375 <sup>1)</sup>	153
E1		RJ45	4 x 2		<b>2</b>		929 100	190
		RJ45	4 x 2		<b>2</b>		929 121	190
		RJ45	4 x 2		<b>2</b>		929 126	190
		LSA	20		<b>1</b>		907 401 + 907 470 + 907 498	175 177
		LSA / RJ45	8 x 4		<b>2</b>		929 075	192
		Screw terminals	4	●	<b>1</b>		920 375 <sup>1)</sup>	146
		Screw terminals	4		<b>2</b>		926 375 <sup>1)</sup>	153
G.703 coax		1.6/5.6 connector	1		<b>3</b>		929 040	204

<sup>1)</sup> with universal base part BXT BAS (Part No. 920 300) or BSP BAS 4 (Part No. 926 304) please refer to page 142  
<sup>2)</sup> with universal base part BXT BAS EX (Part No. 920 301) please refer to page 156

Telecommunications, telephone systems

Interface / Signal	For mounting on	Connection system	Protected lines	LifeCheck	SPD class TYPE	SPD	Part No.	Page
G.703 / G.704		Insulation displacement terminals	2		<b>2</b>		907 214	178
		LSA / RJ45	8 x 4		<b>2</b>		929 075	192
		RJ45	4 x 2		<b>2</b>		929 100	190
		RJ45	4 x 2		<b>2</b>		929 121	190
		RJ45	4 x 2		<b>2</b>		929 126	190
		LSA	20		<b>1</b>		907 401 + 907 470 + 907 498	175 177
		Screw terminals	4	●	<b>1</b>		920 375 <sup>1)</sup>	146
		Screw terminals	4		<b>2</b>		926 375 <sup>1)</sup>	153
HDSL		Screw terminals	4	●	<b>1</b>		920 375 <sup>1)</sup>	146
		Screw terminals	4		<b>2</b>		926 375 <sup>1)</sup>	153
		LSA	20		<b>1</b>		907 401 + 907 470 + 907 498	175 177
		RJ45	4 x 2		<b>2</b>		929 100	190
		RJ45	4 x 2		<b>2</b>		929 121	190
		RJ45	4 x 2		<b>2</b>		929 126	190
		LSA / RJ45	8 x 4		<b>2</b>		929 075	192
	IP telephone		RJ45	4 x 2		<b>2</b>		929 100
		RJ45	4 x 2		<b>2</b>		929 121	190
		RJ45	4 x 2		<b>2</b>		929 126	190
		RJ45	8 x 8		<b>4</b>		929 037	191
		RJ45	4		<b>2</b>		909 321	195
		Spring terminals	2		<b>1</b>		922 210	198
ISDN S <sub>0</sub>		Screw terminals	4	●	<b>1</b>		920 375 <sup>1)</sup>	146
		Screw terminals	4		<b>2</b>		926 375 <sup>1)</sup>	153
		RJ45	4		<b>2</b>		929 024	200
		LSA	20		<b>1</b>		907 401 + 907 470 + 907 498	175 177
		RJ45	4		<b>2</b>		909 320	195
		RJ45	4 x 2		<b>2</b>		929 100	190
		RJ45	4 x 2		<b>2</b>		929 121	190
		RJ45	4 x 2		<b>2</b>		929 126	190
		RJ45, screw terminals	4		<b>2</b>		918 410	170
	ISDN S <sub>2m</sub> / U <sub>2m</sub>		Screw terminals	4	●	<b>1</b>		920 375 <sup>1)</sup>
		Screw terminals	4		<b>2</b>		926 375 <sup>1)</sup>	153
		LSA	20		<b>1</b>		907 401 + 907 470 + 907 498	175 177
		RJ45	4 x 2		<b>2</b>		929 100	190
		RJ45	4 x 2		<b>2</b>		929 121	190
		RJ45	4 x 2		<b>2</b>		929 126	190
		LSA / RJ45	8 x 4		<b>2</b>		929 075	192

<sup>1)</sup> with universal base part BXT BAS (Part No. 920 300) or BSP BAS 4 (Part No. 926 304) please refer to page 142  
<sup>2)</sup> with universal base part BXT BAS EX (Part No. 920 301) please refer to page 156

## Telecommunications, telephone systems

Interface / Signal	For mounting on	Connection system	Protected lines	LifeCheck	SPD class TYPE	SPD	Part No.	Page
ISDN U <sub>K0</sub> / U <sub>P0</sub>		Screw terminals	4	●	<b>1</b>		920 347 <sup>1)</sup>	144
		Screw terminals	2	●	<b>1</b>		920 247 <sup>1)</sup>	146
		Screw terminals	4		<b>2</b>		926 347 <sup>1)</sup>	152
		Screw terminals	2		<b>2</b>		926 247 <sup>1)</sup>	153
		LSA	20		<b>1</b>		907 401 + 907 430 + 907 498	175 177
		RJ45, LSA / RJ45	8 x 2		<b>2</b>		929 071 / 072	192
		TAE, RJ12	2		<b>2</b>		909 310	195
		RJ45, screw terminals	2		<b>2</b>		918 411	170
		Spring terminals / RJ45	10 x 2		<b>2</b>		929 230	192
		Spring terminals	2		<b>1</b>		922 210	198
Modem M1		Screw terminals	4	●	<b>1</b>		920 322 <sup>1)</sup>	144
		Screw terminals	2	●	<b>1</b>		920 222 <sup>1)</sup>	147
		Screw terminals	4		<b>2</b>		926 322 <sup>1)</sup>	152
		Screw terminals	2		<b>2</b>		926 222 <sup>1)</sup>	153
SDSL		RJ45	4 x 2		<b>2</b>		929 100	190
		RJ45	4 x 2		<b>2</b>		929 121	190
		RJ45	4 x 2		<b>2</b>		929 126	190
		LSA	20		<b>1</b>		907 401 + 907 470 + 907 498	175 177
		Screw terminals	4	●	<b>1</b>		920 375 <sup>1)</sup>	146
		Screw terminals	4		<b>2</b>		926 375 <sup>1)</sup>	153
		LSA / RJ45	8 x 4		<b>2</b>		929 075	192
SHDSL		Screw terminals	4	●	<b>1</b>		920 375 <sup>1)</sup>	146
		Screw terminals	4		<b>2</b>		926 375 <sup>1)</sup>	153
		RJ45	4 x 2		<b>2</b>		929 100	190
		RJ45	4 x 2		<b>2</b>		929 121	190
		RJ45	4 x 2		<b>2</b>		929 126	190
		LSA	20		<b>1</b>		907 401 + 907 470 + 907 498	175 177
		Screw terminals	4	●	<b>1</b>		920 310 <sup>1)</sup>	144
		Screw terminals	2	●	<b>1</b>		920 211 <sup>1)</sup>	148
		LSA / RJ45	8 x 4		<b>2</b>		929 075	192
Telephones System telephones e.g. Siemens, HICOM, Alcatel		Screw terminals	2	●	<b>1</b>		920 247 <sup>1)</sup>	146
		Screw terminals	2		<b>2</b>		926 247 <sup>1)</sup>	153
		RJ45, RJ11	4		<b>2</b>		929 028	200
		RJ12	2		<b>2</b>		929 081	200
		LSA	20		<b>1</b>		907 401 + 907 422 + 907 498	175 177
		LSA	20		<b>1</b>		907 401 + 907 445 + 907 498	175 177

<sup>1)</sup> with universal base part BXT BAS (Part No. 920 300) or BSP BAS 4 (Part No. 926 304) please refer to page 142

<sup>2)</sup> with universal base part BXT BAS EX (Part No. 920 301) please refer to page 156







































































Telecommunications, telephone systems

Interface / Signal	For mounting on	Connection system	Protected lines	LifeCheck	SPD class TYPE	SPD	Part No.	Page
... Part 2/2 ...		RJ45, LSA / RJ45	8 x 2		<b>2</b>		929 071 / 072	192
Telephones System telephones e.g. Siemens, HICOM, Alcatel  		TAE, RJ12	2		<b>2</b>		909 310	195
		RJ45, screw terminals	2		<b>2</b>		918 411	170
		Spring terminals / RJ45	10 x 2		<b>2</b>		929 230	192
		Spring terminals	2		<b>1</b>		922 210	198
		Spring terminals	2		<b>1</b>		922 210	198
T-DSL  		Screw terminals	4	●	<b>1</b>		920 347 <sup>1)</sup>	144
		Screw terminals	2	●	<b>1</b>		920 247 <sup>1)</sup>	146
		Screw terminals	4		<b>2</b>		926 347 <sup>1)</sup>	152
		Screw terminals	2		<b>2</b>		926 247 <sup>1)</sup>	153
		LSA	20		<b>1</b>		907 401 + 907 430 + 907 498	175 177
		TAE, RJ12	2		<b>2</b>		909 310	195
		RJ45, LSA / RJ45	8 x 2		<b>2</b>		929 071 / 072	192
		RJ45, screw terminals	2		<b>2</b>		918 411	170
		Spring terminals / RJ45	10 x 2		<b>2</b>		929 230	192
		Spring terminals	2		<b>1</b>		922 210	198
Telecommunication systems  		LSA	20		<b>1</b>		907 401 + 907 430 + 907 498	175 177
		RJ45, LSA / RJ45	8 x 2		<b>2</b>		929 071 / 072	192
		Screw terminals	4	●	<b>1</b>		920 347 <sup>1)</sup>	144
		Screw terminals	4		<b>2</b>		926 347 <sup>1)</sup>	152
		RJ45, screw terminals	2		<b>2</b>		918 411	172
		TAE, RJ12	2		<b>2</b>		909 310	197
		Spring terminals / RJ45	10 x 2		<b>2</b>		929 230	192
Universal lightning equipotential bonding		Screw terminals	4	●	<b>1</b>		920 310 <sup>1)</sup>	146
		Screw terminals	2	●	<b>1</b>		920 211 <sup>1)</sup>	148
		LSA	20		<b>1</b>		907 400	175
		LSA	20		<b>1</b>		907 401	175
		Insulation displacement terminals	20		<b>2</b>		907 214	178
		Insulation displacement terminals	20		<b>2</b>		907 216	178
VDSL  		LSA	20		<b>1</b>		907 401	175
		Screw terminals	4	●	<b>1</b>		920 310 <sup>1)</sup>	144
		Screw terminals	2	●	<b>1</b>		920 211 <sup>1)</sup>	148
		Spring terminals	2		<b>1</b>		922 210	198
VDSL2		Spring terminals	2		<b>1</b>		922 210	198

<sup>1)</sup> with universal base part BXT BAS (Part No. 920 300) or BSP BAS 4 (Part No. 926 304) please refer to page 142





















































<sup>2)</sup> with universal base part BXT BAS EX (Part No. 920 301) please refer to page 156

Data networks

Interface / Signal	For mounting on	Connection system	Protected lines	LifeCheck 	SPD class TYPE	SPD 	Part No.	Page
Arcnet		BNC	1		<b>2</b>		929 010	202
		BNC	1		<b>2</b>		909 710 / 711	204
ATM		RJ45	4 x 2		<b>2</b>		929 100	190
		RJ45	4 x 2		<b>2</b>		929 121	190
		RJ45	4 x 2		<b>2</b>		929 126	190
		RJ45, LSA / RJ45	8 x 8		<b>3</b>		929 035 / 036	191
		RJ45	8 x 8		<b>4</b>		929 037	191
		RJ45	4		<b>2</b>		909 321	195
Ethernet 10/100/1000  10 Base T		RJ45	4 x 2		<b>2</b>		929 100	190
		RJ45	4 x 2		<b>2</b>		929 121	190
		RJ45	4 x 2		<b>2</b>		929 126	190
		RJ45, LSA / RJ45	8 x 8		<b>3</b>		929 035 / 036	191
		RJ45	8 x 8		<b>4</b>		929 037	191
		RJ45	4		<b>2</b>		909 321	195
		RJ45	4		<b>2</b>		909 320	195
		LSA	20		<b>1</b>		907 401 + 907 470 + 907 498	175 177
FDDI, CDDI		RJ45	4 x 2		<b>2</b>		929 100	190
		RJ45	4 x 2		<b>2</b>		929 121	190
		RJ45	4 x 2		<b>2</b>		929 126	190
		RJ45, LSA / RJ45	8 x 8		<b>3</b>		929 035 / 036	191
		RJ45	8 x 8		<b>4</b>		929 037	191
		RJ45	4		<b>2</b>		909 321	195
Industrial Ethernet		LSA	20		<b>1</b>		907 401 + 907 470 + 907 498	175 177
		RJ45	4 x 2		<b>2</b>		929 100	190
		RJ45	4 x 2		<b>2</b>		929 121	190
		RJ45	4 x 2		<b>2</b>		929 126	190
		RJ45, LSA / RJ45	8 x 8		<b>3</b>		929 035 / 036	191
		RJ45	8 x 8		<b>4</b>		929 037	191
		RJ45	4		<b>2</b>		909 321	195
Power over Ethernet PoE		RJ45	4 x 2		<b>2</b>		929 100	190
		RJ45	4 x 2		<b>2</b>		929 121	190
		RJ45	4 x 2		<b>2</b>		929 126	190
		RJ45	8 x 8		<b>4</b>		929 037	191











































































1) with universal base part BXT BAS (Part No. 920 300) or BSP BAS 4 (Part No. 926 304) please refer to page 142  
 2) with universal base part BXT BAS EX (Part No. 920 301) please refer to page 156

Data networks

Interface / Signal	For mounting on	Connection system	Protected lines	LifeCheck 	SPD class TYPE	SPD 	Part No.	Page
Token Ring		LSA	20		<b>1</b>		907 401 + 907 470 + 907 498	175 177
		RJ45	4 x 2		<b>2</b>		929 100	190
		RJ45	4 x 2		<b>2</b>		929 121	190
		RJ45	4 x 2		<b>2</b>		929 126	190
		RJ45, LSA / RJ45	8 x 8		<b>3</b>		929 035 / 036	191
		RJ45	8 x 8		<b>4</b>		929 037	191
		RJ45	4		<b>2</b>		909 321	195
V 24 (RS232 C)		Screw terminals	4		<b>1</b>		920 322 <sup>1)</sup>	144
		Screw terminals	4		<b>2</b>		926 322 <sup>1)</sup>	152
		Spring terminals	2		<b>2</b>		917 921	164
		LSA	20		<b>1</b>		907 401 + 907 421 + 907 498	175 177
		9-, 25-pin SUB-D	4, 9		<b>2</b>		924 046 / 061	208
		9-, 25-pin SUB-D	9		<b>4</b>		924 018 / 019	208
VG-AnyLAN		RJ45	4 x 2		<b>2</b>		929 100	190
		RJ45	4 x 2		<b>2</b>		929 121	190
		RJ45	4 x 2		<b>2</b>		929 126	190
		RJ45, LSA / RJ45	8 x 8		<b>3</b>		929 035 / 036	191
		RJ45	8 x 8		<b>4</b>		929 037	191
		RJ45	4		<b>2</b>		909 321	195
Voice over IP		RJ45	4 x 2		<b>2</b>		929 100	190
		RJ45	4 x 2		<b>2</b>		929 121	190
		RJ45	4 x 2		<b>2</b>		929 126	190
		RJ45	8 x 8		<b>4</b>		929 037	191
		RJ45	4		<b>2</b>		909 321	195
		Spring terminals	2		<b>1</b>		922 210	198









































































<sup>1)</sup> with universal base part BXT BAS (Part No. 920 300) or BSP BAS 4 (Part No. 926 304) please refer to page 142  
<sup>2)</sup> with universal base part BXT BAS EX (Part No. 920 301) please refer to page 156

## Antenna systems, broadband systems, transmitting and receiving systems, video systems

Interface / Signal	For mounting on	Connection system	Protected lines	Frequency range	SPD class <b>TYPE</b>	SPD	Part No.	Page
AMPS, NADAC (824 – 894 MHz)		SMA	1	d.c. – 5.8 GHz	<b>2</b>		929 039	204
		BNC	1	d.c. – 4 GHz	<b>2</b>		929 042	204
		BNC	1	d.c. – 1 GHz	<b>1</b>		929 043	205
		N connector	1	d.c. – 5.8 GHz	<b>2</b>		929 044	204
		N connector	1	d.c. – 2.5 GHz	<b>1</b>		929 045	205
		7/16 connector	1	d.c., 690 MHz – 2.7 GHz	<b>1</b>		929 146	205
		7/16 connector	1	690 MHz – 2.7 GHz	<b>1</b>		929 148	205
BWA (Broadband Wireless Access)		SMA	1	d.c. – 5.8 GHz	<b>2</b>		929 039	204
		BNC	1	d.c. – 4 GHz	<b>2</b>		929 042	204
		N connector	1	d.c. – 5.8 GHz	<b>2</b>		929 044	204
		N connector	1	2,0 – 6.0 GHz	<b>1</b>		929 059	205
CATV (cable TV)		F connector	1	d.c., 5 – 2400 MHz	<b>1</b>		909 705	204
		IEC/F connector	1	d.c. – 2400 MHz	<b>2</b>		909 300	194
DCF 77		SMA	1	d.c. – 5.8 GHz	<b>2</b>		929 039	204
		BNC	1	d.c. – 4 GHz	<b>2</b>		929 042	204
		BNC	1	d.c. – 1 GHz	<b>1</b>		929 043	205
		Screw terminals	2	d.c. – 2.8 MHz	<b>1</b>		920 242 <sup>1)</sup>	146
		Screw terminals	2	d.c. – 2.8 MHz	<b>2</b>		926 242 <sup>1)</sup>	153
DCS 1800 B162 (1710 – 1880 MHz)		SMA	1	d.c. – 5.8 GHz	<b>2</b>		929 039	204
		BNC	1	d.c. – 4 GHz	<b>2</b>		929 042	204
		N connector	1	d.c. – 5.8 GHz	<b>2</b>		929 044	204
		N connector	1	d.c. – 2.5 GHz	<b>1</b>		929 045	205
		7/16 connector	1	d.c., 690 MHz – 2.7 GHz	<b>1</b>		929 146	205
		7/16 connector	1	690 MHz – 2.7 GHz	<b>1</b>		929 148	205
GPS (1565 – 1585 MHz)		SMA	1	d.c. – 5.8 GHz	<b>2</b>		929 039	204
		BNC	1	d.c. – 4 GHz	<b>2</b>		929 042	204
		N connector	1	d.c. – 5.8 GHz	<b>2</b>		929 044	204
		N connector	1	d.c. – 2.5 GHz	<b>1</b>		929 045	205
		7/16 connector	1	d.c., 690 MHz – 2.7 GHz	<b>1</b>		929 146	205
		7/16 connector	1	690 MHz – 2.7 GHz	<b>1</b>		929 148	205
GSM 900, GSMR (876 – 960 MHz)		SMA	1	d.c. – 5.8 GHz	<b>2</b>		929 039	204
		BNC	1	d.c. – 4 GHz	<b>2</b>		929 042	204
		BNC	1	d.c. – 1 GHz	<b>1</b>		929 043	205
		N connector	1	d.c. – 5.8 GHz	<b>2</b>		929 044	204
		N connector	1	d.c. – 2.5 GHz	<b>1</b>		929 045	205
		7/16 connector	1	d.c., 690 MHz – 2.7 GHz	<b>1</b>		929 146	205
		7/16 connector	1	690 MHz – 2.7 GHz	<b>1</b>		929 148	205









































<sup>1)</sup> with universal base part BXT BAS (Part No. 920 300) or BSP BAS 4 (Part No. 926 304) please refer to page 142<sup>2)</sup> with universal base part BXT BAS EX (Part No. 920 301) please refer to page 156

Antenna systems, broadband systems, transmitting and receiving systems, video systems

Interface / Signal	For mounting on	Connection system	Protected lines	Frequency range	SPD class TYPE	SPD	Part No.	Page
LTE (698 – 2690 MHz)		7/16 connector	1	d.c., 690 MHz – 2.7 GHz	<b>1</b>		929 146	205
		7/16 connector	1	690 MHz – 2.7 GHz	<b>1</b>		929 148	205
PCS 1900 (1850 – 1990 MHz)		SMA	1	d.c. – 5.8 GHz	<b>2</b>		929 039	204
		BNC	1	d.c. – 4 GHz	<b>2</b>		929 042	204
		N connector	1	d.c. – 5.8 GHz	<b>2</b>		929 044	204
		N connector	1	d.c. – 2.5 GHz	<b>1</b>		929 045	205
		7/16 connector	1	d.c., 690 MHz – 2.7 GHz	<b>1</b>		929 146	205
		7/16 connector	1	690 MHz – 2.7 GHz	<b>1</b>		929 148	205
Radio systems		SMA	1	d.c. – 5.8 GHz	<b>2</b>		929 039	204
		BNC	1	d.c. – 4 GHz	<b>2</b>		929 042	204
		BNC	1	d.c. – 1 GHz	<b>1</b>		929 043	205
		N connector	1	d.c. – 5.8 GHz	<b>2</b>		929 044	204
		N connector	1	d.c. – 2.5 GHz	<b>1</b>		929 045	205
		7/16 connector	1	d.c., 690 MHz – 2.7 GHz	<b>1</b>		929 146	205
		7/16 connector	1	380 – 512 MHz	<b>1</b>		929 047	205
		7/16 connector	1	690 MHz – 2.7 GHz	<b>1</b>		929 148	205
SAT		F connector	1	d.c., 5 – 2400 MHz	<b>1</b>		909 705	204
		F connector	1	d.c., 5 – 3000 MHz	<b>3</b>		909 703	204
		F connector	1	d.c. – 2400 MHz	<b>1</b>		909 704	204
Sky DSL		F connector	1	d.c., 5 – 2400 MHz	<b>1</b>		909 705	204
TETRA, NMT 450 (380 – 512 MHz)		SMA	1	d.c. – 5.8 GHz	<b>2</b>		929 039	204
		BNC	1	d.c. – 4 GHz	<b>2</b>		929 042	204
		BNC	1	d.c. – 1 GHz	<b>1</b>		929 043	205
		N connector	1	d.c. – 5.8 GHz	<b>2</b>		929 044	206
		N connector	1	d.c. – 2.5 GHz	<b>1</b>		929 045	205
		7/16 connector	1	380 – 512 MHz	<b>1</b>		929 047	205
TV		F connector	1	d.c., 5 – 3000 MHz	<b>3</b>		909 703	204
		F connector	1	d.c. – 2400 MHz	<b>1</b>		909 704	204
		F connector	1	d.c., 5 – 2400 MHz	<b>1</b>		909 705	204
		IEC/F connector	1	d.c. – 2400 MHz	<b>2</b>		909 300	194
UMTS		SMA	1	d.c. – 5.8 GHz	<b>2</b>		929 039	204
		BNC	1	d.c. – 4 GHz	<b>2</b>		929 042	204
		N connector	1	d.c. – 5.8 GHz	<b>2</b>		929 044	204
		N connector	1	d.c. – 2.5 GHz	<b>1</b>		929 045	205
		7/16 connector	1	d.c., 690 MHz – 2.7 GHz	<b>1</b>		929 146	205
		7/16 connector	1	690 MHz – 2.7 GHz	<b>1</b>		929 148	205

1) with universal base part BXT BAS (Part No. 920 300) or BSP BAS 4 (Part No. 926 304) please refer to page 142  
 2) with universal base part BXT BAS EX (Part No. 920 301) please refer to page 156

Antenna systems, broadband systems, transmitting and receiving systems, video systems

Interface / Signal	For mounting on	Connection system	Protected lines	Frequency range	SPD class TYPE	SPD	Part No.	Page
Video (two-wire)		Screw terminals	4	d.c. – 100 MHz	<b>1</b>		920 371 <sup>1)</sup>	146
		Screw terminals	2	d.c. – 100 MHz	<b>1</b>		920 271 <sup>1)</sup>	147
		Screw terminals	4	d.c. – 100 MHz	<b>2</b>		926 371 <sup>1)</sup>	153
		Screw terminals	2	d.c. – 100 MHz	<b>2</b>		926 271 <sup>1)</sup>	154
		RJ45	4 x 2	d.c. – 250 MHz	<b>2</b>		929 100	190
		RJ45	4 x 2	d.c. – 250 MHz	<b>2</b>		929 121	190
		RJ45	4 x 2	d.c. – 250 MHz	<b>2</b>		929 126	190
		Screw terminals	2	d.c. – 100 MHz	<b>1</b>		920 270 <sup>1)</sup>	147
		Screw terminals	2	d.c. – 100 MHz	<b>2</b>		926 270 <sup>1)</sup>	154
		RJ45	4		<b>2</b>		909 321	195
		LSA	20	d.c. – 90 MHz	<b>1</b>		907 401 + 907 465 + 907 498	175 177
Video (coaxial)		BNC	1	d.c. – 300 MHz	<b>2</b>		929 010	202
		BNC	1	0 – 300 MHz	<b>2</b>		909 710 / 711	204
WiMax		N connector	1	2.0 – 6.0 GHz	<b>1</b>		929 059	205
WLAN (2.4 GHz band)		SMA	1	d.c. – 5.8 GHz	<b>2</b>		929 039	204
		BNC	1	d.c. – 4 GHz	<b>2</b>		929 042	204
		N connector	1	d.c. – 5.8 GHz	<b>2</b>		929 044	204
WLAN (5 GHz band)		SMA	1	d.c. – 5.8 GHz	<b>2</b>		929 039	204
		N connector	1	d.c. – 5.8 GHz	<b>2</b>		929 044	204
		N connector	1	2.0 – 6.0 GHz	<b>1</b>		929 059	205



**BLITZDUCTOR® XTU / DEHNbox actiVsense**

Universal lightning current / surge arrester with actiVsense® technology

- Automatically detects the operating voltage
- Optimally adapts the voltage protection level to the voltage currently applied











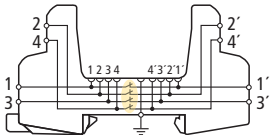

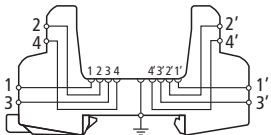



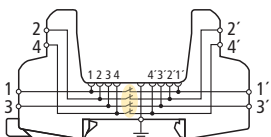

Application:

- Suitable for the vast majority of applications in information technology systems
  - Ideally suited for telecommunications systems, bus systems as well as measuring and control equipment
- ⇒ The nominal current of the SPD is limited to 100 mA, allowing the device to be used in the vast majority of information technology systems. In some applications where the signal line is also used for power supply the current may exceed 100 mA.
- ⇒ All signals are transmitted with signal frequencies up to 50 MHz.
- ⇒ In bus systems the SPD can be used for applications based on RS485 / RS422 interfaces (not RS232).

For more detailed information, please refer to page 149 (BXTU) and page 197 (DBX).

<sup>1)</sup> with universal base part BXT BAS (Part No. 920 300) or BSP BAS 4 (Part No. 926 304) please refer to page 142  
<sup>2)</sup> with universal base part BXT BAS EX (Part No. 920 301) please refer to page 156

## Pluggable SPDs – DIN Rail mounted

Product	Basic circuit diagram / Symbol	Type	Part No.	Page
<b>BXT BAS / BSP BAS 4 base parts</b>				
		<b>BXT BAS</b> <ul style="list-style-type: none"> <li>– Universal base part for protection modules of the BLITZDUCTOR XT/XTU and BLITZDUCTOR SP series</li> <li>– <b>No signal disconnection</b> if the protection module is removed</li> <li>– Connection of up to four lines</li> </ul>	920 300	142
		<b>BSP BAS 4</b> <ul style="list-style-type: none"> <li>– Universal base part for protection modules of the BLITZDUCTOR XT/XTU and BLITZDUCTOR SP</li> <li>– <b>Signal disconnection</b> if the protection module is removed</li> <li>– Connection of up to four lines</li> </ul>	926 304	142
<b>BLITZDUCTOR® XT</b>				
	<b>TYPE 1 P1</b> 	<b>BXT ML ...</b> <ul style="list-style-type: none"> <li>– Combined lightning current and surge arrester modules</li> <li>– With integrated LifeCheck</li> <li>– Two-pole and four-pole versions</li> </ul>	920 XXX	144
<b>BLITZDUCTOR® XTU</b>				
	<b>TYPE 1 P1</b>  	<b>BXTU ML ...</b> <ul style="list-style-type: none"> <li>– Universal lightning current and surge arrester modules</li> <li>– With integrated LifeCheck</li> <li>– With integrated actiVsense technology</li> <li>– Two-pole and four-pole versions</li> </ul>	920 349 920 249	150 150
<b>BLITZDUCTOR® SP</b>				
	<b>TYPE 2 P1</b> 	<b>BSP M ...</b> <ul style="list-style-type: none"> <li>– Surge arrester modules</li> <li>– Two-pole and four-pole versions</li> </ul>	926 XXX	152
<b>BLITZDUCTOR® XT Ex (i)</b>				
		<b>BXT BAS EX</b> <ul style="list-style-type: none"> <li>– Universal base part for protection modules of the BLITZDUCTOR XT Ex (i) series</li> <li>– <b>No signal disconnection</b> if the protection module is removed</li> <li>– Connection of up to four lines</li> </ul>	920 301	156
	<b>TYPE 2 P1</b>   	<b>BXT ML ...</b> <ul style="list-style-type: none"> <li>– Surge arrester modules for hazardous areas</li> <li>– <b>With</b> integrated LifeCheck</li> <li>– Two-pole and four-pole versions</li> </ul>	920 XXX	156
	<b>TYPE 2 P1</b>  	<b>BXT M2 BD EX 24</b> <ul style="list-style-type: none"> <li>– Surge arrester modules for hazardous areas</li> <li>– Protection of one pair</li> <li>– Direct or indirect shielding</li> </ul>	920 383	157



## BLITZDUCTOR – Base Parts

- BXT BAS – Without signal disconnection / BSP BAS 4 – With signal disconnection
- Universal base parts for protection modules of the BLITZDUCTOR XT/XTU/SP series
- Two base parts with or without signal disconnection if the protection module is removed
- Connection of up to four lines

### BXT BAS

The BLITZDUCTOR XT base part is an extremely space-saving and universal four-pole **feed-through terminal** for the insertion of a protection module **without** signal disconnection if the protection module is removed. The snap-in mechanism at the supporting foot of the base part allows the protection module to be safely earthed via the DIN rail. Since no components of the protective circuit are situated in the base part, maintenance operation is only required for the protection modules.



Type	BXT BAS
Part No.	920 300
For mounting on	35 mm DIN rails acc. to EN 60715
Cross-sectional area, solid	0.08-4 mm <sup>2</sup>
Cross-sectional area, flexible	0.08-2.5 mm <sup>2</sup>
Tightening torque (terminals)	0.4 Nm
Earthing via	35 mm DIN rails acc. to EN 60715
Approvals	CSA, UL, EAC, ATEX, IECEx *)

\*) only in connection with an approved protection module

### BSP BAS 4

The BLITZDUCTOR SP base part is an extremely space-saving and universal four-pole **terminal** for the insertion of a protection module **with** signal disconnection if the protection module is removed. The snap-in mechanism at the supporting foot of the base part allows the protection module to be safely earthed via the DIN rail. Since no components of the protective circuit are situated in the base part, maintenance operation is only required for the protection modules.



Type	BSP BAS 4
Part No.	926 304
For mounting on	35 mm DIN rails acc. to EN 60715
Cross-sectional area, solid	0.08-4 mm <sup>2</sup>
Cross-sectional area, flexible	0.08-2.5 mm <sup>2</sup>
Tightening torque (terminals)	0.4 Nm
Earthing via	35 mm DIN rails acc. to EN 60715
Approvals	UL, CSA, EAC *)

\*) only in connection with an approved protection module





**BLITZDUCTOR® XT**

- Combined lightning current and surge arrester
  - Maximum discharge capacity for two-pole, three-pole or four-pole interfaces
  - Capable of carrying lightning currents up to 10 kA (10/350 μs)
  - Low voltage protection level, capable of protecting terminal equipment
- With integrated LifeCheck monitoring
  - Arrester testing during operation
  - Detection of pre-damaged arresters
  - High signal availability thanks to preventive replacement of arresters
- SPD consists of a protection module and a base part
  - Vibration and shock-tested for safe operation
  - All protection components integrated in the protection module
  - Two universal base parts with / without signal disconnection
  - Minimum space requirements, 4 single lines or 2 pairs over a width of 12 mm

BLITZDUCTOR XT combined arresters are pluggable and universal multi-pole DIN rail mounted lightning current and surge arresters for protecting measuring and control circuits, bus systems and telecommunication systems. They are particularly useful in installations and systems with high requirement on the availability.

To ensure effective protection of terminal equipment under lightning and overvoltage conditions, BLITZDUCTOR XT arresters combine the permanently high impulse current discharge capacity of a lightning current arrester with the low voltage protection level of a surge arrester.

LifeCheck allows quick and easy testing of arresters without ever removing the module from the system. Integrated in the protection modules, LifeCheck permanently monitors the operating state of the arrester and acts like an early warning system, detecting imminent electrical or thermal overload of the protection components. The status of the arrester can be



BLITZDUCTOR XT with an earthing module (grey). The lines can be tested by means of the measuring module (grey with lines) without disconnecting the terminals.

read in a second by the portable DEHNrecord LC reader with non-contact RFID technology. LifeCheck also saves and indicates the date of the last test of the protection module. Stationary installed, a condition monitoring system permanently monitors the condition of up to 10 BXT arresters.

The module locking system ensures safe operation. Thus, the arrester provides protection against vibration effects and shock up to a 30-fold acceleration of gravity. The function-optimised design of the arrester ensures both fast and easy replacement of protection modules which house all relevant protection elements.

A wide range of accessories makes BLITZDUCTOR XT arresters particularly easy to use. Elements for earthing unused lines or easily testing signal circuits round off the product range.

The **protection module** and **base part** must be ordered separately!



Two-part design with universal base part and application-specific protection module.



The module locking mechanism ensures that the module is vibration-proof and protected against polarity reversal.



All protection elements are integrated in the plug-in module and are monitored by means of LifeCheck.



EMC spring terminal for permanent low-impedance shield contact.

Pluggable SPDs – DIN Rail mounted

**BLITZDUCTOR® XT – Protection Modules with LifeCheck®**



**BXT ML4 B 180**

Space-saving four-pole lightning current arrester module with LifeCheck feature for almost all applications. For use in connection with downstream **TYPE 2** surge arresters or combined lightning current and surge arresters with a lower or equal voltage level.

Type BXT ...	<b>ML4 B 180</b>
Part No.	<b>920 310</b>
SPD class	<b>TYPE 1</b>
Max. continuous operating voltage (d.c.) (U <sub>c</sub> )	180 V
Nominal current at 45 °C (I <sub>n</sub> )	1.2 A
D1 Total lightning impulse current (10/350 μs) (I <sub>imp</sub> )	10 kA
C2 Total nominal discharge current (8/20 μs) (I <sub>n</sub> )	20 kA
Series resistance per line	0.4 ohm(s)
Approvals	CSA, EAC, ATEX, IECEx, CSA & USA Hazloc, SIL

Pluggable SPDs –  
DIN Rail mounted

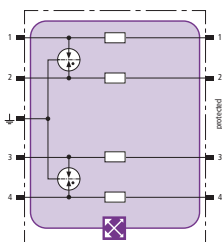

**BXT ML4 BE 5 – BE 180**

Space-saving combined lightning current and surge arrester module with LifeCheck feature for protecting four single lines sharing a common reference potential as well as unbalanced interfaces.

<b>General technical data:</b>	
D1 Total lightning impulse current (10/350 μs) (I <sub>imp</sub> )	10 kA
C2 Total nominal discharge current (8/20 μs) (I <sub>n</sub> )	20 kA

Type BXT ...	<b>ML4 BE 5</b>	<b>ML4 BE 12</b>	<b>ML4 BE 24</b>	<b>ML4 BE 36</b>
Part No.	<b>920 320</b>	<b>920 322</b>	<b>920 324</b>	<b>920 336</b>
SPD class	<b>TYPE 1 P1</b>	<b>TYPE 1 P1</b>	<b>TYPE 1 P1</b>	<b>TYPE 1 P1</b>
Max. continuous operating voltage (d.c.) (U <sub>c</sub> )	6 V	15 V	33 V	45 V
Nominal current at 45 °C (I <sub>n</sub> )	1.0 A	0.75 A	0.75 A	1.8 A
Series resistance per line	1.0 ohm(s)	1.8 ohm(s)	1.8 ohm(s)	0.43 ohm(s)
Cut-off frequency line-PG (f <sub>G</sub> )	1.0 MHz	2.7 MHz	6.8 MHz	3.8 MHz
Approvals	CSA, UL, EAC, ATEX, IECEx, CSA & USA Hazloc, SIL	CSA, UL, EAC, ATEX, IECEx, CSA & USA Hazloc, SIL	CSA, UL, EAC, ATEX, IECEx, CSA & USA Hazloc, SIL	UL, EAC, ATEX, IECEx, CSA & USA Hazloc, SIL

Type BXT ...	<b>ML4 BE 48</b>	<b>ML4 BE 60</b>	<b>ML4 BE 180</b>
Part No.	<b>920 325</b>	<b>920 326</b>	<b>920 327</b>
SPD class	<b>TYPE 1 P1</b>	<b>TYPE 1 P1</b>	<b>TYPE 1 P2</b>
Max. continuous operating voltage (d.c.) (U <sub>c</sub> )	54 V	70 V	180 V
Nominal current at 45 °C (I <sub>n</sub> )	0.75 A	1.0 A	1.0 A
Series resistance per line	1.8 ohm(s)	1.0 ohm(s)	1.0 ohm(s)
Cut-off frequency line-PG (f <sub>G</sub> )	8.7 MHz	9.0 MHz	25.0 MHz
Approvals	CSA, UL, EAC, ATEX, IECEx, CSA & USA Hazloc, SIL		



**BXT ML4 BD 5 – BD 180**

Space-saving combined lightning current and surge arrester module with LifeCheck feature for protecting two pairs of unearthed balanced interfaces.

<b>General technical data:</b>	
D1 Total lightning impulse current (10/350 μs) (I <sub>imp</sub> )	10 kA
C2 Total nominal discharge current (8/20 μs) (I <sub>n</sub> )	20 kA
Approvals	CSA, UL, EAC, ATEX, IECEx, CSA & USA Hazloc, SIL

Type BXT ...	<b>ML4 BD 5</b>	<b>ML4 BD 12</b>	<b>ML4 BD 24</b>
Part No.	<b>920 340</b>	<b>920 342</b>	<b>920 344</b>
SPD class	<b>TYPE 1 P1</b>	<b>TYPE 1 P1</b>	<b>TYPE 1 P1</b>
Max. continuous operating voltage (d.c.) (U <sub>c</sub> )	6.0 V	15 V	33 V
Nominal current at 45 °C (I <sub>n</sub> )	1.0 A	1.0 A	1.0 A
Series resistance per line	1.0 ohm(s)	1.0 ohm(s)	1.0 ohm(s)
Cut-off frequency line-line (f <sub>G</sub> )	1.0 MHz	2.8 MHz	7.8 MHz

Type BXT ...	<b>ML4 BD 48</b>	<b>ML4 BD 60</b>	<b>ML4 BD 180</b>
Part No.	<b>920 345</b>	<b>920 346</b>	<b>920 347</b>
SPD class	<b>TYPE 1 P1</b>	<b>TYPE 1 P1</b>	<b>TYPE 1 P2</b>
Max. continuous operating voltage (d.c.) (U <sub>c</sub> )	54 V	70 V	180 V
Nominal current at 45 °C (I <sub>n</sub> )	1.0 A	1.0 A	0.75 A
Series resistance per line	1.0 ohm(s)	1.0 ohm(s)	1.8 ohm(s)
Cut-off frequency line-line (f <sub>G</sub> )	8.7 MHz	11.0 MHz	25.0 MHz

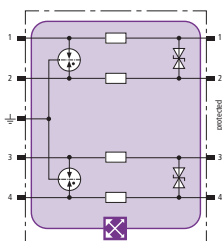

### BXT ML4 BPD 24

Space-saving combined arrester module with LifeCheck feature for protecting two pairs in 24 V d.c. systems. Can also be used for systems with earthed negative poles. Integrated PTC resistors allow to reliably reset the arrester after the system circuit has been affected by short-circuit currents up to 40 A.

Type BXT ...	ML4 BPD 24
Part No.	920 314 <sup>NEW</sup>
SPD class	TYPE 1 Pt
Max. continuous operating voltage (d.c.) ( $U_c$ )	33 V
Nominal current at 70 °C ( $I_n$ )	0.1 A
D1 Total lightning impulse current (10/350 $\mu$ s) ( $I_{imp}$ )	10 kA
C2 Total nominal discharge current (8/20 $\mu$ s) ( $I_n$ )	20 kA
Series resistance per line	typ. 10 ohm(s)
Cut-off frequency line-line ( $f_G$ )	4 MHz
Approvals	SIL

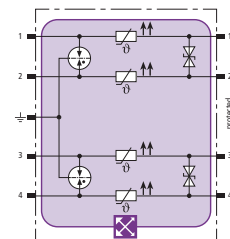

Pluggable SPDs –  
DIN Rail mounted

### BXT ML4 BC 5 / 24

Space-saving combined lightning current and surge arrester module with LifeCheck feature for protecting up to four unearthed single lines sharing a common reference potential.

Type BXT ...	ML4 BC 5	ML4 BC 24
Part No.	920 350	920 354
SPD class	TYPE 1 Pt	TYPE 1 Pt
Max. continuous operating voltage (d.c.) ( $U_c$ )	6.0 V	33 V
Nominal current at 45 °C ( $I_n$ )	1.0 A	0.75 A
D1 Total lightning impulse current (10/350 $\mu$ s) ( $I_{imp}$ )	10 kA	10 kA
C2 Total nominal discharge current (8/20 $\mu$ s) ( $I_n$ )	20 kA	20 kA
Series resistance per line	1.0 ohm(s)	1.8 ohm(s)
Cut-off frequency line-line ( $f_G$ )	1.0 MHz	5.7 MHz
Approvals	CSA, EAC, ATEX, IECEx, CSA & USA Hazloc, SIL	CSA, EAC, ATEX, IECEx, CSA & USA Hazloc, SIL

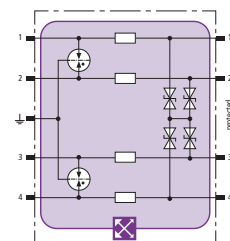

### BXT ML4 BE C 12 / 24

Space-saving combined lightning current and surge arrester module with LifeCheck feature for protecting two pairs of balanced interfaces with diode protective circuit at the input, current loops (TTY) and optocoupler inputs.

Type BXT ...	ML4 BE C 12	ML4 BE C 24
Part No.	920 362	920 364
SPD class	TYPE 1 Pt	TYPE 1 Pt
Max. continuous operating voltage (d.c.) ( $U_c$ )	15 V	33 V
Nominal current at 80 °C ( $I_n$ )	0.1 A	0.1 A
D1 Total lightning impulse current (10/350 $\mu$ s) ( $I_{imp}$ )	10 kA	10 kA
C2 Total nominal discharge current (8/20 $\mu$ s) ( $I_n$ )	20 kA	20 kA
Series resistance per line	13.8 ohm(s)	28.8 ohm(s)
Cut-off frequency line-PG ( $f_G$ )	0.85 MHz	1.7 MHz
Approvals	EAC, ATEX, IECEx, CSA & USA Hazloc, SIL	CSA, EAC, ATEX, IECEx, CSA & USA Hazloc, SIL

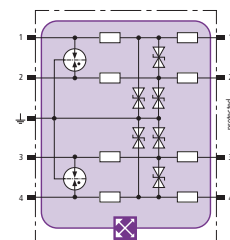

### BXT ML4 BE HF 5

Space-saving combined lightning current and surge arrester module with LifeCheck feature for protecting four single lines sharing a common reference potential as well as high-frequency transmissions which are not galvanically isolated.

Type BXT ...	ML4 BE HF 5
Part No.	920 370
SPD class	TYPE 1 Pt
Max. continuous operating voltage (d.c.) ( $U_c$ )	6.0 V
Nominal current at 45 °C ( $I_n$ )	1.0 A
D1 Total lightning impulse current (10/350 $\mu$ s) ( $I_{imp}$ )	10 kA
C2 Total nominal discharge current (8/20 $\mu$ s) ( $I_n$ )	20 kA
Series resistance per line	1.0 ohm(s)
Cut-off frequency line-PG ( $f_G$ )	100.0 MHz
Approvals	CSA, UL, EAC, ATEX, IECEx, CSA & USA Hazloc, SIL

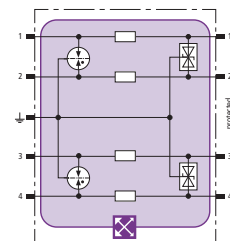



**BXT ML4 BD HF 5 / 24**

Space-saving combined lightning current and surge arrester module with LifeCheck feature for protecting two pairs in unearthed high-frequency bus systems or two-wire video transmission systems.

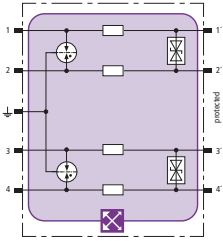

Type BXT ...	ML4 BD HF 5	ML4 BD HF 24
Part No.	920 371	920 375
SPD class	TYPE 1P1	TYPE 1P1
Max. continuous operating voltage (d.c.) (U <sub>c</sub> )	6.0 V	33 V
Nominal current at 45 °C (I <sub>n</sub> )	1.0 A	1.0 A
D1 Total lightning impulse current (10/350 μs) (I <sub>imp</sub> )	10 kA	10 kA
C2 Total nominal discharge current (8/20 μs) (I <sub>n</sub> )	20 kA	20 kA
Series resistance per line	1.0 ohm(s)	1.0 ohm(s)
Cut-off frequency line-line (f <sub>c</sub> )	100.0 MHz	100.0 MHz
Approvals	CSA, UL, EAC, ATEX, IECEx, CSA & USA Hazloc, SIL	CSA, UL, EAC, ATEX, IECEx, CSA & USA Hazloc, SIL



**BXT ML4 MY 110 / 250**

Space-saving surge arrester module with LifeCheck feature for protecting four lines of stranded signal interfaces.

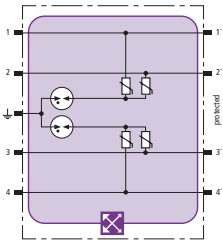

Type BXT ...	ML4 MY 110	ML4 MY 250
Part No.	920 388	920 389
SPD class	TYPE 2P2	TYPE 2P3
Max. continuous operating voltage (d.c.) line-line (U <sub>c</sub> )	170 V	620 V
Max. continuous operating voltage (d.c.) line-PG (U <sub>c</sub> )	85 V	320 V
Nominal current at 80 °C (I <sub>n</sub> )	3.0 A	3.0 A
C2 Total nominal discharge current (8/20 μs) (I <sub>n</sub> )	10 kA	10 kA
Cut-off frequency line-line (f <sub>c</sub> )	4.5 MHz	20.0 MHz
Approvals	EAC	EAC, SIL



**BXT ML2 BD 180**

Space-saving combined lightning current and surge arrester module with LifeCheck feature for protecting one pair of unearthed balanced interfaces.

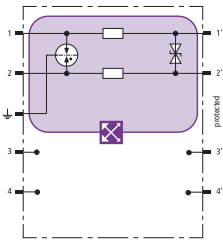

Type BXT ...	ML2 BD 180
Part No.	920 247
SPD class	TYPE 1P2
Max. continuous operating voltage (d.c.) (U <sub>c</sub> )	180 V
Nominal current at 45 °C (I <sub>n</sub> )	0.75 A
D1 Total lightning impulse current (10/350 μs) (I <sub>imp</sub> )	5 kA
C2 Total nominal discharge current (8/20 μs) (I <sub>n</sub> )	20 kA
Series resistance per line	1.8 ohm(s)
Cut-off frequency line-line (f <sub>c</sub> )	25.0 MHz
Approvals	CSA, EAC, ATEX, IECEx, CSA & USA Hazloc, SIL



**BXT ML2 BD S 5 – BD S 48**

Space-saving combined lightning current and surge arrester module with LifeCheck feature for protecting one pair of unearthed balanced interfaces, with direct or indirect shield earthing.

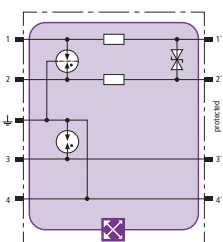

Type BXT ...	ML2 BD S 5	ML2 BD S 12	ML2 BD S 24	ML2 BD S 48
Part No.	920 240	920 242	920 244	920 245
SPD class	TYPE 1P1	TYPE 1P1	TYPE 1P1	TYPE 1P1
Max. continuous operating voltage (d.c.) (U <sub>c</sub> )	6.0 V	15 V	33 V	54 V
Nominal current at 45 °C (I <sub>n</sub> )	1.0 A	1.0 A	1.0 A	1.0 A
D1 Total lightning impulse current (10/350 μs) (I <sub>imp</sub> )	9 kA	9 kA	9 kA	9 kA
C2 Total nominal discharge current (8/20 μs) (I <sub>n</sub> )	20 kA	20 kA	20 kA	20 kA
Series resistance per line	1.0 ohm(s)	1.0 ohm(s)	1.0 ohm(s)	1.0 ohm(s)
Cut-off frequency line-line (f <sub>c</sub> )	1.0 MHz	2.8 MHz	7.8 MHz	8.7 MHz
Approvals	CSA, EAC, ATEX, IECEx, CSA & USA Hazloc, SIL	CSA, EAC, ATEX, IECEx, CSA & USA Hazloc, SIL	CSA, EAC, ATEX, IECEx, CSA & USA Hazloc, SIL	CSA, EAC, ATEX, IECEx, CSA & USA Hazloc, SIL

### BXT ML2 BE S 5 – BE S 48

Space-saving combined lightning current and surge arrester module with LifeCheck feature for protecting two single lines sharing a common reference potential as well as unbalanced interfaces, with direct or indirect shield earthing.

General technical data:	
SPD class	TYPE 1 P1
D1 Total lightning impulse current (10/350 $\mu$ s) ( $I_{imp}$ )	9 kA
C2 Total nominal discharge current (8/20 $\mu$ s) ( $I_n$ )	20 kA

Type BXT ...	ML2 BE S 5	ML2 BE S 12	ML2 BE S 24
Part No.	920 220	920 222	920 224
Max. continuous operating voltage (d.c.) ( $U_c$ )	6.0 V	15 V	33 V
Nominal current at 45 °C ( $I_n$ )	1.0 A	0.75 A	0.75 A
Series resistance per line	1.0 ohm(s)	1.8 ohm(s)	1.8 ohm(s)
Cut-off frequency line-PG ( $f_G$ )	1.0 MHz	2.7 MHz	6.8 MHz
Approvals	CSA, EAC, ATEX, IECEx, CSA & USA Hazloc, SIL	CSA, EAC, ATEX, IECEx, CSA & USA Hazloc, SIL	CSA, EAC, ATEX, IECEx, CSA & USA Hazloc, SIL

Type BXT ...	ML2 BE S 36	ML2 BE S 48
Part No.	920 226	920 225
Max. continuous operating voltage (d.c.) ( $U_c$ )	45 V	54 V
Nominal current at 45 °C ( $I_n$ )	1.8 A	0.75 A
Series resistance per line	0.43 ohm(s)	1.8 ohm(s)
Cut-off frequency line-PG ( $f_G$ )	3.8 MHz	8.7 MHz
Approvals	UL, EAC	CSA, UL, EAC, ATEX, IECEx, CSA & USA Hazloc, SIL

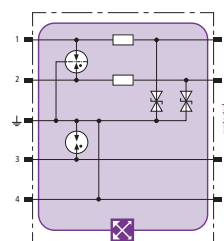

Pluggable SPDs –  
DIN Rail mounted

### BXT ML2 BE HFS 5

Space-saving combined lightning current and surge arrester module with LifeCheck feature for protecting one pair in high-frequency transmissions which are not galvanically isolated, with direct or indirect shield earthing.

Type BXT ...	ML2 BE HFS 5
Part No.	920 270
SPD class	TYPE 1 P1
Max. continuous operating voltage (d.c.) ( $U_c$ )	6.0 V
Nominal current at 45 °C ( $I_n$ )	1.0 A
D1 Total lightning impulse current (10/350 $\mu$ s) ( $I_{imp}$ )	9 kA
C2 Total nominal discharge current (8/20 $\mu$ s) ( $I_n$ )	20 kA
Series resistance per line	1.0 ohm(s)
Cut-off frequency line-PG ( $f_G$ )	100.0 MHz
Approvals	CSA, UL, EAC, ATEX, IECEx, CSA & USA Hazloc, SIL

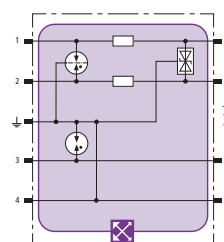

### BXT ML2 BD HFS 5

Space-saving combined lightning current and surge arrester module with LifeCheck feature for protecting one pair in unearthed high-frequency bus systems or video transmission systems, with direct or indirect shield earthing.

Type BXT ...	ML2 BD HFS 5
Part No.	920 271
SPD class	TYPE 1 P1
Max. continuous operating voltage (d.c.) ( $U_c$ )	6.0 V
Nominal current at 45 °C ( $I_n$ )	1.0 A
D1 Total lightning impulse current (10/350 $\mu$ s) ( $I_{imp}$ )	9 kA
C2 Total nominal discharge current (8/20 $\mu$ s) ( $I_n$ )	20 kA
Series resistance per line	1.0 ohm(s)
Cut-off frequency line-line ( $f_G$ )	100.0 MHz
Approvals	CSA, UL, EAC, ATEX, IECEx, CSA & USA Hazloc, SIL

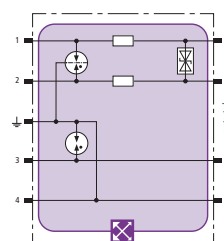

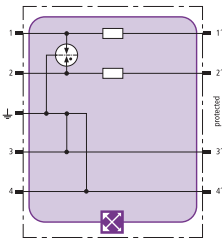

### BXT ML2 B 180

Space-saving two-pole lightning current arrester module with LifeCheck feature and shield earthing for almost all applications. For use in conjunction with downstream **TYPE 2 P1** surge arresters or combined lightning current and surge arresters with a lower or equal voltage level.

Type BXT ...	ML2 B 180
Part No.	920 211
SPD class	<b>TYPE 1 P1</b>
Max. continuous operating voltage (d.c.) ( $U_C$ )	180 V
Nominal current at 45 °C ( $I_L$ )	1.2 A
D1 Total lightning impulse current (10/350 $\mu$ s) ( $I_{imp}$ )	10 kA
C2 Total nominal discharge current (8/20 $\mu$ s) ( $I_n$ )	20 kA
Series resistance per line	0.4 ohm(s)
Approvals	CSA, EAC, ATEX, IECEx, CSA & USA Hazloc, SIL

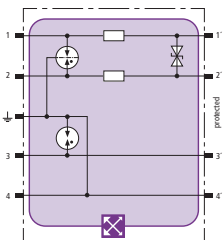

### BXT ML2 BD DL S 15

Space-saving combined lightning current and surge arrester module with LifeCheck feature for protecting one pair of unearthing balanced interfaces, which specifically fulfils the requirements of Dupline buses, direct or indirect shield earthing.

Type BXT ...	ML2 BD DL S 15
Part No.	920 243
SPD class	<b>TYPE 1 P1</b>
Max. continuous operating voltage (d.c.) ( $U_C$ )	17 V
Nominal current at 70 °C ( $I_L$ )	0.4 A
D1 Total lightning impulse current (10/350 $\mu$ s) ( $I_{imp}$ )	9 kA
C2 Total nominal discharge current (8/20 $\mu$ s) ( $I_n$ )	20 kA
Series resistance per line	2.2 ohm(s)
Cut-off frequency line-line ( $f_G$ )	2.7 MHz
Approvals	EAC, ATEX, IECEx, CSA & USA Hazloc, SIL

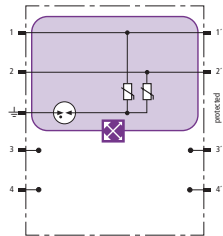

### BXT ML2 MY 250

Space-saving surge arrester module with LifeCheck feature for protecting two lines of stranded signal interfaces up to 250 V a.c.

Type BXT ...	ML2 MY 250
Part No.	920 289
SPD class	<b>TYPE 2 P3</b>
Max. continuous operating voltage (d.c.) line-line ( $U_C$ )	620 V
Max. continuous operating voltage (d.c.) line-PG ( $U_C$ )	320 V
Nominal current at 80 °C ( $I_L$ )	3.0 A
C2 Total nominal discharge current (8/20 $\mu$ s) ( $I_n$ )	5 kA
Cut-off frequency line-line ( $f_G$ )	20.0 MHz
Approvals	EAC

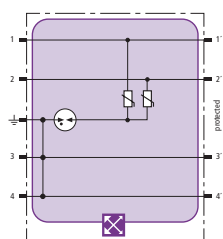

### BXT ML2 MY E 110

Space-saving surge arrester module with LifeCheck feature for protecting two pairs of stranded signal interfaces.

Type BXT ...	ML2 MY E 110
Part No.	920 288
SPD class	<b>TYPE 2 P2</b>
Max. continuous operating voltage (d.c.) line-line ( $U_C$ )	170 V
Max. continuous operating voltage (d.c.) line-PG ( $U_C$ )	85 V
Nominal current at 80 °C ( $I_L$ )	3.0 A
C2 Total nominal discharge current (8/20 $\mu$ s) ( $I_n$ )	5 kA
Series resistance per line	0 ohm(s)
Cut-off frequency line-line ( $f_G$ )	4.5 MHz
Approvals	EAC



**BLITZDUCTOR® XTU**

- Combined lightning current and surge arrester
  - Max. discharge capacity for balanced data interfaces
  - Capable of carrying lightning currents up to 10 kA (10/350 μs)
  - For installation in conformity with the lightning protection zone concept at the boundaries from 0<sub>A</sub> – 2 and higher
- With actiVsense technology
  - Automatically detects the signal voltage ranging from 0 to 180 V
  - Optimally adapts the voltage protection level to the currently applied signal
  - Capable of protecting terminal equipment due to adapted voltage protection level
  - One arrester type for two different data interfaces
- Integrated LifeCheck monitoring function
  - Arresters can be tested without downtime
  - Detection of pre-damaged arresters
  - High signal availability due to preventive replacement of arresters
- Arrester consists of a protection module and a base part
  - For DIN rail mounting with a standard base part
  - Easy replacement of protection modules
  - Vibration and shock-tested for safe operation
  - Two universal base parts with / without signal disconnection



BLITZDUCTOR XTU for protecting different balanced signal and data interfaces. Space-saving two-part design comprising a base part and a protection module for DIN rail mounting.

The compact BLITZDUCTOR XTU combined lightning current and surge arrester is designed for protecting information and automation equipment and systems and distinguishes itself through its unique actiVsense technology. The arrester does not have a specific nominal voltage and can thus be used for all voltages from 0 to 180 V with a superimposed signal voltage (± 5 V/50 MHz). The nominal current is limited to 100 mA which is completely sufficient for information technology systems.

Its innovative actiVsense technology allows the arrester to detect the signal voltage and to automatically adapt the voltage protection level to this voltage. This makes the arrester ideal for applications where changing or slowly fluctuating signal levels (≤ 400 Hz) are to be expected. In case of interference, BLITZDUCTOR XTU arresters always provide a minimal residual voltage for every signal voltage and therefore afford maximum protection for the devices and system circuits connected to them.

BLITZDUCTOR XTU is available in two versions. The four-pole version provides protection for two separate balanced interfaces, that is the arrester automatically detects the operating / signal voltage for every pair and optimally adapts the voltage protection level for every signal circuit. This allows to protect two different balanced interfaces by means of a single arrester, thus reducing installation time, saving costs and reducing the number of arresters to be used. If only one signal interface is to be protected, a two-pole version can be used for a balanced data interface (one pair). This version also allows to directly or indirectly connect cable shields to the equipotential bonding.

This DIN rail mounted arrester is ideally suited for use in information technology transmission systems such as telecommunication, bus or measuring and control systems.

The **protection module** and **base part** must be ordered separately!



Optimally adapted voltage protection level with integrated actiVsense technology ensures protection of terminal equipment.



The protection module of the pluggable arrester safely snaps into the base part, thus ensuring vibration and shock resistance.



To ensure high availability of the signal circuits, the integrated LifeCheck feature allows to quickly check whether arresters are pre-damaged.



DIN rail mounting by means of integrated earthing contact.

Pluggable SPDs – DIN Rail mounted

**BLITZDUCTOR® XTU – Protection Modules with LifeCheck®**

**BXTU ML4 BD 0-180**

Space-saving combined lightning current and surge arrester module with actiVsense and LifeCheck technology for protecting two pairs (same or different operating voltage) of balanced interfaces with galvanic isolation.

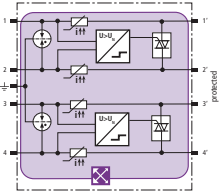

Type BXTU ...	ML4 BD 0-180
Part No.	920 349
SPD class	TYPE 1 P1
Max. continuous operating voltage (d.c.) ( $U_c$ )	180 V
Permissible superimposed signal voltage ( $U_{signal}$ )	$\leq \pm 5$ V
Cut-off frequency line-line ( $U_{signal}$ , balanced 100 ohms) ( $f_c$ )	50 MHz
Nominal current at 80 °C (equal to max. short-circuit current) ( $I_l$ )	100 mA
D1 Total lightning impulse current (10/350 $\mu$ s) ( $I_{imp}$ )	10 kA
C2 Total nominal discharge current (8/20 $\mu$ s) ( $I_n$ )	20 kA
Series resistance per line	$\leq 10$ ohms; typically 7.5 ohms
Approvals	CSA, UL, EAC, SIL

**BXTU ML2 BD S 0-180**

Space-saving combined lightning current and surge arrester module with actiVsense and LifeCheck technology for protecting one pair of balanced interfaces which are galvanically isolated. Direct or indirect shield earthing.

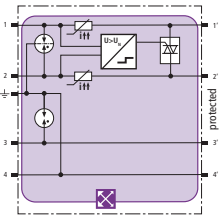

Type BXTU ...	ML2 BD S 0-180
Part No.	920 249
SPD class	TYPE 1 P1
Max. continuous operating voltage (d.c.) ( $U_c$ )	180 V
Permissible superimposed signal voltage ( $U_{signal}$ )	$\leq \pm 5$ V
Cut-off frequency line-line ( $U_{signal}$ , balanced 100 ohms) ( $f_c$ )	50 MHz
Nominal current at 80 °C (equal to max. short-circuit current) ( $I_l$ )	100 mA
D1 Total lightning impulse current (10/350 $\mu$ s) ( $I_{imp}$ )	9 kA
C2 Total nominal discharge current (8/20 $\mu$ s) ( $I_n$ )	20 kA
Series resistance per line	$\leq 10$ ohms; typically 7.5 ohms
Approvals	CSA, UL, EAC, SIL

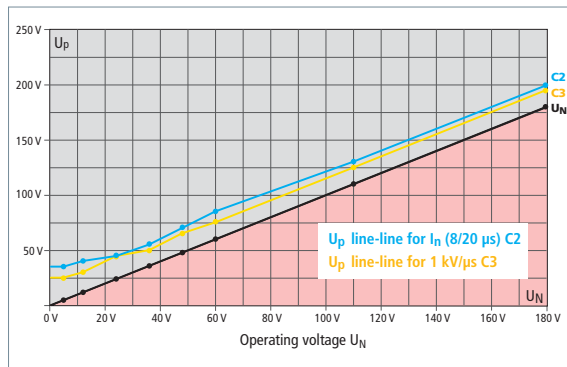

Voltage protection level diagram BXTU





**BLITZDUCTOR® SP**

- **Universal surge arrester**
  - Universal surge arrester for two-pole, three-pole or four-pole interfaces
  - High discharge capacity up to 20 kA (8/20 μs)
  - Low voltage protection level, capable of protecting terminal equipment
- **Arrester consists of a protection module and a base part**
  - Easy replacement of protection modules
  - All protection components integrated in the protection module
  - Two universal base parts with or without signal disconnection
- **Functional and appealing design**
  - DIN rail mounted device with integrated earthing
  - Minimum space requirements, four single lines or two pairs over a width 12 mm
  - Vibration and shock-tested for safe operation



Pluggable and universal multipole surge arrester for use in information technology systems.

Pluggable SPDs –  
DIN Rail mounted

BLITZDUCTOR SP arresters are pluggable and universal multipole DIN rail mounted surge arresters for protecting measuring and control circuits, bus systems, emergency alarm systems or telecommunication systems.

BLITZDUCTOR SP arresters combine a permanently high impulse current discharge capacity with an extremely low voltage protection level, thus ensuring effective protection of terminal equipment even in case of interference caused by impulse currents and surges resulting from switching operations.

The arresters provide protection against vibration effects and shock up to a 30-fold acceleration of gravity. The function-optimised arrester design ensures both fast and easy replacement of protection modules which house all relevant protection elements.

A wide range of accessories e.g. for earthing unused lines or easily testing lines complete the product range.

The **protection module** and **base part** have to be ordered separately!



Two-part design comprising a base part and a protection module.



The module locking mechanism ensures that the module is vibration-proof and protected against polarity reversal.



All protection elements are integrated in the plug-in module.



Two universal base parts with or without signal disconnection if the protection module is removed.

**BLITZDUCTOR® SP – Protection Modules**



**BSP M4 BE 5 – BE 180**

Space-saving surge arrester module for protecting four single lines sharing a common reference potential and unbalanced interfaces.

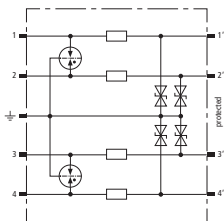

General technical data:	
D1 Lightning impulse current (10/350 $\mu$ s) per line ( $I_{imp}$ )	1 kA
C2 Total nominal discharge current (8/20 $\mu$ s) ( $I_n$ )	20 kA

Type BSP ...	M4 BE 5	M4 BE 12	M4 BE 24
Part No.	926 320	926 322	926 324
SPD class	TYPE 2 P1	TYPE 2 P1	TYPE 2 P1
Max. continuous operating voltage (d.c.) ( $U_c$ )	6.0 V	15 V	33 V
Nominal current at 45 °C ( $I_n$ )	1.0 A	0.75 A	0.75 A
Cut-off frequency line-PG ( $f_c$ )	1.0 MHz	2.7 MHz	6.8 MHz
Approvals	UL, CSA, SIL, EAC	UL, CSA, SIL, EAC	UL, CSA, SIL, EAC

Type BSP ...	M4 BE 48	M4 BE 60	M4 BE 180
Part No.	926 325	926 326	926 327
SPD class	TYPE 2 P1	TYPE 2 P1	TYPE 2 P2
Max. continuous operating voltage (d.c.) ( $U_c$ )	54 V	70 V	180 V
Nominal current at 45 °C ( $I_n$ )	0.75 A	1.0 A	1.0 A
Cut-off frequency line-PG ( $f_c$ )	8.7 MHz	9.0 MHz	25.0 MHz
Approvals	UL, CSA, SIL, EAC	UL, CSA, SIL, EAC	UL, CSA, SIL, EAC



**BSP M4 BD 5 – BD 180**

Space-saving surge arrester module for protecting two pairs of balanced interfaces with galvanic isolation.

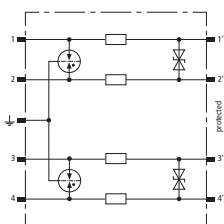

General technical data:	
D1 Lightning impulse current (10/350 $\mu$ s) per line ( $I_{imp}$ )	1 kA
C2 Total nominal discharge current (8/20 $\mu$ s) ( $I_n$ )	20 kA
Approvals	UL, CSA, SIL, EAC

Type BSP ...	M4 BD 5	M4 BD 12	M4 BD 24
Part No.	926 340	926 342	926 344
SPD class	TYPE 2 P1	TYPE 2 P1	TYPE 2 P1
Max. continuous operating voltage (d.c.) ( $U_c$ )	6.0 V	15 V	33 V
Nominal current at 45 °C ( $I_n$ )	1.0 A	1.0 A	1.0 A
Cut-off frequency line-line ( $f_c$ )	1.0 MHz	2.8 MHz	7.8 MHz

Type BSP ...	M4 BD 48	M4 BD 60	M4 BD 180
Part No.	926 345	926 346	926 347
SPD class	TYPE 2 P1	TYPE 2 P1	TYPE 2 P2
Max. continuous operating voltage (d.c.) ( $U_c$ )	54 V	70 V	180 V
Nominal current at 45 °C ( $I_n$ )	1.0 A	1.0 A	0.75 A
Cut-off frequency line-line ( $f_c$ )	8.7 MHz	11.0 MHz	25.0 MHz



**BSP M4 BE HF 5**

Space-saving surge arrester module for protecting four single lines sharing a common reference potential and high-frequency transmissions without galvanic isolation.

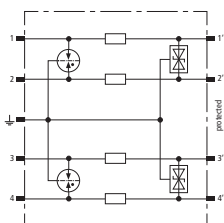

Type BSP ...	M4 BE HF 5
Part No.	926 370
SPD class	TYPE 2 P1
Max. continuous operating voltage (d.c.) ( $U_c$ )	6.0 V
Nominal current at 45 °C ( $I_n$ )	1.0 A
D1 Lightning impulse current (10/350 $\mu$ s) per line ( $I_{imp}$ )	1 kA
C2 Total nominal discharge current (8/20 $\mu$ s) ( $I_n$ )	20 kA
Cut-off frequency line-PG ( $f_c$ )	100.0 MHz
Approvals	UL, CSA, SIL, EAC

### BSP M4 BD HF 5 / 24

Space-saving surge arrester module for protecting two pairs of high-frequency bus systems or video transmission systems with galvanic isolation.

Type BSP ...	M4 BD HF 5	M4 BD HF 24
Part No.	926 371	926 375
SPD class	TYPE 2P1	TYPE 2P1
Max. continuous operating voltage (d.c.) ( $U_c$ )	6.0 V	33 V
Nominal current at 45 °C ( $I_n$ )	1.0 A	1.0 A
D1 Lightning impulse current (10/350 $\mu$ s) per line ( $I_{imp}$ )	1 kA	1 kA
C2 Total nominal discharge current (8/20 $\mu$ s) ( $I_n$ )	20 kA	20 kA
Cut-off frequency line-line ( $f_G$ )	100.0 MHz	100.0 MHz
Approvals	UL, CSA, SIL, EAC	UL, CSA, SIL, EAC

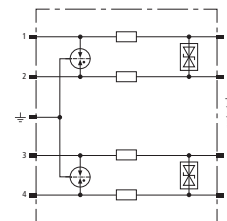

Pluggable SPDs –  
DIN Rail mounted

### BSP M2 BE 5 – BE 180

Space-saving surge arrester module for protecting two single lines sharing a common reference potential and unbalanced interfaces.

General technical data:	
D1 Lightning impulse current (10/350 $\mu$ s) per line ( $I_{imp}$ )	1 kA
C2 Total nominal discharge current (8/20 $\mu$ s) ( $I_n$ )	20 kA
Approvals	UL, CSA, SIL, EAC

Type BSP ...	M2 BE 5	M2 BE 12	M2 BE 24
Part No.	926 220	926 222	926 224
SPD class	TYPE 2P1	TYPE 2P1	TYPE 2P1
Max. continuous operating voltage (d.c.) ( $U_c$ )	6.0 V	15 V	33 V
Nominal current at 45 °C ( $I_n$ )	1.0 A	0.75 A	0.75 A
Cut-off frequency line-PG ( $f_G$ )	1.0 MHz	2.7 MHz	6.8 MHz

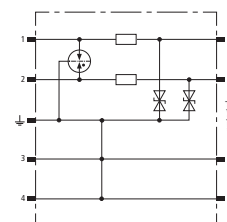

Type BSP ...	M2 BE 48	M2 BE 60	M2 BE 180
Part No.	926 225	926 226	926 227
SPD class	TYPE 2P1	TYPE 2P1	TYPE 2P2
Max. continuous operating voltage (d.c.) ( $U_c$ )	54 V	70 V	180 V
Nominal current at 45 °C ( $I_n$ )	0.75 A	1.0 A	1.0 A
Cut-off frequency line-PG ( $f_G$ )	8.7 MHz	9.0 MHz	25 MHz

### BSP M2 BD 5 – BD 180

Space-saving surge arrester module for protecting one pair of balanced interfaces with galvanic isolation.

General technical data:	
D1 Lightning impulse current (10/350 $\mu$ s) per line ( $I_{imp}$ )	1 kA
C2 Total nominal discharge current (8/20 $\mu$ s) ( $I_n$ )	20 kA
Approvals	UL, CSA, SIL, EAC

Type BSP ...	M2 BD 5	M2 BD 12	M2 BD 24
Part No.	926 240	926 242	926 244
SPD class	TYPE 2P1	TYPE 2P1	TYPE 2P1
Max. continuous operating voltage (d.c.) ( $U_c$ )	6.0 V	15 V	33 V
Nominal current at 45 °C ( $I_n$ )	1.0 A	1.0 A	1.0 A
Cut-off frequency line-line ( $f_G$ )	1.0 MHz	2.8 MHz	7.8 MHz

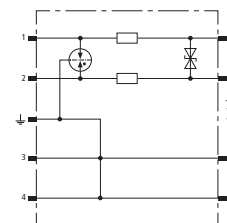

Type BSP ...	M2 BD 48	M2 BD 60	M2 BD 180
Part No.	926 245	926 246	926 247
SPD class	TYPE 2P1	TYPE 2P1	TYPE 2P2
Max. continuous operating voltage (d.c.) ( $U_c$ )	54 V	70 V	180 V
Nominal current at 45 °C ( $I_n$ )	1.0 A	1.0 A	0.75 A
Cut-off frequency line-line ( $f_G$ )	8.7 MHz	11 MHz	25.0 MHz



## BSP M2 BE HF 5

Space-saving surge arrester module for protecting two single lines sharing a common reference potential and high-frequency transmissions without galvanic isolation.

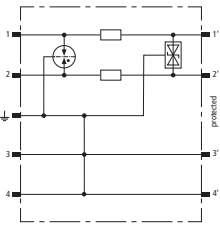

Type BSP ...	M2 BE HF 5
Part No.	926 270
SPD class	TYPE 2 P1
Max. continuous operating voltage (d.c.) ( $U_c$ )	6.0 V
Nominal current at 45 °C ( $I_n$ )	1.0 A
D1 Lightning impulse current (10/350 $\mu$ s) per line ( $I_{imp}$ )	1 kA
C2 Total nominal discharge current (8/20 $\mu$ s) ( $I_n$ )	20 kA
Cut-off frequency line-PG ( $f_G$ )	100 MHz
Approvals	UL, CSA, SIL, EAC



## BSP M2 BD HF 5 / 24

Space-saving surge arrester module for protecting one pair of high-frequency bus systems or video transmission systems with galvanic isolation.

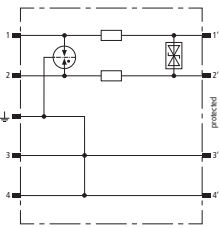

Type BSP ...	M2 BD HF 5	M2 BD HF 24
Part No.	926 271	926 275
SPD class	TYPE 2 P1	TYPE 2 P1
Max. continuous operating voltage (d.c.) ( $U_c$ )	6.0 V	33 V
Nominal current at 45 °C ( $I_n$ )	1.0 A	1.0 A
D1 Lightning impulse current (10/350 $\mu$ s) per line ( $I_{imp}$ )	1 kA	1 kA
C2 Total nominal discharge current (8/20 $\mu$ s) ( $I_n$ )	20 kA	20 kA
Cut-off frequency line-line ( $f_G$ )	100 MHz	100 MHz
Approvals	UL, CSA, SIL, EAC	UL, CSA, SIL, EAC



**BLITZDUCTOR® XT Ex (i)**

- Surge arrester for intrinsically safe measuring circuits and bus systems
  - Maximum discharge capacity for two-pole, three-pole or four-pole interfaces
  - Low voltage protection level, capable of protecting terminal equipment
  - Wide range of approvals: ATEX, IECEx, CSA Hazloc
- Arrester consists of a protection module and a base part
  - Easy replacement of protection modules without force
  - All protection components are integrated in the protection module
  - Arrester with integrated LifeCheck for preventive arrester monitoring
- Functional and appealing design
  - DIN rail mounted arrester with integrated earthing
  - Minimum space requirements, two pairs over a width of 12 mm
  - Vibration and shock-tested for safe operation

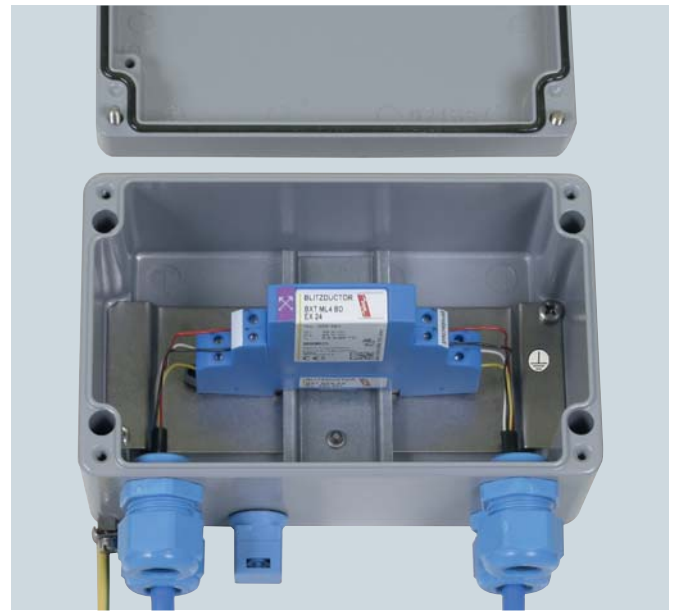

Pluggable and universal multipole surge arrester for use in intrinsically safe systems with integrated LifeCheck monitoring function.

BLITZDUCTOR XT EX is a pluggable and universal four-pole DIN rail mounted surge arrester designed for the most stringent requirements on the availability of intrinsically safe measuring and control circuits and bus systems.

Regarding intrinsic safety, the arrester is considered unearthed and its self-inductance and self-capacitance are negligibly small. The low-impedance arrester design ensures a high impulse current discharge capacity (at least 10x) and a low voltage protection level.

LifeCheck allows quick and easy arrester testing, however, the protection modules may only be read by the hand-held DRC LC reader in non-explosive atmospheres.

Integrated in the protection modules, LifeCheck permanently monitors the operating state of the arrester. Like an early warning system, LifeCheck

detects imminent electrical or thermal overload of the protection components. The LifeCheck status can be read in a second by the hand-held DEHNrecord LC reader via non-contact RFID technology. Moreover, the date of the last test of the protection module can be displayed and saved. Stationary installed, a condition monitoring system allows condition-based maintenance of 10 BXT arresters.

The arrester provides protection against vibration effects and shock up to a 30-fold acceleration of gravity. The function-optimised arrester design allows quick and easy replacement of protection modules which house all relevant protection elements.

The **protection module** and **base part** must be ordered separately!



Two-part design comprising a universal base part and an application-specific protection module.



The module locking mechanism ensures that the module is vibration-proof and protected against polarity reversal.

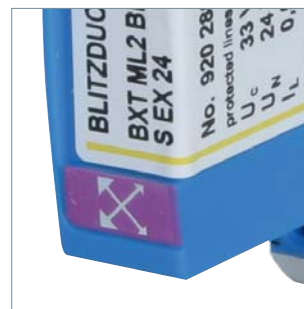

All protection elements are integrated in the plug-in module and are monitored by means of LifeCheck.



Prewired surge arrester unit ITAK EXI BXT 24.



**BLITZDUCTOR® XT Ex (i) – Base Part**

- BXT BAS EX – Base part without signal disconnection
- Universal base part for protection modules of the BLITZDUCTOR XT Ex (i) series
- No signal disconnection if the protection module is removed
- Connection of up to four lines

Pluggable SPDs –  
DIN Rail mounted



**BXT BAS EX**

BLITZDUCTOR XT base part for use as extremely space-saving and universal four-pole feed-through terminal for intrinsically safe circuits and for the insertion of the protection module without signal disconnection if the protection module is removed. The snap-in mechanism at the supporting foot of the base part allows the device to be safely earthed via the DIN rail. Since no components of the protective circuit are situated in the base part, maintenance operation is only required for the protection modules.

Type	BXT BAS EX
Part No.	920 301
For mounting on	35 mm DINs rails acc. to EN 60715
Cross-sectional area, solid	0.08-4 mm <sup>2</sup>
Cross-sectional area, flexible	0.08-2.5 mm <sup>2</sup>
Tightening torque (terminals)	0.4 Nm
Earthing via	35 mm DIN rails acc. to EN 60715
Approvals	UL, CSA, EAC Ex, ATEX, IECEx *)

\*) only in connection with an approved protection module

**BLITZDUCTOR® XT Ex (i) – Protection Modules with LifeCheck®**

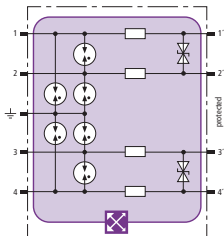

**BXT ML4 BD EX 24**

Space-saving LifeCheck-equipped surge arrester module for protecting two pairs in intrinsically safe measuring circuits and bus systems.

Type BXT ...	ML4 BD EX 24
Part No.	920 381
SPD class	TYPE 2 P1
Max. continuous operating voltage (d.c.) (U <sub>c</sub> )	33 V
Max. input current acc. to EN 60079-11 (I <sub>i</sub> )	0.5 A
D1 Total lightning impulse current (10/350 μs) (I <sub>imp</sub> )	4 kA
D1 Lightning impulse current (10/350 μs) per line (I <sub>imp</sub> )	1 kA
C2 Total nominal discharge current (8/20 μs) (I <sub>n</sub> )	20 kA
Cut-off frequency line-line (f <sub>c</sub> )	7.7 MHz
Approvals *)	CSA, EAC Ex, ATEX, IECEx, CSA & USA Hazloc, SIL

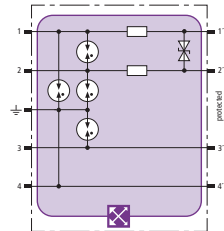

**BXT ML2 BD S EX 24**

Space-saving LifeCheck-equipped surge arrester module for protecting one pair in intrinsically safe measuring circuits and bus systems, direct or indirect shield earthing.

Type BXT ...	ML2 BD S EX 24
Part No.	920 280
SPD class	TYPE 2 P1
Max. continuous operating voltage (d.c.) (U <sub>c</sub> )	33 V
Max. input current acc. to EN 60079-11 (I <sub>i</sub> )	0.5 A
D1 Total lightning impulse current (10/350 μs) (I <sub>imp</sub> )	4 kA
D1 Lightning impulse current (10/350 μs) per line (I <sub>imp</sub> )	1 kA
C2 Total nominal discharge current (8/20 μs) (I <sub>n</sub> )	10 kA
Cut-off frequency line-line (f <sub>c</sub> )	6 MHz
Approvals *)	EAC Ex, ATEX, IECEx, CSA & USA Hazloc

\*) For details see: [www.dehn-international.com](http://www.dehn-international.com)

## Pluggable SPDs – DIN Rail mounted

### BXT ML4 BC EX 24

Space-saving LifeCheck-equipped surge arrester module for protecting up to four unearthed single lines sharing a common reference potential in intrinsically safe measuring circuits.

Type BXT ...	ML4 BC EX 24
Part No.	920 384
SPD class	TYPE 2 P1
Max. continuous operating voltage (d.c.) ( $U_c$ )	33 V
Max. input current acc. to EN 60079-11 ( $I_i$ )	0.5 A
D1 Total lightning impulse current (10/350 $\mu$ s) ( $I_{imp}$ )	4 kA
D1 Lightning impulse current (10/350 $\mu$ s) per line ( $I_{imp}$ )	1 kA
C2 Total nominal discharge current (8/20 $\mu$ s) ( $I_n$ )	20 kA
Cut-off frequency line-line ( $f_G$ )	6.4 MHz
Approvals *)	CSA, EAC Ex, ATEX, IECEx, CSA & USA Hazloc, SIL

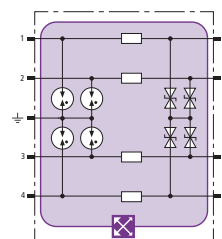

Pluggable SPDs –  
DIN Rail mounted

### BXT ML2 BD HF EX 6

Space-saving LifeCheck-equipped surge arrester module for protecting intrinsically safe measuring circuits and RS485 bus systems.

Type BXT ...	ML2 BD HF EX 6
Part No.	920 538
SPD class	TYPE 2 P1
Max. continuous operating voltage (d.c.) ( $U_c$ )	6 V
Max. input current acc. to EN 60079-11 ( $I_i$ )	4.8 A
D1 Lightning impulse current (10/350 $\mu$ s) per line ( $I_{imp}$ )	1 kA
C2 Total nominal discharge current (8/20 $\mu$ s) ( $I_n$ )	10 kA
Cut-off frequency line-line ( $f_G$ )	100 MHz
Approvals *)	EAC Ex, ATEX, IECEx, CSA & USA Hazloc, SIL

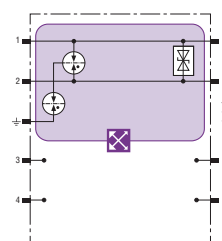

## BLITZDUCTOR® XT Ex (i) – Protection Modules

### BXT M2 BD S EX 24

Space-saving surge arrester module for protecting one pair in intrinsically safe measuring circuits and bus systems, direct or indirect shield earthing.

Type BXT ...	M2 BD S EX 24
Part No.	920 383
SPD class	TYPE 2 P1
Max. continuous operating voltage (d.c.) ( $U_c$ )	36 V
Max. input current acc. to EN 60079-11 ( $I_i$ )	0.5 A
D1 Total lightning impulse current (10/350 $\mu$ s) ( $I_{imp}$ )	4 kA
D1 Lightning impulse current (10/350 $\mu$ s) per line ( $I_{imp}$ )	1 kA
C2 Total nominal discharge current (8/20 $\mu$ s) ( $I_n$ )	10 kA
Cut-off frequency line-line ( $f_G$ )	7.7 MHz
Approvals *)	CSA, ATEX, IECEx, CSA & USA Hazloc, SIL

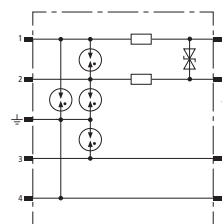

\*) For details see: [www.dehn-international.com](http://www.dehn-international.com)

## Accessories for BLITZDUCTOR® XT Ex (i)

### Partition

Allows to position devices of the BXT family for non-intrinsically safe circuits directly next to intrinsically safe circuits (thread measure  $\geq 50$  mm).

For DRC MCM XT and DRC SCM XT; 1 set = 2 pieces.

Type	TW DRC MCM EX
Part No.	910 697
For mounting on	35 mm DIN rails according to EN 60715



ITAK Ex (i)

Pluggable SPDs –  
DIN Rail mounted



**ITAK EXI BXT**

BXT ML4 BD EX 24 and BXT BAS EX completely mounted. ATEX, FISCO.

Type	ITAK EXI BXT 24
Part No.	989 408
SPD class	TYPE 2 P1
Max. continuous operating voltage (d.c.) (U <sub>c</sub> )	33 V
Max. input current acc. EN 60079-11 (I <sub>i</sub> )	0.5 A
Total nominal discharge current (8/20 μs) (I <sub>n</sub> )	20 kA
Cut-off frequency line-line (f <sub>G</sub> )	7.7 MHz
Degree of protection	IP 65
Approvals for installed BXT	CSA, EAC Ex, ATEX, IECEx, CSA & USA Hazloc, SIL

Accessories for ITAK Ex (i)

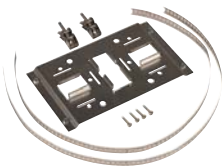

**Mounting Set**

For fixing ALGA 5 X enclosures at masts and pipes.

Type	MS ALGA 5 X
Part No.	906 059
Enclosure material	StSt

Accessories for BLITZDUCTOR® XT/XTU/SP/XT Ex (i)

**Earthing Module**

The plugged-in earthing module connects all lines connected to the BLITZDUCTOR SP/XT/XTU base part to the equipotential bonding. It directly earths unused cable cores that are already connected to the base part.



Type	BXT M4 E
Part No.	920 308
D1 Total lightning impulse current (10/350 μs) (I <sub>imp</sub> )	10 kA
Plugs into	base part

**Test / Disconnection Module**

The plugged-in test / disconnection module interrupts the cable run of the lines connected to the BLITZDUCTOR SP/XT/XTU base part and leads them to a test socket at the front of the module. This allows to carry out measurements in the installation without removing the lines from the base part.



Type	BXT M4 T
Part No.	920 309
Max. continuous operating voltage (d.c.) (U <sub>c</sub> )	180 V
Nominal current at 80 °C (I <sub>N</sub> )	1.0 A
Volume resistance	0.1 ohms
Plugs into	base part
Test sockets	gold-plated, 1 mm
Accessories	2 measuring lines (1 m), protective bag

**Measuring Line for BXT M4 T**

Spare part / extension for test / disconnection modules. Only suitable for use with BXT M4 T test / disconnection modules. 1 set = 2 measuring lines.



Type	ML BXT M4 T
Part No.	920 394
Length	1000 mm

**Labelling System BA1-BA15**

2x 165 adhesive labels for labelling DRC MCM XT monitoring devices with the bus address (BA1 to BA15) and BXT modules with consecutive numbers (1.1-1.10 to 15.1-15.10).

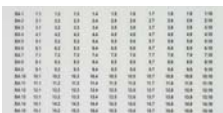

Type	BS BA1 BA15 BXT
Part No.	920 398
Dimensions (W x H)	13 x 7 mm



### EMC Spring Terminals

Two spring terminals for the protected and unprotected side of a BLITZDUCTOR BSP/XT/XTU arrester for permanent low-impedance shield contact with a shielded signal line. Insulating cap for indirect shield earthing (BXT only), cable ties and insulating strips included. Suitable for BXT(U) ML2 ...S ... / BSP M2 ... types (direct shield earthing only).

Type	SAK BXT LR
Part No.	920 395
D1 Lightning impulse current (10/350 µs)	5 kA
Plugs into	terminal BXT BAS / BSP BAS 4
Accessories	insulating caps, cable tie, insulating strips



### DRC MCM XT

DIN rail mounted device with integrated LifeCheck sensor for condition monitoring of max. 10 LifeCheck-equipped BXT/BXTU arresters. An RS 485 interface allows to interconnect up to 15 DRC MCM XT.

Type	DRC MCM XT
Part No.	910 695
Colour	grey



### DRC SCM XT

DIN rail mounted device with integrated LifeCheck sensor for condition monitoring of max. 10 LifeCheck-equipped BXT/BXTU arresters.

Type	DRC SCM XT
Part No.	910 696
Colour	grey



### DRC LC M3+

Portable device with LifeCheck sensor for flexible use. Fast and easy testing of LifeCheck-equipped arresters. Documentation via PC database.

Type	DRC LC M3+
Part No.	910 653
Dimensions of storage case	340 x 275 x 83 mm



### DRC LC M1+

Portable device with LifeCheck sensor for flexible use. Fast and easy testing of LifeCheck-equipped arresters.

Type	DRC LC M1+
Part No.	910 655
Dimensions of storage case	275 x 230 x 83 mm



### LifeCheck Sensor for DRC BXT

Snap-on LifeCheck sensor and test module for use as spare part / extension for portable LifeCheck test devices.

Type	LCS DRC BXT
Part No.	910 652
For testing	BLITZDUCTOR XT ML



### DIN Rail mounted Power Supply Unit

High-performance DIN rail mounted power supply unit with single-phase wide-range input can be connected to different supply systems. The operating state indicator on the front panel indicates whether the output voltage is present. Up to 10 DRC MCM XT or DRC SCM XT (single application) or up to 15 DRC MCM XT (multiple application) monitoring devices can be connected to a single power supply unit.

Type	PSU DC24 30W
Part No.	910 499
Nominal input voltage (U <sub>e</sub> )	100 V ... 240 V a.c.
Nominal output voltage (U <sub>a</sub> )	24 V d.c. (SELV)



### USB Interface Converter of Type USB-NANO-485







USB-Nano-485 converts between USB and RS485 signals and is specifically designed for two-wire RS-485 buses. LEDs indicate the operating state (yellow), Rx (green) and Tx (red). Due to its compact dimensions, USB-Nano-485 is ideally suited for use with notebooks, however, stationary use is also possible.

Type	USB NANO 485
Part No.	910 486
Version	with LED indication









**BLITZDUCTOR® XT/XTU – List of Approvals (as of January 2016)**

Pluggable SPDs –  
DIN Rail mounted

Part No.	Type	ATEX 	IECEX 	CSA-Hazloc 	SIL (up to SIL3)	UL 	CSA 	EAC 
920 211	BXT ML2 B 180	●(1)	●(2)	●(5)	●		●	●
920 220	BXT ML2 BE S 5	●(1)	●(2)	●(5)	●		●	●
920 222	BXT ML2 BE S 12	●(1)	●(2)	●(5)	●		●	●
920 224	BXT ML2 BE S 24	●(1)	●(2)	●(5)	●		●	●
920 225	BXT ML2 BE S 48	●(1)	●(2)	●(5)	●	●	●	●
920 226	BXT ML2 BE S 36					●		●
920 240	BXT ML2 BD S 5	●(1)	●(2)	●(5)	●		●	●
920 242	BXT ML2 BD S 12	●(1)	●(2)	●(5)	●		●	●
920 243	BXT ML2 BD DL S 15	●(1)	●(2)	●(5)	●			●
920 244	BXT ML2 BD S 24	●(1)	●(2)	●(5)	●		●	●
920 245	BXT ML2 BD S 48	●(1)	●(2)	●(5)	●		●	●
920 247	BXT ML2 BD 180	●(1)	●(2)	●(5)	●		●	●
920 270	BXT ML2 BE HFS 5	●(1)	●(2)	●(5)	●	●	●	●
920 271	BXT ML2 BD HFS 5	●(1)	●(2)	●(5)	●	●	●	●
920 288	BXT ML2 MY E 110							●
920 289	BXT ML2 MY 250							●
920 310	BXT ML4 B 180	●(1)	●(2)	●(5)	●		●	●
920 314	BXT ML4 BPD 24				●			
920 320	BXT ML4 BE 5	●(1)	●(2)	●(5)	●	●	●	●
920 322	BXT ML4 BE 12	●(1)	●(2)	●(5)	●	●	●	●
920 324	BXT ML4 BE 24	●(1)	●(2)	●(5)	●	●	●	●
920 325	BXT ML4 BE 48	●(1)	●(2)	●(5)	●	●	●	●
920 326	BXT ML4 BE 60	●(1)	●(2)	●(5)	●	●	●	●
920 327	BXT ML4 BE 180	●(1)	●(2)	●(5)	●	●	●	●
920 336	BXT ML4 BE 36	●(1)	●(2)	●(5)	●	●		●
920 340	BXT ML4 BD 5	●(1)	●(2)	●(5)	●	●	●	●
920 342	BXT ML4 BD 12	●(1)	●(2)	●(5)	●	●	●	●
920 344	BXT ML4 BD 24	●(1)	●(2)	●(5)	●	●	●	●
920 345	BXT ML4 BD 48	●(1)	●(2)	●(5)	●	●	●	●
920 346	BXT ML4 BD 60	●(1)	●(2)	●(5)	●	●	●	●
920 347	BXT ML4 BD 180	●(1)	●(2)	●(5)	●	●	●	●
920 350	BXT ML4 BC 5	●(1)	●(2)	●(5)	●		●	●
920 354	BXT ML4 BC 24	●(1)	●(2)	●(5)	●		●	●
920 362	BXT ML4 BE C 12	●(1)	●(2)	●(5)	●			●
920 364	BXT ML4 BE C 24	●(1)	●(2)	●(5)	●		●	●
920 370	BXT ML4 BE HF 5	●(1)	●(2)	●(5)	●	●	●	●
920 371	BXT ML4 BD HF 5	●(1)	●(2)	●(5)	●	●	●	●
920 375	BXT ML4 BD HF 24	●(1)	●(2)	●(5)	●	●	●	●
920 388	BXT ML4 MY 110							●
920 389	BXT ML4 MY 250				●			●
920 280	BXT ML2 BD S EX 24	●(3)	●(4)	●(6)				●(11)
920 381	BXT ML4 BD EX 24	●(3)	●(4)	●(6)	●		●	●(10)
920 384	BXT ML4 BC EX 24	●(3)	●(4)	●(6)	●		●	●(10)
920 538	BXT ML2 BD HF EX 6	●(3)	●(4)	●(6)	●			●(11)
920 383	BXT M2 BD S EX 24	●(9)	●(8)	●(7)				
920 249	BXTU ML2 BD S 0-180				●	●	●	●
920 349	BXTU ML4 BD 0-180				●	●	●	●

For more detailed information on approvals and SIL, please visit [www.dehn-international.com](http://www.dehn-international.com).

**BLITZDUCTOR® SP – List of Approvals (as of January 2016)**

Part No.	Type	ATEX 	IECEX 	CSA-Hazloc 	SIL (up to SIL3)	UL 	CSA 	EAC 
926 220	BSP M2 BE 5				•	•		•
926 222	BSP M2 BE 12				•	•		•
926 224	BSP M2 BE 24				•	•		•
926 225	BSP M2 BE 48				•	•		•
926 226	BSP M2 BE 60				•	•		•
926 227	BSP M2 BE 180				•	•		•
926 240	BSP M2 BD 5				•	•		•
926 242	BSP M2 BD 12				•	•		•
926 244	BSP M2 BD 24				•	•		•
926 245	BSP M2 BD 48				•	•		•
926 246	BSP M2 BD 60				•	•		•
926 247	BSP M2 BD 180				•	•		•
926 270	BSP M2 BE HF 5				•	•		•
926 271	BSP M2 BD HF 5				•	•		•
926 275	BSP M2 BD HF 24					•		•
926 320	BSP M4 BE 5				•	•		•
926 322	BSP M4 BE 12				•	•		•
926 324	BSP M4 BE 24				•	•		•
926 325	BSP M4 BE 48				•	•		•
926 326	BSP M4 BE 60				•	•		•
926 327	BSP M4 BE 180				•	•		•
926 340	BSP M4 BD 5				•	•		•
926 342	BSP M4 BD 12				•	•		•
926 344	BSP M4 BD 24				•	•		•
926 345	BSP M4 BD 48				•	•		•
926 346	BSP M4 BD 60				•	•		•
926 347	BSP M4 BD 180				•	•		•
926 370	BSP M4 BE HF 5				•	•		•
926 371	BSP M4 BD HF 5				•	•		•
926 375	BSP M4 BD HF 24					•		•

Pluggable SPDs –  
DIN Rail mounted

(1)	DEKRA 11ATEX0089 X: II 3 G Ex nA IIC T4 Gc
(2)	DEK 11.0032X: Ex nA IIC T4 Gc
(3)	KEMA 06ATEX0274 X: II 2(1) G Ex ia [ia Ga] IIC T4 ... T6 Gb KEMA 06ATEX0274 X: II 2 G Ex ib IIC T4 ... T6 Gb
(4)	DEK 11.0078 X: Ex ia [ia Ga] IIC T4 ... T6 Gb DEK 11.0078 X: Ex ib IIC T4, T5, T6 Gb
(5)	CSA 2516389: Class I Div. 2 GP A, B, C, D T4 CSA 2516389: Class I Zone 2, AEx nA IIC T4
(6)	CSA 12.70000011: IS, Class I, Zone 1, AEx ia [ia] IIC T4 ... T6 CSA 12.70000011: IS, Class I, Div 1, Group A, B, C, D, T4 ... T6 CSA 12.70000011: Ex ia [ia] IIC T4...T6 Gb

(7)	CSA 2392869: IS, Class I, Div. 1, GP A, B, C, D T4 ... T6 CSA 2392869: IS, Class I, Zone 1, AEx ia IIC T4 ... T6 CSA 2392869: Ex ia IIC T4...T6 CSA 2392869: Class I Div. 2, GP A,B,C,D T4 ... T6 CSA 2392869: Class I, Zone 2, AEx nA IIC T4 ... T6 CSA 2392869: Ex nA IIC T4...T6
(8)	KEM 09.0077X: Ex ia [ia Ga] IIC T4 ... T6 Gb KEM 09.0077X: Ex ic IIC T4...T6 Gc KEM 09.0077X: Ex nA IIC T4...T6 Gc
(9)	KEMA 09ATEX0177 X: II 3 G Ex ic IIC T4 ... T6 Gc KEMA 09ATEX0177 X: II 3 G Ex nA IIC T4 ... T6 Gc KEMA 09ATEX0178 X: II 2(1) G Ex ia [ia Ga] IIC T4 ... T6 Gb
(10)	EAC TC RU C-DE.GB06.B00505 0 Ex ia IIC T4 ... T6
(11)	EAC TC RU C-DE.GB06.B00505 1 Ex ib IIC T4 ... T6

For more detailed information on approvals and SIL, please visit [www.dehn-international.com](http://www.dehn-international.com).

DEHN protects.





## DEHNconnect SD2

- Terminal block with integrated surge protection
  - For protecting measuring and control circuits and bus systems
  - Maximum impulse current carrying capability  $I_{max}$  up to 20 kA (8/20  $\mu$ s)
  - Low voltage protection level, capable of protecting terminal equipment
- Modular disconnection function
  - Disconnection module for disconnecting the signal circuit for maintenance work
  - Module fixing and mechanical ejector
  - Module in “parked” position after disconnection
- Space-saving and function-optimised design
  - Terminal block with integrated surge protection (width of 6 mm)
  - Fast conductor connection without tools thanks to spring-loaded connection system
  - Can be used with jumper bar (accessory)

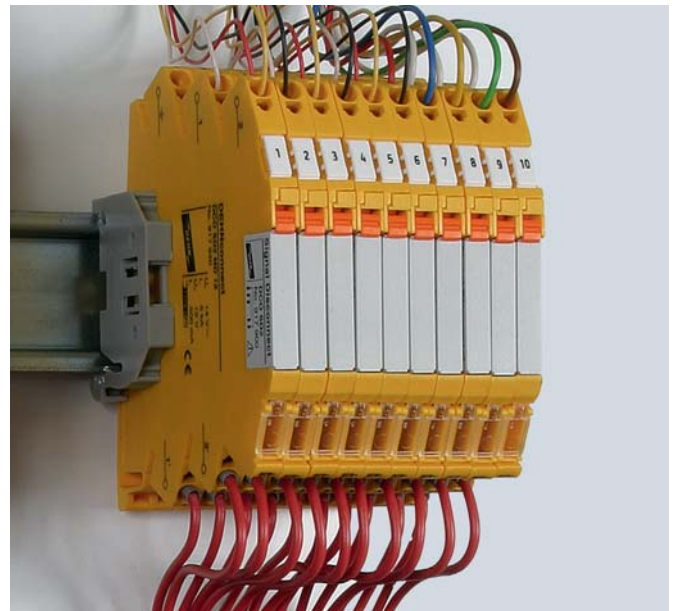

Application example: DEHNconnect for protecting the I/O of PLC interfaces.

The surge arresters of the DEHNconnect SD2 series are designed as space-saving terminal blocks with a width of 6 mm. These terminal blocks with integrated surge protection have a modular disconnection function that allows them to interrupt the signal circuit for maintenance work. An integrated module ejector disconnects the signal circuit from the terminal equipment. The disconnection module does not have to be removed, but remains in a “parked” position in the module slot.

Different types of arresters are available and protect two single lines sharing a common reference potential (unbalanced interfaces) or an unearthed pair (balanced interface). Arresters with a high cut-off frequency (HF) can be used for balanced bus interfaces with high data rates (e.g. Profibus, RS485).

Conductors are connected via a vibration-proof spring-loaded connection system. Stripped solid conductors and flexible conductors with wire end ferrule can be easily and quickly inserted into the relevant conductor terminal without the use of tools. For rewiring, the conductor is removed from the clamping point and clamped into a new conductor terminal.

To reduce wiring, jumper bars can be inserted at the protected side of the surge arrester, thus quickly connecting signal circuits.

The arresters are ideally suited for use in industrial environments at information technology signal interfaces of automation, measuring and control as well as bus systems.



Disconnection module with ejector – for disconnecting the signal circuits.

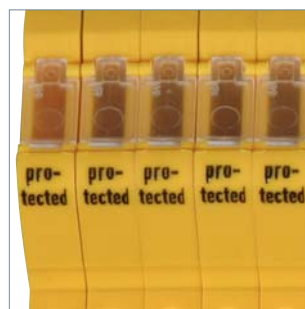

Marking of the protected side – minimises wiring errors.

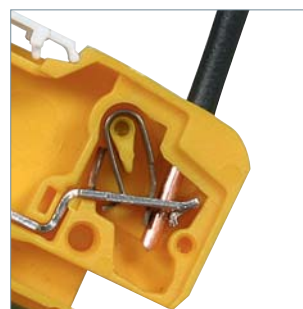

Spring-loaded connection system – fast and vibration-proof connection.

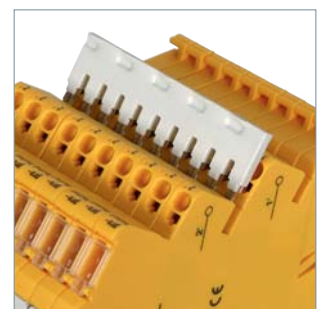

Slots for jumper bars – for quickly connecting signal circuits.

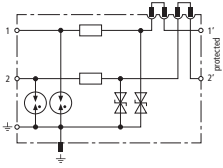

**DCO SD2 ME**

Energy-coordinated surge arrester with disconnection function for protecting two single lines sharing a common reference potential as well as unbalanced interfaces.

Type DCO SD2 ...	ME 12	ME 24	ME 48
Part No.	917 920	917 921	917 922
SPD class	TYPE 2 P1	TYPE 2 P1	TYPE 2 P1
Max. continuous operating voltage (d.c.) (U <sub>c</sub> )	14 V	33 V	55 V
Nominal current at 80 °C (I <sub>n</sub> )	0.5 A	0.5 A	0.5 A
D1 Lightning impulse current (10/350 μs) per line (I <sub>imp</sub> )	1 kA	1 kA	1 kA
C2 Total nominal discharge current (8/20 μs) (I <sub>n</sub> )	10 kA	10 kA	10 kA
Cut-off frequency line-PG (f <sub>c</sub> )	2.5 MHz	6 MHz	7.5 MHz
Approvals	UL, CSA, SIL, EAC	UL, CSA, SIL, EAC	UL, CSA, SIL, EAC

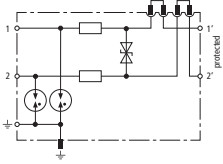

**DCO SD2 MD**

Energy-coordinated surge arrester with disconnection function for protecting one unearthed pair as well as balanced interfaces.

Type DCO SD2 ...	MD 12	MD 24	MD 48
Part No.	917 940	917 941	917 942
SPD class	TYPE 2 P1	TYPE 2 P1	TYPE 2 P1
Max. continuous operating voltage (d.c.) (U <sub>c</sub> )	14 V	33 V	55 V
Nominal current at 80 °C (I <sub>n</sub> )	0.5 A	0.5 A	0.5 A
D1 Lightning impulse current (10/350 μs) per line (I <sub>imp</sub> )	1 kA	1 kA	1 kA
C2 Total nominal discharge current (8/20 μs) (I <sub>n</sub> )	10 kA	10 kA	10 kA
Cut-off frequency line-PG (f <sub>c</sub> )	2.5 MHz	6 MHz	8 MHz
Approvals	UL, CSA, SIL, EAC	UL, CSA, SIL, EAC	UL, CSA, SIL, EAC

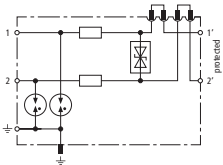

**DCO SD2 MD HF**

Energy-coordinated surge arrester with disconnection function for protecting balanced interfaces with extra-low voltages. Also suitable for high transmission rates.

Type DCO SD2 ...	MD HF 5
Part No.	917 970
SPD class	TYPE 2 P1
Max. continuous operating voltage (d.c.) (U <sub>c</sub> )	8.5 V
Nominal current at 80 °C (I <sub>n</sub> )	0.5 A
D1 Lightning impulse current (10/350 μs) per line (I <sub>imp</sub> )	1 kA
C2 Total nominal discharge current (8/20 μs) (I <sub>n</sub> )	10 kA
Cut-off frequency line-line (f <sub>c</sub> )	100 MHz
Approvals	UL, CSA, SIL, EAC

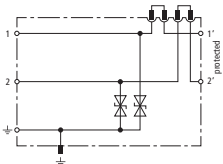

**DCO SD2 E**

Finely-limiting surge protective device with disconnection function for two single lines sharing a common reference potential and unbalanced interfaces.

Type DCO SD2 ...	E 12	E 24	E 48
Part No.	917 987	917 988	917 989
SPD class	TYPE 3 P1	TYPE 3 P1	TYPE 4 P1
Max. continuous operating voltage (d.c.) (U <sub>c</sub> )	13 V	28 V	58 V
Nominal current at 60 °C (I <sub>n</sub> )	10 A	10 A	10 A
C1 Total nominal discharge current (8/20 μs) (I <sub>n</sub> )	0.8 kA	0.6 kA	0.3 kA
Cut-off frequency line-PG (f <sub>c</sub> )	2.3 MHz	5.5 MHz	8.7 MHz
Approvals	UL, CSA, SIL, EAC	UL, CSA, SIL, EAC	UL, CSA, SIL, EAC



## DEHNconnect SD2 Ex (i)

- Terminal block with integrated surge protection
  - For protecting intrinsically safe measuring and control circuits and bus systems (Ex (i))
  - Maximum impulse current carrying capability  $I_{max}$  up to 20 kA (8/20  $\mu$ s)
  - Low voltage protection level, also suitable for terminal equipment
  - Approvals: ATEX, IECEx
- Modular disconnection function
  - Disconnection module for disconnecting the signal circuit for maintenance work
  - Module fixing and mechanical ejector
  - Module in “parked” position after disconnection
- Space-saving and function-optimised design
  - Terminal block with integrated surge protection (width of 6 mm)
  - Fast and safe conductor connection thanks to spring-loaded connection system
  - Can be used with jumper bar (accessory)



Arrester group for protecting intrinsically safe measuring circuits

The surge arresters of the DEHNconnect SD2 series are designed as space-saving terminal blocks with a width of 6 mm. These terminal blocks with integrated surge protection have a modular disconnection function that allows them to disconnect the signal circuit for maintenance work. An integrated module ejector disconnects the signal circuit from the terminal equipment. The disconnection module does not have to be removed, but remains in a “parked” position in the module slot.

DEHNconnect SD2 Ex (i) is designed for intrinsically safe measuring and control circuits and bus systems and protects one unearthed pair (balanced interface).

Conductors are connected via a vibration-proof spring-loaded connection system. Stripped solid conductors and flexible conductors with wire end ferrule can be easily and quickly inserted into the relevant conductor terminal without the use of tools. For rewiring, the conductor is removed from the clamping point and clamped into a new conductor terminal.

To reduce wiring, jumper bars can be inserted at the protected side of the surge arrester, thus quickly connecting signal circuits.

The arresters are ideally suited for use in the process industry to protect Ex (i) measuring circuits and interfaces for bus communication (e.g. Fieldbus Foundation or Profibus PA).



Disconnection module with ejector – for disconnecting the signal circuits.



Marking of the protected side – minimises wiring errors.

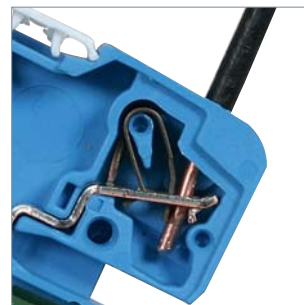

Spring-loaded connection system – fast and vibration-proof connection without tools.



Slots for jumper bars – for quickly connecting signal circuits.

### DCO SD2 MD EX

Surge arrester for protecting intrinsically safe measuring circuits and bus systems.

Type	DCO SD2 MD EX 24
Part No.	917 960
SPD class	TYPE 2 P1
Max. continuous operating voltage (d.c.) ( $U_c$ )	33 V
Max. input current according to EN 60079-11 ( $I_i$ )	0.5 A
D1 Lightning impulse current (10/350 $\mu$ s) per line ( $I_{imp}$ )	1 kA
C2 Total nominal discharge current (8/20 $\mu$ s) ( $I_n$ )	10 kA
Cut-off frequency line-line ( $f_c$ )	5.8 MHz
Approvals	UL, CSA, EAC Ex, ATEX, IECEx, SIL

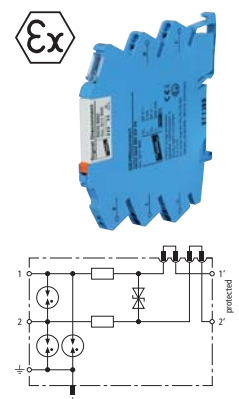

## Accessories DEHNconnect SD2

## Signal Disconnect Disconnection Module (Spare Part)

Disconnection module (spare part) to be plugged into DCO SD2 for disconnecting the signal in the system circuit.



Type	DCO SD2
Part No.	917 900
Width	6 mm

## Jumper Bar

Multipole jumper bar for DCO SD2 terminal blocks with integrated surge protection.



Type	KB 10 DCO RK
Part No.	919 880
Poles	10

## Quick Labelling System, horizontal Imprint

Plate with 2x plate numbers from 1 to 50 for DCO SD2, horizontal imprint.



Type	LS 1 50 H DCO
Part No.	917 977
Material	plastic

## Quick Labelling System, vertical Imprint

Plate with 2x plate numbers from 1 to 50 for DCO SD2, vertical imprint.



Type	LS 1 50 V DCO
Part No.	917 976
Material	plastic





**DEHNvario**

- Compact terminals ensure easy and fast installation
- Direct plug-in technology allows connection without tools
- Fast arrester replacement by simply releasing and removing the terminal unit
- Earthing / equipotential bonding via DIN rail



Protection of the loudspeaker outputs of a voice alarm system.

Compact SPDs –  
DIN Rail mounted

Arresters of the DEHNvario product line are lightning current and surge arresters in a compact DIN rail mounted enclosure. The innovative enclosure design provides maximum functionality on minimum space.

The conductors can be easily connected without tools thanks to the terminal with direct plug-in technology. The spring-loaded terminals apply a defined pressure on the conductors which automatically equalises any deformation of connected conductors and prevents self-loosening of the wires. The plugged-in conductors can be easily released at the push of a button and individually removed from the relevant terminal.

The terminal unit is snapped into the enclosure and is thus vibration-proof in all environmental conditions. Easy and fast arrester replacement is ensured by removing the terminal unit from the enclosure using an unlocking tool or screw driver. Thus there is no need to disconnect the cores individually. Thanks to the integrated test openings in the terminal units, the signal circuit can be tested efficiently even when wired. The signal lines can be contacted by means of a test pin (max. diameter of 1 mm).

The lightning current carrying earth contact allows the arresters to be easily connected to the equipotential bonding via the DIN rail.



Direct plug-in technology ensures easy conductor connection without tools.



Fast arrester replacement by simply removing the terminal unit.



Integrated test openings for testing the signal circuit by means of a test pin.



Lightning current carrying earth contact.

**DVR 2 BY S 150 FM**

Compact combined arrester for protecting electroacoustic systems (e.g. voice alarm systems, loudspeaker systems). Protection of one galvanically isolated pair; direct or indirect shield earthing. Direct plug-in technology allows fast installation without tools. Easy replacement of the arrester is ensured by the integrated terminal units which can be released and then removed from the enclosure. Integrated remote signalling contact (break contact).

Type	DVR 2 BY S 150 FM
Part No.	928 430 <small>NEW</small>
SPD class	TYPE 1 P2
Max. continuous operating voltage (d.c.) (U <sub>c</sub> )	150 V
Nominal current at 70 °C (I <sub>n</sub> )	10 A
Nominal current at 80 °C (I <sub>n</sub> )	7 A
D1 Lightning impulse current (10/350 µs) per line (I <sub>imp</sub> )	2.5 kA
C2 Total nominal discharge current (8/20 µs) (I <sub>n</sub> )	22.5 kA
Cut-off frequency line-line (f <sub>c</sub> )	1.4 MHz
Approvals	EAC

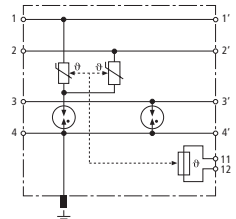



**BLITZDUCTOR® VT**



Compact DIN rail mounted surge protective device with screw terminals for multi-core lines.

- Cost-effective protection of multi-core signal lines
- Interface-specific versions, e.g. TTY, RS485, telecommunication systems
- Versions for d.c. power supply systems

Compact SPDs –  
DIN Rail mounted

BLITZDUCTOR VT is a family of compact DIN rail mounted arresters and consists of different types of enclosures with different connection methods. Both devices for protecting four-wire signal interfaces with screw connections, but also devices for protecting terminal equipment of telecommunication systems as well as telephone systems with RJ connection

are for example available. All types can be mounted on DIN rails and are earthed via a screw terminal.

BLITZDUCTOR VT has a variable enclosure concept. Depending on the application, different types of arresters are available.



BVT enclosure type with a width of 1.5 modules and screw terminals:

BVT AV/LD: Two protected lines for d.c. power supply systems

BVT (M)TTY: Four protected signal cores



BVT enclosure type with a width of 3 modules and screw terminals: BVT RS485 specifically designed for protecting RS485/RS422 interfaces.



BVT enclosure type with a width of 1.5 modules and RJ connection: BVT TC1 and BVT ISDN for protecting telecommunication interfaces.



Separate earth connection on the unprotected side of the device. The second slot of the double terminal is intended for connecting the terminal equipment to the equipotential bonding.

## BVT TTY

Energy-coordinated protection for four-wire optocoupler interfaces with additional decoupling resistor at the output.

Type BVT ...	TTY 24
Part No.	918 400
SPD class	TYPE 2 Pt
Max. continuous operating voltage (d.c.) ( $U_c$ )	26.8 V
Nominal current ( $I_L$ )	0.1 A
D1 Lightning impulse current (10/350 $\mu$ s) per line ( $I_{imp}$ )	0.8 kA
C2 Total nominal discharge current (8/20 $\mu$ s) ( $I_n$ )	10 kA
Series resistance per line	17.2 ohms per pair
Cut-off frequency line-line ( $f_c$ )	8 MHz
Approvals	CSA, EAC

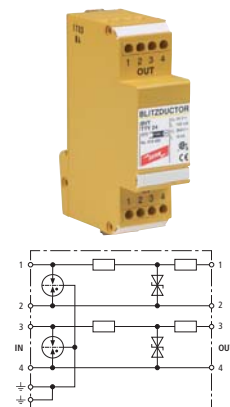

## BVT MTTY

Energy-coordinated surge arrester, no leakage currents to earth, for two unearthed pairs.

Type BVT ...	MTTY 24
Part No.	918 407
SPD class	TYPE 2 Pt
Max. continuous operating voltage (d.c.) ( $U_c$ )	26.8 V
Nominal current ( $I_L$ )	0.1 A
D1 Lightning impulse current (10/350 $\mu$ s) per line ( $I_{imp}$ )	0.8 kA
C2 Total nominal discharge current (8/20 $\mu$ s) ( $I_n$ )	20 kA
Series resistance per line	2.2 ohms per pair
Cut-off frequency line-line ( $f_c$ )	10 MHz
Approvals	EAC

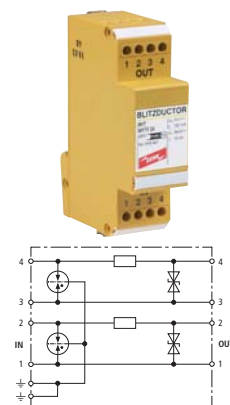

## BVT RS485

Protection for balanced four-wire RS485/422 interfaces, direct or indirect shield earthing, connection of a signal ground.

Type BVT ...	RS485 5
Part No.	918 401
SPD class	TYPE 2 Pt
Max. continuous operating voltage (d.c.) ( $U_c$ )	6 V
Nominal current ( $I_L$ )	0.5 A
D1 Lightning impulse current (10/350 $\mu$ s) per line ( $I_{imp}$ )	0.8 kA
C2 Total nominal discharge current (8/20 $\mu$ s) ( $I_n$ )	10 kA
Series resistance per line	1.8 ohms
Cut-off frequency line-line ( $f_c$ )	1.7 MHz
Approvals	CSA, EAC

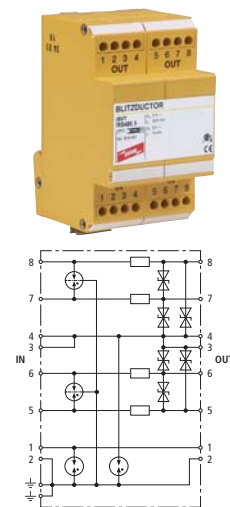

## BVT AVD

Surge arrester with improved voltage protection levels for EMC protection of electronic components with d.c. voltage supply. Ideally suited for Siemens PLCs.

Type BVT ...	AVD 24
Part No.	918 422
SPD class	TYPE 3 Pt
Max. continuous operating voltage (d.c.) ( $U_c$ )	35 V
Nominal current at 80 °C ( $I_L$ )	10 A
C2 Total nominal discharge current (8/20 $\mu$ s) ( $I_n$ )	2 kA
Approvals	EAC

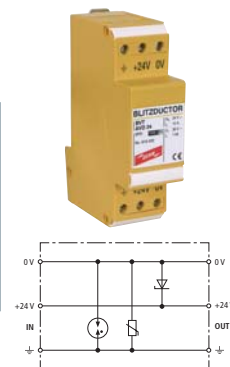

Compact SPDs –  
DIN Rail mounted

**BVT ALD**

Energy-coordinated, DIN rail mounted combined lightning current and surge arrester for protecting unearthed d.c. power supply systems.

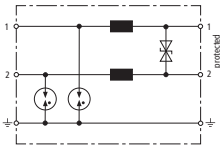

Type BVT ...	ALD 36	ALD 60
Part No.	918 408	918 409
SPD class	TYPE 1P1	TYPE 1P1
Max. continuous operating voltage (d.c.) ( $U_C$ )	45 V	65 V
Nominal current at 80 °C ( $I_L$ )	4 A	4 A
Nominal current at 45 °C ( $I_L$ )	7 A	7 A
Backup fuse if	—	$U_N \geq 45$ V and $I_L \geq 1$ A
D1 Lightning impulse current (10/350 $\mu$ s) per line ( $I_{imp}$ )	2.5 kA	2.5 kA
D1 Total lightning impulse current (10/350 $\mu$ s) ( $I_{imp}$ )	5 kA	5 kA
C2 Total nominal discharge current (8/20 $\mu$ s) ( $I_n$ )	20 kA	20 kA
Series resistance per line	22 $\mu$ H	22 $\mu$ H
Approvals	EAC	EAC

**BVT ISDN**

Energy-coordinated surge arrester for the ISDN  $S_0$  bus with RJ45 connections and additional screw terminal at the protected output.

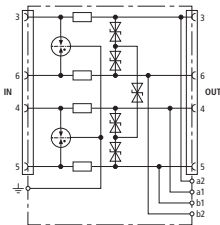

Type BVT ...	ISDN
Part No.	918 410
SPD class	TYPE 2P1
Max. continuous operating voltage (d.c.) ( $U_C$ )	7.5 V
Max. continuous operating voltage (d.c.) pair-pair ( $U_C$ )	60 V
Nominal current ( $I_L$ )	0.2 A
D1 Lightning impulse current (10/350 $\mu$ s) per line ( $I_{imp}$ )	1 kA
C2 Total nominal discharge current (8/20 $\mu$ s) ( $I_n$ )	10 kA
Series resistance per line	1.0 ohm
Cut-off frequency line-line ( $f_G$ )	1.7 MHz
Approvals	EAC

**BVT TC**

Energy-coordinated leakage-current-free surge arrester for a/b lines, ISDN  $U_{k0}$  or ADSL with RJ45 connections and additional screw terminals. Compatible with RJ11/12.

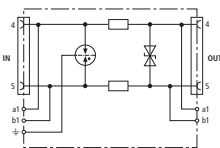

Type BVT ...	TC 1
Part No.	918 411
SPD class	TYPE 2P2
Max. continuous operating voltage (d.c.) ( $U_C$ )	170 V
Nominal current ( $I_L$ )	0.2 A
D1 Lightning impulse current (10/350 $\mu$ s) per line ( $I_{imp}$ )	1 kA
C2 Total nominal discharge current (8/20 $\mu$ s) ( $I_n$ )	5 kA
Series resistance per line	4.7 ohms
Cut-off frequency line-line ( $f_G$ )	17 MHz
Approvals	EAC

Compact SPDs –  
DIN Rail mounted



**BLITZDUCTOR® VT KKS**

Combined lightning current and surge arrester for cathodic protection systems

- Extremely efficient thanks to high discharge capacity
- Easy maintenance due to remote signalling contact
- Resistant to permanent interference voltages up to 65 V a.c.

The protective circuit and voltage measuring circuit are protected against surges caused by atmospheric discharges (lightning strikes) or switching operations (in power supply lines).

The devices are designed for permanent interference voltages up to 65 V a.c. between pipelines and earth. If this value is exceeded, the relevant regulations concerning protection against electric shock have to be observed and further measures have to be taken.

The devices may be overloaded by overcurrents as a result of mains faults (short-circuits or earth faults). For this reason, they should be installed in a separate metal enclosure or a prewired terminal unit (ITAK) should be used. The integrated remote signalling contact indicates thermal overload of the discharge paths.

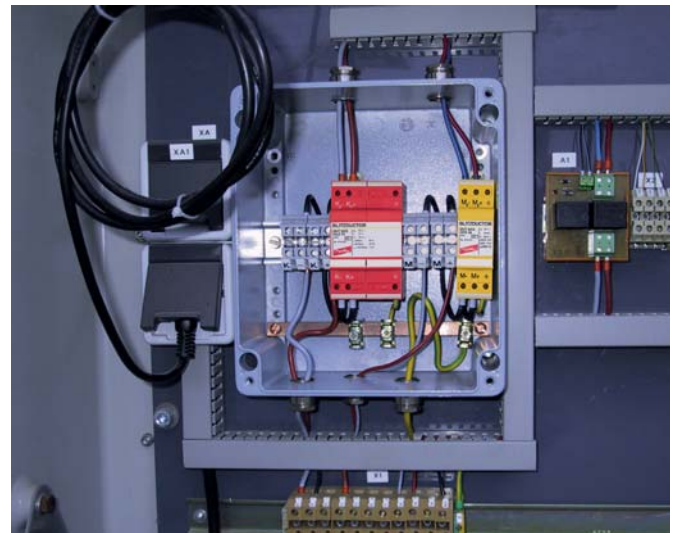

Arrester for protecting active cathodic protection systems. Integrated floating remote signalling contact (break contact) monitors the function of the arrester.

Compact SPDs –  
DIN Rail mounted



Different arresters for the protective circuit (red) and voltage measuring circuit (yellow).



The arresters for cathodic corrosion protection are equipped with a remote signalling contact.



Prewired unit (ITAK) for cathodic corrosion protection consisting of an arrester in a metal enclosure which protects the protective circuit and voltage measuring circuit.  
Ordering designation: ITAK, serial No. 4305.

**BVT KKS ALD**

Protection of anode circuits up to 10 A. Installation into steel-sheet enclosure recommended.

Type BVT KKS ...	<b>ALD 75</b>
Part No.	<b>918 420</b>
SPD class	<b>TYPE 1 PI</b>
Max. continuous operating voltage (d.c.) ( $U_c$ )	75 V
Nominal current ( $I_n$ )	12 A
D1 Total lightning impulse current (10/350 $\mu$ s) ( $I_{imp}$ )	7 kA
C2 Total nominal discharge current (8/20 $\mu$ s) ( $I_n$ )	40 kA
Series resistance per line	5 $\mu$ H
Approvals	EAC
Type of remote signalling contact	break contact

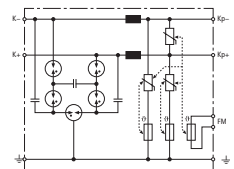

**BVT KKS APD**

Protection of sensor measuring circuits. With integrated overcurrent element. Installation into steel-sheet enclosure recommended.

Type BVT KKS ...	<b>APD 36</b>
Part No.	<b>918 421</b>
SPD class	<b>TYPE 1 PI</b>
Max. continuous operating voltage (d.c.) ( $U_c$ )	36.8 V
Nominal current ( $I_n$ )	0.05 A
D1 Total lightning impulse current (10/350 $\mu$ s) ( $I_{imp}$ )	7 kA
C2 Total nominal discharge current (8/20 $\mu$ s) ( $I_n$ )	40 kA
Series resistance per line	55 ohms
Approvals	EAC
Type of remote signalling contact	break contact

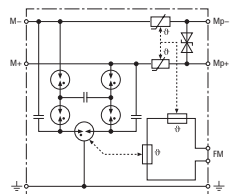



DEHN protects.

Product	Description	Type	Part No.	Page
<b>Lightning current / surge arresters</b>				
	<ul style="list-style-type: none"> <li>– Lightning current carrying DRL plug-in SPD block can be easily plugged into LSA disconnection blocks of 2/10 type</li> <li>– Versions with / without fail-safe function / visual indication</li> <li>– Modularly expandable with a DRL protective plug to a combined lightning current and surge arrester</li> <li>– With integrated disconnection block contacts</li> </ul>	<b>DRL 10 B 180</b> <b>DRL 10 B 180 FSD</b>	<b>907 400</b> <b>907 401</b>	<b>175</b> <b>175</b>
	<ul style="list-style-type: none"> <li>– Protective plug for one pair inserted through the earthing frame into the DRL plug-in SPD block</li> <li>– Energy-coordinated with DRL plug-in SPD block</li> <li>– Low voltage protection level for application-specific protection of terminal equipment</li> </ul>	<b>DRL ...</b>	<b>907 420</b> – <b>907 470</b>	<b>175</b> – <b>176</b>
	<ul style="list-style-type: none"> <li>– Snap-on earthing frame for earthing and mounting DRL protective plugs on a 10-pair disconnection block or the lightning current carrying DRL plug-in SPD block</li> </ul>	<b>EF 10 DRL</b>	<b>907 498</b>	<b>177</b>
<b>Surge arresters</b>				
	<ul style="list-style-type: none"> <li>– Powerful SPD block can be easily plugged into LSA disconnection blocks of 2/10 type</li> <li>– Versions with / without fail-safe function / visual indication</li> </ul>	<b>DPL 10 G3 110</b> <b>DPL 10 G3 110 FSD</b>	<b>907 214</b> <b>907 216</b>	<b>178</b> <b>178</b>
<b>DEHN enclosure for equipotential bonding</b>				
	<ul style="list-style-type: none"> <li>– Lightning current carrying earthing system for arresters and shield connection</li> <li>– Pre-mounted mounting frame</li> <li>– Lockable enclosure</li> </ul>	<b>DPG LSA ... P</b>	<b>906 100</b> – <b>906 103</b>	<b>180</b>
<b>Routing module for disconnection blocks with LSA spring-loaded terminal</b>				
	<ul style="list-style-type: none"> <li>– DIN rail mounted routing module for disconnection blocks</li> <li>– Equipped with LSA disconnection block and spring-loaded terminals for variable wire connection</li> <li>– Routing of different wire diameters</li> </ul>	<b>TL2 10DA CC</b>	<b>907 991</b>	<b>182</b>



**DEHNrapid® LSA – Lightning Current / Surge Arrester**



- Variable protection for 1 to 10 pairs in LSA systems of the 2/10 series
- LSA disconnection block function integrated in the lightning current arrester allows for protected testing, disconnecting and patching
- Modular system of lightning current and surge arresters can be combined to a single combined arrester

The DEHNrapid LSA arrester series is a modular system of lightning current arresters, surge arresters or combined lightning current and surge arresters that can be plugged into LSA disconnection blocks of series 2. The lightning current carrying 10-pair plug-in SPD block incorporates gas discharge tubes (optionally available with visual fault indication) and disconnection block contacts. This allows testing, disconnecting or patching of pairs with plugged-in protection or the additional attachment of single-pair surge arresters to ensure optimal protection of terminal equipment. The surge arresters snap into the earthing frame and can be removed as a block, whenever required.

SPDs for LSA Technology

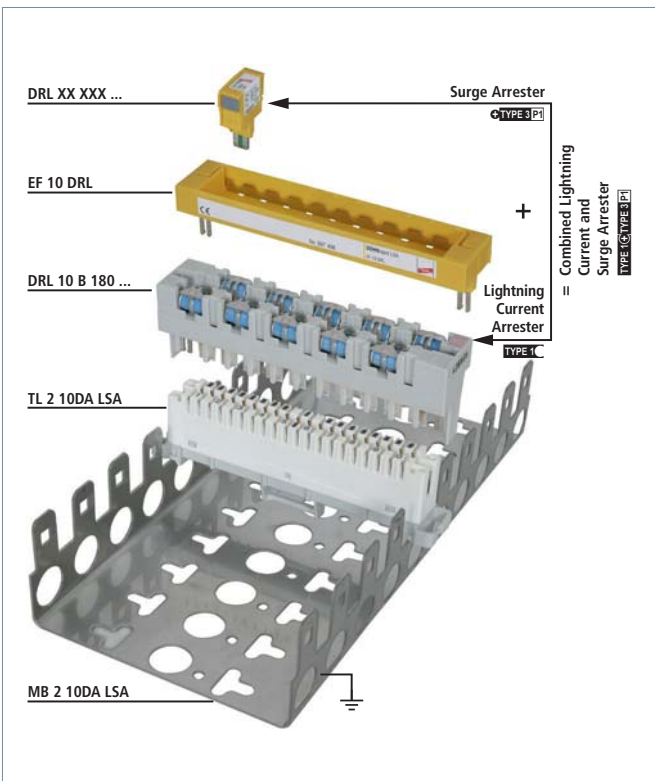

Modular design consisting of a plug-in SPD block with gas discharge tubes, earthing frame and application-specific protection modules.



Combined lightning current and surge arrester for LSA terminal blocks.



Lightning current carrying SPD block with gas discharge tubes optionally available with visual fault indication and fail-safe function.



Application-specific protection modules for protecting terminal equipment.



Pluggable surge arresters in the form of protection blocks can be plugged into terminal or disconnection blocks.



**DRL 10 B**

Lightning current carrying DRL plug-in SPD block (10 pairs), expandable with DRL protective plug. Integrated disconnection block contacts allow protected testing, measuring and patching.

Type DRL ...	<b>10 B 180</b>
Part No.	<b>907 400</b>
SPD class	<b>TYPE C</b>
Max. continuous operating voltage (d.c.) ( $U_c$ )	180 V
Nominal current ( $I_L$ )	0.4 A
D1 Total lightning impulse current (10/350 $\mu$ s) ( $I_{imp}$ )	5 kA
C2 Total nominal discharge current (8/20 $\mu$ s) ( $I_n$ )	10 kA
Series resistance per line	$\leq 0.005$ ohms
Plugs into	LSA disconnection block 2/10
Approvals	VdS, EAC

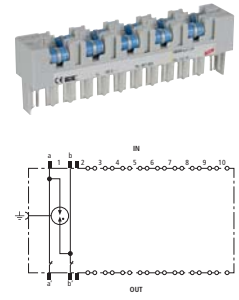

**DRL 10 B FSD**

Lightning current carrying DRL plug-in SPD block (10 pairs), expandable with DRL protective plug. Integrated disconnection block contacts allow protected testing, measuring and patching. Arrester with fail-safe function and visual fault indication.

Type DRL ...	<b>10 B 180 FSD</b>
Part No.	<b>907 401</b>
SPD class	<b>TYPE C</b>
Fault indication	visual, colour change
Max. continuous operating voltage (d.c.) ( $U_c$ )	180 V
Nominal current ( $I_L$ )	0.4 A
D1 Total lightning impulse current (10/350 $\mu$ s) ( $I_{imp}$ )	5 kA
C2 Total nominal discharge current (8/20 $\mu$ s) ( $I_n$ )	10 kA
Series resistance per line	$\leq 0.005$ ohms
Plugs into	LSA disconnection block 2/10
Approvals	VdS, EAC

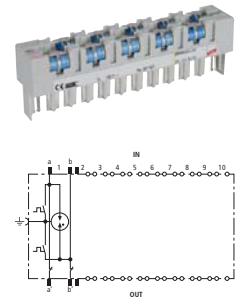

SPDs for LSA Technology

**DRL RE**

Single-stage protective plug (one pair) for signal circuits sharing a common potential. Earthing via EF 10 DRL. For disconnection blocks or DRL plug-in SPD blocks only.

<b>General technical data:</b>	
SPD class	<b>TYPE B PI</b>
D1 Total lightning impulse current (10/350 $\mu$ s) in combination with DRL 10 B... ( $I_{imp}$ )	5 kA
C2 Total nominal discharge current (8/20 $\mu$ s) in combination with DRL 10 B... ( $I_n$ )	10 kA
Plugs into	LSA disconnection block 2/10 or DRL 10 B ... plug-in SPD block
Approvals	VdS, EAC

Type DRL ...	<b>RE 5</b>	<b>RE 12</b>	<b>RE 24</b>
Part No.	<b>907 420</b>	<b>907 421</b>	<b>907 422</b>
Max. continuous operating voltage (d.c.) ( $U_c$ )	6 V	14 V	28 V
Nominal current ( $I_L$ )	0.4 A	0.4 A	0.4 A
Series resistance per line	4.7 ohms	4.7 ohms	4.7 ohms
Cut-off frequency line-PG ( $f_G$ )	0.95 MHz	2.7 MHz	4.5 MHz

Type DRL ...	<b>RE 48</b>	<b>RE 60</b>	<b>RE 180</b>
Part No.	<b>907 423</b>	<b>907 424</b>	<b>907 425</b>
Max. continuous operating voltage (d.c.) ( $U_c$ )	54 V	70 V	180 V
Nominal current ( $I_L$ )	0.4 A	0.4 A	0.1 A
Series resistance per line	6.8 ohms	6.8 ohms	4.7 ohms
Cut-off frequency line-PG ( $f_G$ )	7.35 MHz	10.5 MHz	42 MHz

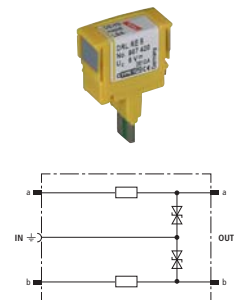

**DRL RD**

Single-stage protective plug (one pair) for galvanically isolated interfaces. To be mounted into EF 10 DRL. Installation recommended only in combination with the DRL plug-in SPD block.

General technical data:	
SPD class	⚡TYPE 3 P1
Nominal current (I <sub>n</sub> )	0.4 A
D1 Total lightning impulse current (10/350 μs) in combination with DRL 10 B... (I <sub>imp</sub> )	5 kA
C2 Total nominal discharge current (8/20 μs) in combination with DRL 10 B... (I <sub>n</sub> )	10 kA
Plugs into	LSA disconnection block 2/10 or DRL 10 B... plug-in SPD block

Type DRL ...	RD 5	RD 12	RD 24
Part No.	907 440	907 441	907 442
Max. continuous operating voltage (d.c.) (U <sub>c</sub> )	6 V	14 V	28 V
Series resistance per line	2.2 ohms	2.2 ohms	2.2 ohms
Cut-off frequency line-line (f <sub>G</sub> )	1 MHz	2.7 MHz	5.4 MHz
Approvals	VdS, EAC	VdS, EAC	VdS, EAC

Type DRL ...	RD 48	RD 60	RD 110
Part No.	907 443	907 444	907 445
Max. continuous operating voltage (d.c.) (U <sub>c</sub> )	54 V	70 V	180 V
Series resistance per line	4.7 ohms	4.7 ohms	4.7 ohms
Cut-off frequency line-line (f <sub>G</sub> )	7.8 MHz	11 MHz	20 MHz
Approvals	VdS, EAC	VdS, EAC	EAC

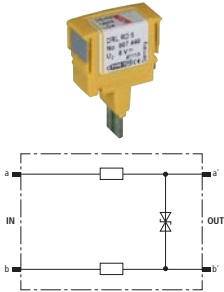

**DRL PD**

Single-stage protective plug with overcurrent protection (one pair) for ADSL, ISDN U<sub>k0</sub> or a/b lines. To be mounted into EF 10 DRL. Installation recommended only in combination with DRL plug-in SPD block.

Type DRL ...	PD 180
Part No.	907 430
SPD class	⚡TYPE 3 P1
Max. continuous operating voltage (d.c.) (U <sub>c</sub> )	180 V
Nominal current (I <sub>n</sub> )	0.1 A
D1 Total lightning impulse current (10/350 μs) in combination with DRL 10 B... (I <sub>imp</sub> )	5 kA
C2 Total nominal discharge current (8/20 μs) in combination with DRL 10 B... (I <sub>n</sub> )	10 kA
Series resistance per line	10 ohms +/- 15%
Cut-off frequency line-line (f <sub>G</sub> )	61 MHz
Plugs into	LSA disconnection block 2/10 or DRL 10 B... plug-in SPD block
Approvals	VdS, EAC

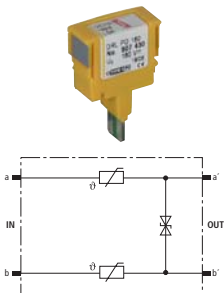

**DRL HD**

Single-stage protective plug (1 pair) for high-frequency transmissions such as G.703 or ISDN U<sub>2m</sub>, S<sub>2m</sub> and S<sub>0</sub>. HD 5 type for RS 485 bus systems. To be mounted into EF 10 DRL. Installation recommended only in combination with DRL plug-in SPD block.

Type DRL ...	HD 5	HD 24
Part No.	907 465	907 470
SPD class	⚡TYPE 3 P1	⚡TYPE 3 P1
Max. continuous operating voltage (d.c.) (U <sub>c</sub> )	6.5 V	28 V
Nominal current (I <sub>n</sub> )	0.4 A	0.4 A
D1 Total lightning impulse current (10/350 μs) in combination with DRL 10 B... (I <sub>imp</sub> )	5 kA	5 kA
C2 Total nominal discharge current (8/20 μs) in combination with DRL 10 B... (I <sub>n</sub> )	10 kA	10 kA
Series resistance per line	2.2 ohms	4.7 ohms
Cut-off frequency line-line (f <sub>G</sub> )	90 MHz	94 MHz
Plugs into	LSA disconnection block 2/10 or DRL 10 B... plug-in SPD block	
Approvals	EAC	VdS, EAC

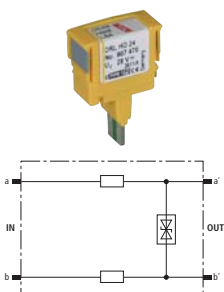

SPDs for LSA Technology



## Accessories for DEHNrapid® LSA

### Plug-in SPD Block (without SPDs)

Plug-in SPD block (without SPDs) for 1 to max. 10 three-pole GDT 230 B3 ... gas discharge tubes. Also suitable for DRL protective plugs with earthing frame.

Type	BM 10 DRL
Part No.	907 499
Plugs into	LSA disconnection blocks
Earthing via	mounting frame



### Gas Discharge Tube

High-capacity replacement gas discharge tube for DRL 10 or BM 10 DRL. Three-pole version with common arcing chamber for a constant voltage protection level line-line and line-ground.

Type	GDT 230 B3 FSD
Part No.	907 219
Integrated into Part No.	907 401
Visual fault indication	yes
Fail-safe spring	yes
D1 Total lightning impulse current (10/350 µs)	5 kA



### Gas Discharge Tube

High-capacity replacement gas discharge tubes for DRL 10 or BM 10 DRL. Three-pole version with common arcing chamber for a constant voltage protection level line-line and line-ground.

Type	GDT 230 B3
Part No.	907 218
Integrated into Part No.	907 400
D1 Total lightning impulse current (10/350 µs)	5 kA



### Earthing Frame

Snap-on earthing frame for earthing and installation of max. 10 DRL protection modules. Plugs into a 10-pair disconnection block or DRL plug-in SPD block.

Type	EF 10 DRL
Part No.	907 498
Plugs into	LSA disconnection blocks or DRL plug-in SPD block
Earthing via	mounting frame or DRL plug-in SPD block



### Label Holder

Universal label holder made of stainless steel for clear identification of LSA connections. Can be snapped onto DEHNrapid LSA plug-in SPD blocks, earthing frames with protective plugs or mounting frames with LSA blocks of the 2/10 series.

Type	SR DRL
Part No.	907 497
Plugs into	DRL B, EF DRL, LSA blocks 2/10 (profile, with earth connecting clip)



### Earthing Module

Earthing plug for directly connecting two unused lines to the equipotential bonding system.

Type	EM 2 DRL
Part No.	907 496
D1 Total lightning impulse current (10/350 µs)	5 kA
Plugs into	TL2 10DA ...
Earthing via	EF 10 DRL
Material	zinc die-casting
Approvals	EAC





## DPL 10 G3

Pluggable arresters for use in LSA systems of the 2/10 series.  
For use as protection block for 10 pairs with individually exchangeable protection elements.

## DPL 10 G3

Plug-in SPD block for ten pairs with three-pole gas discharge tubes for almost all applications. FSD arresters feature a fail-safe function and an additional visual indication when the fail-safe function has been activated. Thus it can be immediately identified whether an arrester has to be replaced.



Type DPL 10 G3 ...	110	110 FSD
Part No.	907 214	907 216
SPD class	TYPE 2	TYPE 2
Fault indication	—	colour change
Max. continuous operating voltage (d.c.) ( $U_c$ )	180 V	180 V
Nominal current ( $I_n$ )	0.4 A	0.4 A
C2 Total nominal discharge current (8/20 $\mu$ s) ( $I_n$ )	10 kA	10 kA
Approvals	EAC	EAC

## Accessories for DPL 10 G3

## Gas Discharge Tube

High-capacity replacement gas discharge tubes for DPL 10 G3. Three-pole version with common arcing chamber for a constant voltage protection level line-line and line-ground.



Type	GDT 230 G3	GDT 230 G3 FSD
Part No.	907 208	907 217
Integrated into Part No.	907 214	907 216
Visual fault indication	—	yes
Fail-safe spring	—	yes



## DEHN Enclosure for Equipotential Bonding

- Premounted enclosure system for wiring and protection components
- Tested lightning impulse current carrying capacity
- Optimised for equipotential bonding (surge arresters and shield connection)
- Lockable metal enclosure to prevent against unauthorised access

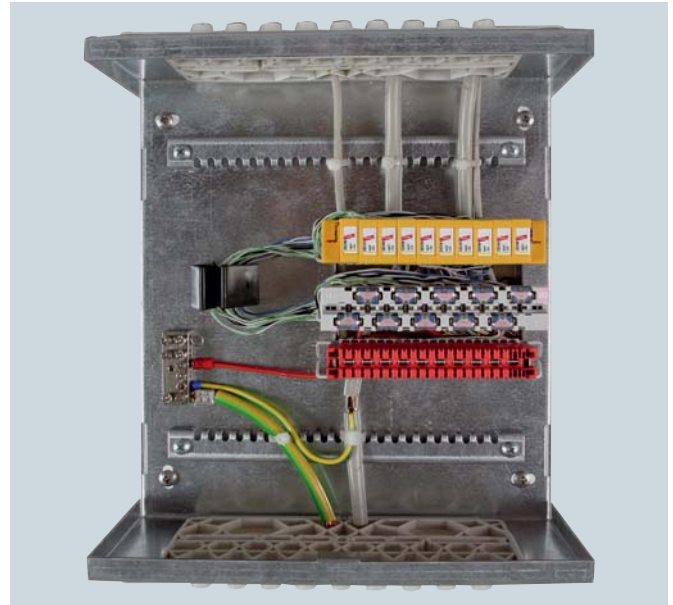

DEHN enclosures for equipotential bonding (DPG) are lockable metal enclosures for installation of wiring and protection components. Available in four different sizes, the lightning current carrying enclosures provide terminals that allow to integrate surge arresters and shields into the equipotential bonding system.

Lightning current carrying enclosure with IP 40 degree of protection for different distribution board designs and for the insertion of surge arresters. The cover can be removed from the wall plate without tools and features a lock with cylinder quarter turn and a key. The C-shaped design of the wall plate allows side and front access during installation work. LSA mounting frames or DIN rails can be mounted on the wall plate with cable entry plates and cable rails.

Despite a high packing density, structured cable management is ensured – crossing of cables with wires is avoided and the cables of e.g. the LSA blocks are clearly structured due to the 30 mm grid dimensions. For this kind of cabling, an optional shield connection system is available (constant force spring). The well-conceived earthing system permanently connects all conductive components of the enclosure system to the earthing block via mechanical contact or earthing conductors.



DEHN enclosures for equipotential bonding (DPG) come in different sizes, allowing the insertion of 3/6/12/22 LSA blocks. Even if 20/50/100/200 pairs are connected, enough space is provided for the earthing plug for inserting the earth drain wires.



All equipotential bonding conductors are led together in the central earthing block.

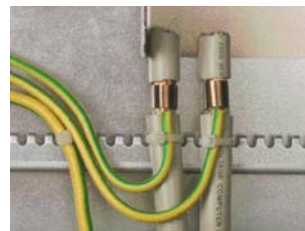

The shields of incoming lines can be contacted with SA KRF constant force springs in a space-saving and lightning-current-carrying way.



The enclosure for equipotential bonding can be locked (key supplied with the enclosure).

**DPG LSA**

DPG LSA is a completely premounted enclosure system with LSA mounting frame and allows optimised use of arresters and shield connection systems (constant force spring).



Type DPG LSA ...	30 P	60 P	120 P	220 P
Part No.	906 100	906 101	906 102	906 103
Carrying capacity of connection elements D1 Total lightning impulse current (10/350 µs) (I <sub>imp</sub> )	15 kA	30 kA	50 kA	50 kA
LSA mounting frame for	1x 3 blocks 2/10	1x 6 blocks 2/10	2x 6 blocks 2/10	2x 11 blocks 2/10
Wire guides	1 pc(s).	2 pc(s).	2 pc(s).	3 pc(s).
Degree of protection	IP 40	IP 40	IP 40	IP 40
Dimensions W x H x D	240 x 260 x 130 mm	240 x 350 x 130 mm	330 x 350 x 130 mm	330 x 500 x 130 mm

**Accessories for DEHN Enclosure for Equipotential Bonding**

**Self-bonding Rubber Tape**

Roll with 9 m self-bonding rubber tape to be wrapped around constant force springs for permanent corrosion protection.



Type	SKB 19 9M SW
Part No.	919 030
Colour	black ●

**Constant Force Spring**

Constant force springs allow solderless shield connections for equipotential bonding or lightning equipotential bonding. They can be installed subsequently without interrupting the cable shield or requiring tools for installation. Approved for nuclear installations according to TÜV Certificate No. T12-04-ETL003 (TÜV = German Technical Inspectorate).

General technical data:			
Material	StSt		
Type	SA KRF 10 V2A	SA KRF 15 V2A	SA KRF 22 V2A
Part No.	919 031	919 032	919 033
Clamping range	4-10 mm	9-15 mm	14-22 mm
Type	SA KRF 29 V2A		SA KRF 37 V2A
Part No.	919 034		919 035
Clamping range	18.5-29 mm		23.5-37 mm





## Accessories for LSA Technology

- Proven insulation displacement method
- 45° angled blades in the disconnection block ensure a lower change in cross-section
- Enhanced stability of the conductor
- Enhanced corrosion resistance
- Further accessories available on request

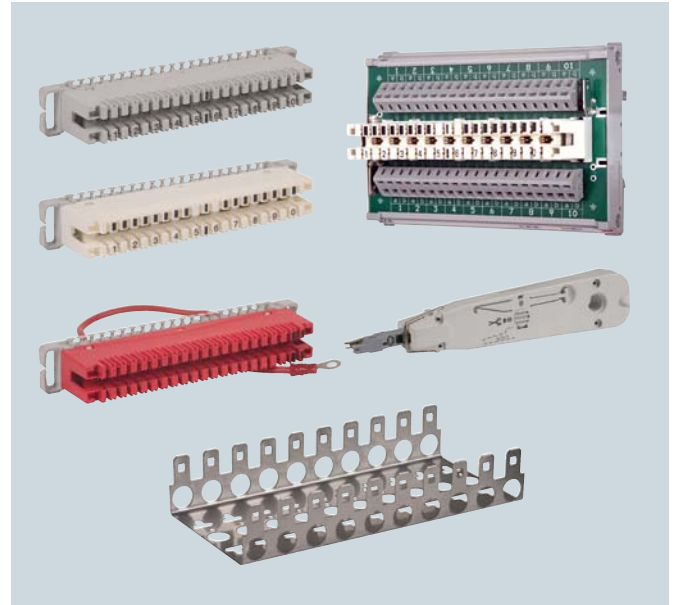

The insulation displacement method is used for quickly connecting several lines at reasonable costs. This method is commonly used in the telecommunications sector (e.g. Deutsche Telekom AG).

The blocks are suitable for connecting plastic-insulated wires with copper conductor material:

Conductor diameter: 0.4-0.8 mm  
Outer diameter: 0.7-1.5 mm

After using wires with a conductor diameter of 0.65 mm, rewiring to smaller diameters is no longer possible.

### Mounting Frame

Mounting frame for 10 LSA blocks series 2.  
Total width: 104.5 mm

Type	MB2 10 LSA
Part No.	907 995
Dimensions	223 x 105 x 42 mm



### Insertion Tool

Insertion tool with sensor for LSA technology for connecting the wires and simultaneously cutting them to the required length. With fold-out extraction hook and blade.

Type	AW2 LSA
Part No.	907 994
Colour	white



### Terminal Block

Series 2 for LSA technology for inseparably connecting 10 pairs each on the cable and routing side. Accommodates DPL 10 G3 arresters. Parallel protective circuit only.

Type	AL2 10DA LSA
Part No.	907 997
Test standards	DIN 47608-1, -2
Diameter of solid conductors	0.40-0.80 mm
Conductor diameter with insulation	0.70-1.50 mm



**Disconnection Block**

Series 2 for LSA technology for connecting 10 pairs each on the cable and routing side. Protection is provided between the disconnection contacts as soon as DRL components are plugged in. DPL 10 G3 arresters can also be plugged into the disconnection block.



Type	TL2 10DA LSA
Part No.	907 996
Test standards	DIN 47608-1, -2
Approvals	compliance with DTAG TS 0272/96
Diameter of solid conductors	0.40-0.80 mm
Conductor diameter with insulation	0.70-1.50 mm

**Earthing Plug**

Series 2 for LSA technology for connecting up to 38 earth drain wires or unused signal cores. With earth wire and M4 ring cable lug.



Type	EL2 38EA LSA
Part No.	907 993
Earthing via	earthing conductor with M4 ring cable lug
Diameter of solid conductors	0.40 - 0.80 mm
Conductor diameter with insulation	0.70 - 1.50 mm
Colour	red

**Routing Module for Disconnection Blocks with LSA spring-loaded Terminal**











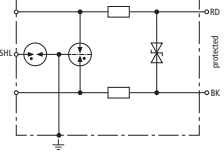

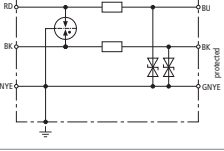

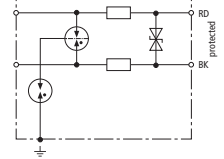

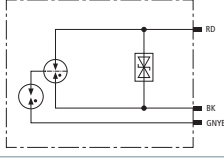
DIN rail mounted routing module with LSA disconnection block of the 2/10 series as well as spring-loaded terminals for variable wire connection. DPL and DEHNrapid LSA surge arresters can be plugged into the routing module.

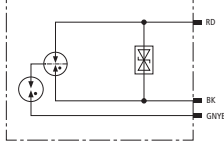

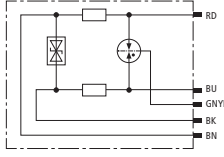
Type	TL2 10DA CC
Part No.	907 991
Carrying capacity of connection components D1 Total lightning impulse current (10/350 $\mu$ s) ( $I_{imp}$ )	5 kA
For mounting on	35 mm DIN rails acc. to EN 60715
Connection (input / output)	spring or LSA / spring or LSA
Earthing via	DIN rail / flat connector 6.3 mm
Diameter of solid conductors	0.40-0.80 mm
Conductor diameter with insulation	0.70-1.60 mm

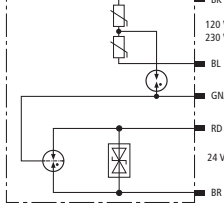

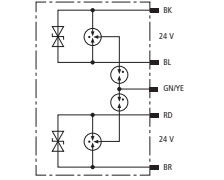
## SPDs for Field Devices

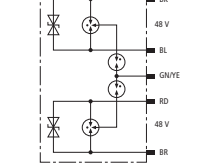
Product	Basic circuit diagram	Type	Part No.	Page
<b>DEHNpipe MD / ME</b>				
		<b>DPI MD</b> <ul style="list-style-type: none"> <li>For one balanced interface</li> <li>Direct or indirect shield earthing</li> <li>Nominal voltage: 24 V</li> <li>For series connection</li> <li>With M20 x 1.5 thread (female/male)</li> </ul>	929 941	184
		<b>DPI ME</b> <ul style="list-style-type: none"> <li>For one unbalanced interface</li> <li>Nominal voltage: 24 V</li> <li>For series connection</li> <li>With 1/2-14 NPT thread (male/male)</li> </ul>	929 921	185
<b>DEHNpipe MD Ex (i)</b>				
		<b>DPI MD EX</b> <ul style="list-style-type: none"> <li>For one balanced interface</li> <li>Nominal voltage: 24 V</li> <li>For series connection</li> <li>With M20 x 1.5 thread</li> </ul>	929 960	185
<b>DEHNpipe CD Ex (i)</b>				
		<b>DPI CD EXI</b> <ul style="list-style-type: none"> <li>For one balanced interface</li> <li>Nominal voltage: 24 V</li> <li>For parallel connection</li> <li>With M20 x 1.5 or 1/2-14 NPT thread</li> </ul>	929 961 929 963	185 185
<b>DEHNpipe CD Ex (d)</b>				
		<b>DPI CD EXD 24</b> <ul style="list-style-type: none"> <li>For one balanced interface</li> <li>Nominal voltage: 24 V</li> <li>For parallel connection</li> <li>With M20 x 1.5 or 1/2-14 NPT thread</li> </ul>	929 962 929 964	185 185
		<b>DPI CD HF EXD 5</b> <ul style="list-style-type: none"> <li>For one balanced interface</li> <li>Nominal voltage: 5 V</li> <li>For series connection</li> <li>With M20 x 1.5 thread</li> </ul>	929 971	186
		<b>DPI CD EXD 230 24</b> <ul style="list-style-type: none"> <li>For one balanced interface and one 120/230 V power supply system</li> <li>Nominal voltage: 24 V and 120/230 V</li> <li>For parallel connection</li> <li>With M20 x 1.5 or 1/2-14 NPT thread</li> </ul>	929 969 929 970	186 186
<b>DEHNpipe CD Ex (i) + Ex (d)</b>				
		<b>DPI CD EXI+D 2x24</b> <ul style="list-style-type: none"> <li>For two balanced interfaces</li> <li>Nominal voltage: 24 V</li> <li>For parallel connection</li> <li>With M20 x 1.5 or 1/2-14 NPT thread</li> </ul>	929 950 929 951	186 186
		<b>DPI CD EXI+D 2x48</b> <ul style="list-style-type: none"> <li>For two balanced interfaces</li> <li>Nominal voltage: 48 V</li> <li>For parallel connection</li> <li>With M20 x 1.5 or 1/2-14 NPT thread</li> </ul>	929 952 929 953	186 186



DEHNpipe



Surge arrester for outdoor use to be screwed onto two-wire field devices. Stainless steel, installation with cable gland up to IP 67.

- Surge arresters to be screwed onto field devices
  - Parallel or series connection
  - Made of corrosion-resistant stainless steel
  - Arrester for protecting a second interface (data or power side) available
- Types for Ex (i) and Ex (d) applications
  - For protecting intrinsically safe measuring circuits and bus systems Ex (i)
  - Type in a flameproof enclosure Ex (d)
- Variety of approvals
  - Approvals depending on the arrester: IECEx, ATEX, FISCO, CSA Hazloc

The devices of the DEHNpipe family are made of corrosion-resistant stainless steel and can be directly screwed onto a field device. The permanently connected lines are connected to the terminals of the field device. Surge protective devices for series connection and parallel connection are available. Arresters for series connection are located directly in the cable run which ensures energy coordination with other arresters. These arresters can also be used for field devices with a single field device terminal or a single cable gland. Arresters for parallel connection are attached to the spare cable gland of the field devices or in the field bus distributor and are situated in parallel to the cable run. Due to their design, both versions have an IP 67 degree of protection.

Ex(i) und Ex(d) versions are available for field devices in potentially explosive atmospheres. Depending on the type, the arresters can thus be installed on field devices in intrinsically safe measuring circuits Ex(i) or on devices with flameproof enclosure and are suitable for use in Ex zone 1 or 2.

The surge arresters are ideally suited for installation in process environments, for example on transducers or field bus devices. 4-20 mA measuring circuits or bus systems up to 30 V are typical fields of application.

SPDs for Field Devices



Types for series connection.



Robust type made of corrosion-resistant stainless steel.



Metric and NPT thread.



ATEX and IECEx approval.

DPI MD

Energy-coordinated two-stage arrester, no leakage currents to earth, for 4-20 mA interfaces with M20 x 1.5 thread (female/male). Direct, indirect or no shield earthing. Cable gland available as accessory part.

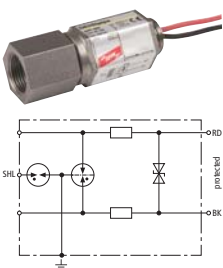

Type DPI ...	MD 24 M 2S
Part No.	929 941
SPD class	TYPE 2 PI
Max. continuous operating voltage (d.c.) (U <sub>c</sub> )	34.8 V
Nominal current (I <sub>n</sub> )	0.5 A
D1 Lightning impulse current (10/350 μs) per line (I <sub>imp</sub> )	1 kA
C2 Total nominal discharge current (8/20 μs) (I <sub>n</sub> )	10 kA
Cut-off frequency line-line (f <sub>G</sub> )	14 MHz
For mounting on (field / device side)	M20 x 1.5 female thread / M20 x 1.5 male thread
Approvals	EAC, SIL

**DPI ME**

Energy-coordinated two-stage arrester for unbalanced interfaces with 1/2-14 NPT thread (male/male). The earthing conductor is led through the surge arrester.

Type DPI ...	ME 24 N A2G
Part No.	929 921
SPD class	TYPE 2 P1
Max. continuous operating voltage (d.c.) (U <sub>c</sub> )	34.8 V
Nominal current (I <sub>n</sub> )	0.5 A
D1 Lightning impulse current (10/350 μs) per line (I <sub>imp</sub> )	1 kA
C2 Total nominal discharge current (8/20 μs) (I <sub>n</sub> )	10 kA
For mounting on (field / device side)	1/2-14 NPT male thread / 1/2-14 NPT male thread
Approvals	UL, EAC, SIL

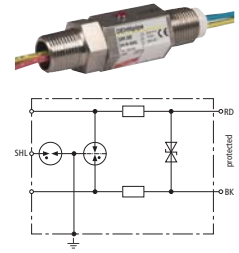

**DPI MD EX**

Energy-coordinated two-stage surge arrester for protecting intrinsically safe measuring circuits and bus systems according to FISCO. Cable glands available as accessory.

Type DPI ...	MD EX 24 M 2
Part No.	929 960
SPD class	TYPE 2 P1
Max. continuous operating voltage (d.c.) (U <sub>c</sub> )	34.8 V
Nominal current (I <sub>n</sub> )	0.5 A
D1 Lightning impulse current (10/350 μs) per line (I <sub>imp</sub> )	1 kA
C2 Total nominal discharge current (8/20 μs) (I <sub>n</sub> )	10 kA
Cut-off frequency line-line (f <sub>c</sub> )	7 MHz
For mounting on (field / device side)	M20 x 1.5 female thread / M20 x 1.5 male thread
Approvals	EAC Ex, ATEX, IECEx, SIL

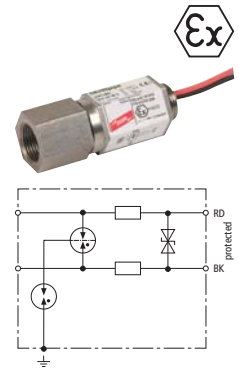

**DPI CD EXI**

Surge arrester for protecting intrinsically safe measuring circuits and bus systems according to FISCO.

Type DPI ...	CD EXI 24 M	CD EXI 24 N
Part No.	929 961	929 963
SPD class	TYPE 2 P1	TYPE 2 P1
Max. continuous operating voltage (d.c.) (U <sub>c</sub> )	32 V	32 V
Nominal current (I <sub>n</sub> )	0.55 A	0.55 A
D1 Lightning impulse current (10/350 μs) line-PG (I <sub>imp</sub> )	1 kA	1 kA
C2 Total nominal discharge current (8/20 μs) (I <sub>n</sub> )	10 kA	10 kA
Cut-off frequency line-line (f <sub>c</sub> )	67 MHz	67 MHz
For mounting on (field / device side)	M20 x 1.5 male thread	1/2-14 NPT male thread
Approvals	EAC Ex, ATEX, IECEx, CSA & USA Hazloc, SIL	EAC Ex, ATEX, IECEx, CSA & USA Hazloc, SIL

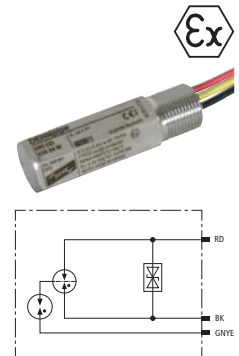

SPDs for Field Devices

**DPI CD EXD**

Surge arrester in a flameproof enclosure for protecting measuring circuits and bus systems in potentially explosive atmospheres.

Type DPI ...	CD EXD 24 M	CD EXD 24 N
Part No.	929 962	929 964
SPD class	TYPE 2 P1	TYPE 2 P1
Max. continuous operating voltage (d.c.) (U <sub>c</sub> )	32 V	32 V
Nominal current (I <sub>n</sub> )	0.55 A	0.55 A
D1 Lightning impulse current (10/350 μs) line-PG (I <sub>imp</sub> )	1 kA	1 kA
C2 Total nominal discharge current (8/20 μs) (I <sub>n</sub> )	10 kA	10 kA
Cut-off frequency line-line (f <sub>c</sub> )	67 MHz	67 MHz
For mounting on (field / device side)	M20 x 1.5 male thread	1/2-14 NPT male thread
Approvals	EAC Ex, ATEX, IECEx, CSA & USA Hazloc, SIL	EAC Ex, ATEX, IECEx, CSA & USA Hazloc, SIL

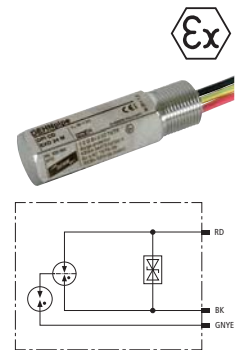

**DPI CD HF EXD**

Surge arrester in a flameproof enclosure for protecting measuring circuits and bus systems with high-frequency signals in potentially explosive atmospheres.

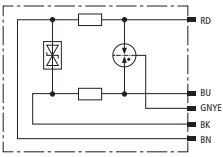

Type DPI ...	<b>CD HF EXD 5 M</b>	
Part No.	<b>929 971</b>	
SPD class	<b>TYPE 2 P1</b>	
Max. continuous operating voltage (d.c.) (U <sub>c</sub> )	6 V	
Nominal current at 80 °C (I <sub>n</sub> )	0.1 A	
C2 Total nominal discharge current (8/20 μs) (I <sub>n</sub> )	20 kA	
Cut-off frequency line-line (f <sub>c</sub> )	100 MHz	
For mounting on (field / device side)	M20 x 1.5 male thread	
Approvals	EAC Ex, ATEX, IECEx, SIL	

**DPI CD EXD 230 24**

Surge arrester in a flameproof enclosure for protecting 120 / 230 V terminal equipment and 0/4-20 mA interfaces in potentially explosive atmospheres.

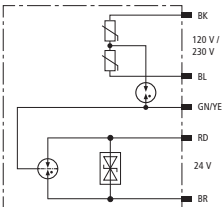

Type DPI ...	CD EXD 230 24 M	CD EXD 230 24 N
Part No.	<b>929 969</b>	<b>929 970</b>
<b>Protection of the data side:</b>		
SPD class	<b>TYPE 2 P2</b>	<b>TYPE 2 P2</b>
Max. continuous operating voltage (d.c.) (U <sub>c</sub> )	32 V	32 V
Nominal current at 80 °C (I <sub>n</sub> )	0.55 A	0.55 A
D1 Lightning impulse current (10/350 μs) line-PG (I <sub>imp</sub> )	1 kA	1 kA
C2 Total nominal discharge current (8/20 μs) (I <sub>n</sub> )	10 kA	10 kA
For mounting on (field / device side)	M20 x 1.5 male thread	1/2-14 npt male thread
Approvals	EAC Ex, ATEX, IECEx, CSA & USA Hazloc, SIL	EAC Ex, ATEX, IECEx, CSA & USA Hazloc, SIL
<b>Protection of the power side:</b>		
SPD according to EN 61643-11 / IEC 61643-11	type 2 / class II	type 2 / class II
Max. continuous operating voltage (a.c.) (U <sub>c</sub> )	255 V	255 V
Total discharge current (8/20 μs) L+N-PE (I <sub>total</sub> )	5 kA	5 kA
Voltage protection level L-N (U <sub>p</sub> )	≤ 1.4 kV	≤ 1.4 kV
Max. mains-side overcurrent protection	16 A gL/gG or B 16 A	16 A gL/gG or B 16 A

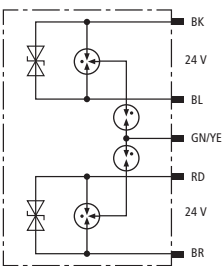

**DPI CD EXI+D 2X24**

Surge arrester in a flameproof enclosure for protecting two 24 V interfaces in potentially explosive atmospheres according to FISCO.

Type DPI ...	CD EXI+D 2X24 M	CD EXI+D 2X24 N
Part No.	<b>929 950</b>	<b>929 951</b>
SPD class	<b>TYPE 2 P1</b>	<b>TYPE 2 P1</b>
Max. continuous operating voltage (d.c.) (U <sub>c</sub> )	36 V	36 V
Nominal current (I <sub>n</sub> )	0.55 A	0.55 A
D1 Lightning impulse current (10/350 μs) line-PG (I <sub>imp</sub> )	1.5 kA	1.5 kA
C2 Total nominal discharge current (8/20 μs) (I <sub>n</sub> )	20 kA	20 kA
For mounting on (field / device side)	M20 x 1.5 male thread	1/2-14 NPT male thread
Approvals	EAC Ex, ATEX, IECEx, CSA & USA Hazloc, SIL	EAC Ex, ATEX, IECEx, CSA & USA Hazloc, SIL

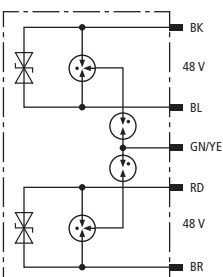

**DPI CD EXI+D 2X48**

Surge arrester in a flameproof enclosure for protecting two 48 V interfaces in potentially explosive atmospheres according to FISCO.

Type DPI ...	CD EXI+D 2X48 M	CD EXI+D 2X48 N
Part No.	<b>929 952</b>	<b>929 953</b>
SPD class	<b>TYPE 2 P1</b>	<b>TYPE 2 P1</b>
Max. continuous operating voltage (d.c.) (U <sub>c</sub> )	58 V	58 V
Nominal current (I <sub>n</sub> )	0.55 A	0.55 A
D1 Lightning impulse current (10/350 μs) line-PG (I <sub>imp</sub> )	1.5 kA	1.5 kA
C2 Total nominal discharge current (8/20 μs) (I <sub>n</sub> )	20 kA	20 kA
For mounting on (field / device side)	M20 x 1.5 male thread	1/2-14 NPT male thread
Approvals	EAC Ex, ATEX, IECEx, CSA & USA Hazloc, SIL	EAC Ex, ATEX, IECEx, CSA & USA Hazloc, SIL

## Accessories for DEHNpipe

**EMC Cable Gland**

Brass gland with shield connection

Type	KV S M20 MS 9.5
Part No.	929 982
Sealing range (Rd)	6.5-9.5 mm
Shield diameter	3.2-6.5 mm
For mounting on	M20 x 1.5
Degree of protection	IP 68

**Cable Gland**

Brass gland without shield connection

Type	KV M20 MS 10.5
Part No.	929 984
Sealing range (Rd)	7.0-10.5 mm
For mounting on	M20 x 1.5
Degree of protection	IP 68





**Brass Earthing Ring**

Earthing ring made of nickel-plated brass, for externally earthing DPI devices.

Type	ER DPI M20
Part No.	929 996
For mounting on	DPI M20 x 1.5



## List of Approvals (as of January 2016)

Part No.	Type	ATEX 	IECEX 	CSA-Hazloc 	SIL (up to SIL3)	UL 	EAC 
929 941	DPI MD 24 M 25				•		•
929 921	DPI ME 24 N A2G				•	•	•
929 960	DPI MD EX 24 M 2	•(1)	•(2)		•		•(13)
929 961	DPI CD EXI 24 M	•(3)	•(4)	•(12)	•		•(13)
929 963	DPI CD EXI 24 N	•(3)	•(4)	•(12)	•		•(13)
929 962	DPI CD EXD 24 M	•(5)	•(6)	•(11)	•		•(14)
929 964	DPI CD EXD 24 N	•(5)	•(6)	•(11)	•		•(14)
929 971	DPI CD HF EXD 5 M	•(5)	•(6)		•		•(14)
929 969	DPI CD EXD 230 24 M	•(7)	•(8)	•(11)	•		•(14)
929 970	DPI CD EXD 230 24 N	•(7)	•(8)	•(11)	•		•(14)
929 950	DPI CD EXI+D 2x24 M	•(9)	•(10)	•(12)	•		•(15)
929 951	DPI CD EXI+D 2x24 N	•(9)	•(10)	•(12)	•		•(15)
929 952	DPI CD EXI+D 2x48 M	•(9)	•(10)	•(12)	•		•(15)
929 953	DPI CD EXI+D 2x48 N	•(9)	•(10)	•(12)	•		•(15)

(1)	DEKRA 11ATEX0076 X: II 2(1) G Ex ia [ia Ga] IIC T4 ... T6 Gb
(2)	DEK 11.0025X: Ex ia [ia Ga] IIC T4 ... T6 Gb
(3)	KEMA 04ATEX1189 X: II 2(1) G Ex ia IIC T5 ... T6 Gb
(4)	KEM 09.0076X: Ex ia [ia Ga] IIC T5 ... T6 Gb
(5)	KEMA 04ATEX2190 X: II 2 G Ex d IIC T5 or T6 Gb
(6)	KEM 09.0064X: Ex d IIC T5 or T6 Gb
(7)	KEMA 10ATEX0114 X: II 2 G Ex d IIC T5 or T6 Gb
(8)	DEK 11.0006X: Ex d IIC T5 or T6 Gb
(9)	DEKRA 11ATEX0207 X: II 2(1) G Ex ia [ia Ga] IIC T5/T6 Gb DEKRA 11ATEX0217 X: II 2 G Ex db IIC T6...T5 Gb
(10)	IECEX DEK 11.0076X: Ex ia [ia Ga] IIC T5/T6 Gb IECEX DEK 11.0079X: Ex db IIC T6 ... T5 Gb

(11)	CSA 10.2317168: Ex d IIC T4 ... T6 CSA 10.2317168: Class I Div 1, 2; Group A,B,C,D T4 ... T6 CSA 10.2317168: Class II Div 1, 2; Group E,F,G CSA 10.2317168: Class III Div 1, 2 CSA 10.2317168: Class I, AEx d IIC T4 ... T6
(12)	CSA 13.70000407: Class I, Zone 1, AEx ia [ia] IIC T5 ... T6 CSA 13.70000407: Class I, Zone 1, AEx nA IIC T5 ... T6 CSA 13.70000407: IS, Class I, Div 1, Group A,B,C,D,E,F,G T5 ... T6 CSA 13.70000407: Class I,II,III; Div 2, Group A,B,C,D,E,F,G T5 ... T6 CSA 13.70000407: Ex ia [ia] IIC T5
(13)	EAC TC RU C-DE.GB06.B00505 0 Ex ia IIC T5/T6
(14)	EAC TC RU C-DE.GB06.B00505 1 Ex d IIC T5/T6 X
15)	EAC TC RU C-DE.GB06.B00505 0 Ex ia IIC T5/T6 X EAC TC RU C-DE.GB06.B00505 1 Ex d IIC T5/T6 X

For more detailed information on approvals and SIL, please visit [www.dehn-international.com](http://www.dehn-international.com).



## DEHNpatch

- Patch cable with built-in surge protection
- Cat. 6 according to ISO/IEC 11801
- CAT 6A in the channel according to ANSI/TIA/EIA-568
- Power over Ethernet (PoE+ according to IEEE 802.3at)
- Easy to retrofit



DEHNpatch is the first Cat. 6A certified patch cable with built-in surge protection that can be used according to IEEE 802.3at up to 57 V.

Designed as a patch cable, DEHNpatch can be easily installed in new installations or retrofitted into existing installations.

DEHNpatch is installed between the patch panel and the active component (a switch for example) instead of the conventional patch cable. The snap-in mechanism of the supporting foot allows the device to be safely earthed via the DIN rail. For single application, DEHNpatch comes with a piece of DIN rail and a fixing device. A mounting set is also available as accessory for multiple application in 19" distribution boards.

Fulfilling the requirements of Category 6, DEHNpatch can be universally used for all data services up to nominal voltages of 57 V. Both existing

applications in offices and industry such as Gigabit Ethernet, ATM or ISDN as well as future services such as Voice over IP and Power over Ethernet can be protected.

Due to its fully shielded design, DEHNpatch can be used in shielded and unshielded networks. Its width is similar to that of an RJ45 socket, allowing up to 24 devices to be installed next to one another in one series and to be integrated into a 19" rack.

DEHNpatch is available with a total patch cable length of 3 m and 5 m (other lengths can be provided available on request).



With RJ45 sockets, fully shielded.



For DIN rail and wall mounting.



Patch cable version, fully shielded.



Mounting set (DIN rail, distance bolts) for 19" mounting sections available as accessory.

**DPA M CAT6**

Universal arrester for Industrial Ethernet, Power over Ethernet (PoE+ according to IEEE 802.3at up to 57 V) and similar applications in structured cabling systems according to Cat. 6 and class E<sub>A</sub> up to 500 MHz. Fully shielded type for DIN rail mounting, cable length of 3 m\*).



Type DPA M ...	<b>CAT6 RJ45S 48</b>
Part No.	<b>929 100</b>
SPD class	<b>TYPE 2 P1</b>
Max. continuous operating voltage (d.c.) (U <sub>c</sub> )	48 V
Max. continuous operating voltage (d.c.) pair-pair (PoE) (U <sub>c</sub> )	57 V
Nominal current (I <sub>n</sub> )	1 A
D1 Lightning impulse current (10/350 μs) per line (I <sub>imp</sub> )	1 kA
C2 Total nominal discharge current (8/20 μs) line-PG (I <sub>n</sub> )	10 kA
Cut-off frequency (f <sub>G</sub> )	250 MHz
Connection (input / output)	RJ45 connecting line / RJ45 connecting line
Approvals	GHMT, EAC

\* Special lengths on request

**DEHNpatch Class E**

Universal arrester ideally suited for Industrial Ethernet, Power over Ethernet (PoE+ acc. to IEEE 802.3at up to 57 V) and similar applications in structured cabling systems according to class E up to 250 MHz. Fully shielded adapter with sockets for DIN rail mounting.



Type DPA M ...	<b>CLE RJ45B 48</b>
Part No.	<b>929 121</b>
SPD class	<b>TYPE 2 P1</b>
Max. continuous operating voltage (d.c.) (U <sub>c</sub> )	48 V
Max. continuous operating voltage (d.c.) pair-pair (PoE) (U <sub>c</sub> )	57 V
Nominal current (I <sub>n</sub> )	1 A
D1 Lightning impulse current (10/350 μs) per line (I <sub>imp</sub> )	0.5 kA
C2 Total nominal discharge current (8/20 μs) line-PG (I <sub>n</sub> )	10 kA
Cut-off frequency (f <sub>G</sub> )	250 MHz
Connection (input / output)	RJ45 socket / RJ45 socket
Approvals	CSA, UL, EAC

**DEHNpatch Class D**

Universal arrester according to class D up to 100 MHz. DIN rail mounted shielded adapter type with sockets.



Type DPA M ...	<b>CLD RJ45B 48</b>
Part No.	<b>929 126</b> <small>NEW</small>
SPD class	<b>TYPE 2 P2</b>
Max. continuous operating voltage (d.c.) (U <sub>c</sub> )	48 V
Max. continuous operating voltage (d.c.) pair-pair (PoE) (U <sub>c</sub> )	57 V
Nominal current (I <sub>n</sub> )	1 A
D1 Lightning impulse current (10/350 μs) per line (I <sub>imp</sub> )	0.5 kA
C2 Total nominal discharge current (8/20 μs) line-PG (I <sub>n</sub> )	10 kA
Cut-off frequency (f <sub>G</sub> )	100 MHz
Connection (input / output)	RJ45 socket / RJ45 socket
Approvals	UL

SPDs for Tel. and Data Networks

**Accessories for DEHNpatch**

**Mounting Set for DEHNpatch**

The set comprises a DIN rail for up to 24 DEHNpatch devices and different distance bolts with sliding nuts for installation into data distributors. To save space, the DIN rail can be mounted at the distributor panel or even upstream of the mounting sections in a 19" grid dimension.



Type	<b>MS DPA</b>
Part No.	<b>929 199</b>
Mounting in	19" cabinets

**482.6 mm (19 inch) Universal DIN Rail Carrier**

For 19" technology (3 rack units) or wall mounting. DIN rail can be mounted vertically or horizontally.



Type	<b>MF DR 3RU 19"</b>
Part No.	<b>929 335</b> <small>NEW</small>
Dimensions	3 vertical modules
Enclosure material	aluminium/zinc sheet / <b>StSt</b>





**NET Protector**

- Protects switches, hubs and telecommunications systems against overvoltage
- Allows class D networks to be established according to EN 50173 (Gigabit Ethernet)
- Patch panels can be flexibly equipped
- Retrofit versions with plug-in inputs and outputs

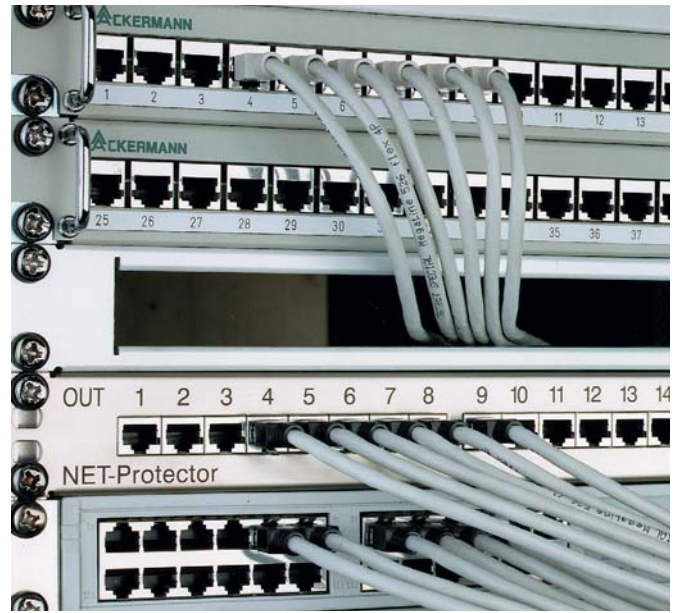

The 482.6 mm (19 inch) enclosure can be equipped with surge protection components for protecting network components (class D) or telecommunications systems.

The 482.6 mm (19 inch) enclosure can be equipped with up to three surge protection components to protect active network components such as hubs, switches (class D) or telecommunication systems. NET Protector is typically used for Ethernet, Token Ring, E1 and telephone systems.

It only requires the space of one rack unit and is generally installed in terminal boards. It is inserted as a patch panel with surge protection or as a retrofit version for patching between the patch panel and the device to be protected.

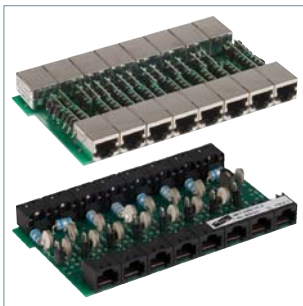

Surge protection components for protecting 8 channels.

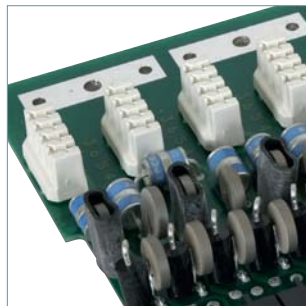

Version with LSA connection for use as patch field version in new installations.

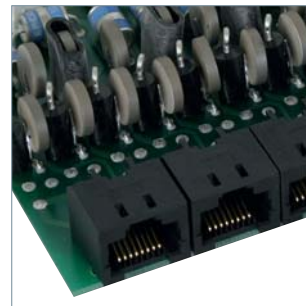

Retrofit version with RJ45 connection for existing installations.



Version with RJ45 sockets shielded on both ends.

SPDs for Tel. and Data Networks

**NET PRO 4TP**

Surge protection component with eight shielded ports for universal cabling systems (class D). Retrofit or patch panel version (LSA).

Type NET PRO ...	4TP	LSA 4TP	4TP 30
Part No.	929 035	929 036	929 037
SPD class	TYPE 3 P1	TYPE 3 P1	TYPE 4 P1
Max. continuous operating voltage (d.c.) (U <sub>c</sub> )	6 V	6 V	30 V
Nominal current (I <sub>n</sub> )	100 mA	100 mA	100 mA
C2 Nominal discharge current (8/20 μs) per port (I <sub>n</sub> )	2.4 kA	2.4 kA	0.8 kA
Cut-off frequency line-line at 100 ohms (f <sub>c</sub> )	165 MHz	170 MHz	300 MHz
Approvals	GHMT, EAC	EAC	EAC

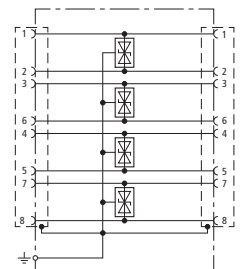

**NET PRO TC**

Surge protection component with eight ports for telecommunications systems. Retrofit or patch panel version (LSA).

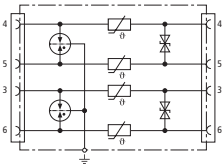

Type NET PRO ...	TC 2	TC 2 LSA
Part No.	929 071	929 072
SPD class	TYPE 2 P2	TYPE 2 P2
Max. continuous operating voltage (d.c.) (U <sub>c</sub> )	170 V	170 V
Nominal current (I <sub>n</sub> )	150 mA	150 mA
D1 Lightning impulse current (10/350 µs) per line (I <sub>imp</sub> )	1 kA	1 kA
C2 Nominal discharge current (8/20 µs) per port (I <sub>n</sub> )	10 kA	20 kA
Series resistance per line	10 ohms	10 ohms
Cut-off frequency line-line (f <sub>G</sub> )	10 MHz	10 MHz
Approvals	EAC	EAC

**NET PRO E1 LSA**

Surge protection component with eight ports for E1 interfaces as patch panel version.

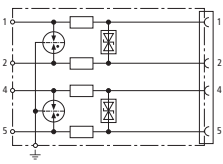

Type NET PRO ...	E1 LSA G703
Part No.	929 075
SPD class	TYPE 2 P1
Max. continuous operating voltage (d.c.) (U <sub>c</sub> )	6 V
Nominal current (I <sub>n</sub> )	200 mA
D1 Lightning impulse current (10/350 µs) per line (I <sub>imp</sub> )	1 kA
C2 Nominal discharge current (8/20 µs) per port (I <sub>n</sub> )	20 kA
Series resistance per line	1 ohm
Cut-off frequency line-line at 100 ohms (f <sub>G</sub> )	210 MHz
Approvals	EAC

**NET PRO 10X TC1 RST**

Surge protection component with ten ports for protecting telecommunications systems with analogue or system transmission technology from overvoltage and a.c. interference. Cage spring terminals which can be removed from the protection component as a block are situated on the input side, thus allowing to test the lines. For installation into EG NET PRO 10X 19" or EG NET PRO 10X 3HE enclosures.

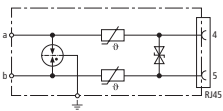

Type NET PRO ...	10X TC1 RST
Part No.	929 230
SPD class	TYPE 2 P2
Max. continuous operating voltage (d.c.) (U <sub>c</sub> )	180 V
Nominal current at 20 °C / 50 °C / 70 °C (I <sub>n</sub> )	120 mA / 100 mA / 60 mA
D1 Lightning impulse current (10/350 µs) per line (I <sub>imp</sub> )	1 kA
C2 Nominal discharge current (8/20 µs) per port (I <sub>n</sub> )	10 kA
Series resistance per line	3-12 ohms
Cut-off frequency at 100 ohms (f <sub>G</sub> )	55 MHz
Approvals	EAC

SPDs for Tel. and Data Networks

**Accessories for NET Protector**

**482.6 mm (19 inch) Enclosure**

Fully shielded empty enclosure for max. three NET Protector protection components.



Type	EG NET PRO 19"
Part No.	929 034
Dimensions	1 rack unit
Enclosure material	stainless steel front / galvanised sheet metal

**482.6 mm (19 inch) Enclosure, unshielded**





Unshielded 19 inch enclosure (one rack unit) for max. five NET PRO 10X modules, with two earth terminals and cable rail.

Accessories: two nuts, two flat washers and two toothed lock washers for installing the earth terminal.



Type	EG NET PRO 10X 19"
Part No.	929 234
Dimensions	1 rack unit
Enclosure material	StSt (V2A)

## SPDs for Building Systems

Product	Description	Type	Part No.	Page
<b>DEHNprotector</b>				
	<ul style="list-style-type: none"> <li>– Combined adapter for protecting the power and data side of a terminal device</li> <li>– Different versions for protecting different interfaces</li> <li>– With visual operating state / fault indication</li> </ul>	<b>DPRO 230 TV</b>	<b>909 300</b>	<b>194</b>
		<b>DPRO 230 NT</b>	<b>909 310</b>	<b>195</b>
		<b>DPRO 230 ISDN</b>	<b>909 320</b>	<b>195</b>
		<b>DPRO 230 LAN100</b>	<b>909 321</b>	<b>195</b>
<b>BUStector</b>				
	<ul style="list-style-type: none"> <li>– Surge arrester for protecting KNX / EIB systems</li> <li>– Optimally adapted to KNX / EIB systems</li> <li>– EIBA-approved</li> </ul>	<b>BT 24</b>	<b>925 001</b>	<b>196</b>
<b>DEHNbox</b>				
	<ul style="list-style-type: none"> <li>– Wall-mounted universal lightning current and surge arrester</li> <li>– Integrated actiVsense technology</li> <li>– Easy installation and retrofitting</li> </ul>	<b>DBX TC 180</b>	<b>922 210</b>	<b>198</b>
		<b>DBX U4 KT BD 0-180</b>	<b>922 400</b>	<b>198</b>
		<b>DBX U2 KT BD 0-180</b>	<b>922 200</b>	<b>198</b>
<b>DEHNlink</b>				
	<ul style="list-style-type: none"> <li>– Wall-mounted surge arrester for protecting telecommunication interfaces</li> <li>– Versions with operating state indication of the remote supply voltage</li> <li>– Easy installation and retrofitting</li> </ul>	<b>DLI ISDN I</b>	<b>929 024</b>	<b>199</b>
		<b>DLI TC 2 I</b>	<b>929 028</b>	<b>200</b>
		<b>DLI TC ECO RJ12</b>	<b>929 081</b>	<b>200</b>
		<b>DLI TC BT</b>	<b>929 026</b>	<b>200</b>



**DEHNprotector**



- Combined surge protection for the power and data side of terminal equipment
- Protection of
  - TVs and satellite devices
  - ISDN and telephone systems
  - Ethernet components
- Visual operating state / fault indication
- Easy retrofitting

The arresters of the DEHNprotector family are plugged into earthed socket outlets and protect terminal equipment with an additional data interface. Overvoltages are discharged to the PE contact of the socket outlet. The plug-in installation facilitates retrofitting of surge protection. The surge protective device for the power side features a visual operating state and fault indication, thus ensuring easy maintenance.

Combined surge protective adapter with visual operating state and fault indication plugged into an earthed socket outlet.



Type with coaxial connection.



Type with RJ connection.



Plug for earthed socket outlets for protecting the power side.



Visual operating state and fault indication of the power side.

For further surge protective adapters for protecting the power supply of electronic devices please also refer to pages 103.

**DPRO 230 TV**

Combined surge protection for the power and antenna side of TV, radio or satellite receivers. With visual operating state and fault indication and integrated child lock.



Type DPRO 230 ...	TV
Part No.	909 300
<b>Protection of the data side:</b>	
SPD class	TYPE 2
Max. continuous operating voltage (d.c.) (U <sub>c</sub> )	60 V
C2 Nominal discharge current (8/20 μs) line-shield (PE) (I <sub>n</sub> )	5 kA
Insertion loss 0-2400 MHz	≤ 1.5 dB
Connection (input / output)	F socket / F socket
Approvals	EAC
<b>Protection of the power side:</b>	
SPD according to EN 61643-11 / IEC 61643-11	type 3 / class III
Max. continuous operating voltage (a.c.) (U <sub>c</sub> )	255 V (50 / 60 Hz)
Total discharge current (8/20 μs) [L+N-PE] (I <sub>total</sub> )	5 kA
Voltage protection level [L-N] (U <sub>p</sub> )	≤ 1.25 kV
Max. mains-side overcurrent protection	16 A gL/gG or B 16 A

**DPRO 230 NT**

Combined surge protection for the power and data side of a digital network termination (NT). Also suited for telephones and fax machines. With visual operating state and fault indication and integrated child lock.

Type DPRO 230 ...	NT
Part No.	909 310
<b>Protection of the data side:</b>	
SPD class	TYPE 2+P1
Max. continuous operating voltage (d.c.) (U <sub>c</sub> )	180 V
Lightning impulse current (10/350 µs) per line D1 (I <sub>imp</sub> )	1 kA
C2 Nominal discharge current (8/20 µs) per line (I <sub>n</sub> )	2.5 kA
Cut-off frequency (f <sub>G</sub> )	50 MHz
Connection (input / output)	RJ12 socket / RJ12 socket
Approvals	EAC
<b>Protection of the power side:</b>	
SPD according to EN 61643-11 / IEC 61643-11	type 3 / class III
Max. continuous operating voltage (a.c.) (U <sub>c</sub> )	255 V (50 / 60 Hz)
Total discharge current (8/20 µs) [L+N-PE] (I <sub>total</sub> )	5 kA
Voltage protection level [L-N] (U <sub>p</sub> )	≤ 1.25 kV
Max. mains-side overcurrent protection	B 16 A



**DPRO 230 ISDN**

Combined surge protection for the power and ISDN S<sub>0</sub> side of ISDN systems and devices. Shielded port allows to protect Ethernet 10 BT. With visual operating state and fault indication and integrated child lock.

Type DPRO 230 ...	ISDN
Part No.	909 320
<b>Protection of the data side:</b>	
SPD class	TYPE 2+P1
Max. continuous operating voltage (d.c.) (U <sub>c</sub> )	48 V
Lightning impulse current (10/350 µs) per line D1 (I <sub>imp</sub> )	1 kA
C2 Total nominal discharge current (8/20 µs) (I <sub>n</sub> )	10 kA
Cut-off frequency (f <sub>G</sub> )	50 MHz
Connection (input / output)	shielded RJ45 socket / shielded RJ45 socket
Approvals	EAC
<b>Protection of the power side:</b>	
SPD according to EN 61643-11 / IEC 61643-11	type 3 / class III
Max. continuous operating voltage (a.c.) (U <sub>c</sub> )	255 V (50 / 60 Hz)
Total discharge current (8/20 µs) [L+N-PE] (I <sub>total</sub> )	5 kA
Voltage protection level [L-N] (U <sub>p</sub> )	≤ 1.25 kV
Max. mains-side overcurrent protection	B 16 A



**DPRO 230 LAN100**

Combined surge protection for the power side and data input for protecting LAN components. Protection of all pairs for Ethernet pin assignment. It meets the requirements for channel class D in accordance with EN 50173 and is thus suitable for 1000 Base-T (Gigabit Ethernet). With visual operating state and fault indication and integrated child lock.

Type DPRO 230 ...	LAN100
Part No.	909 321
<b>Protection of the data side:</b>	
SPD class	TYPE 2+P1
Max. continuous operating voltage (d.c.) (U <sub>c</sub> )	58 V
Lightning impulse current (10/350 µs) per line D1 (I <sub>imp</sub> )	1 kA
C2 Total nominal discharge current (8/20 µs) (I <sub>n</sub> )	10 kA
Cut-off frequency (f <sub>G</sub> )	120 MHz
Connection (input / output)	shielded RJ45 socket / shielded RJ45 socket
Approvals	EAC
<b>Protection of the power side:</b>	
SPD according to EN 61643-11 / IEC 61643-11	type 3 / class III
Max. continuous operating voltage (a.c.) (U <sub>c</sub> )	255 V (50 / 60 Hz)
Total discharge current (8/20 µs) [L+N-PE] (I <sub>total</sub> )	5 kA
Voltage protection level [L-N] (U <sub>p</sub> )	≤ 1.25 kV
Max. mains-side overcurrent protection	B 16 A





**BUSector**



Surge arrester for KNX / EIB buses with connection wires

- Surge arrester for KNX / EIB buses 
- Extremely space-saving due to KNX / EIB bus terminal design
- System-tested with EIBA certification

The discharge capacity, protective effect and mechanical design of BUSector surge arresters are adapted to the installation environment of KNX / EIB buses. Like a bus terminal, they can be plugged onto the bus terminal pins of a terminal device and can be connected by means of the existing connecting cables. BUSector surge arresters can also be connected to an existing bus terminal on the terminal device. They particularly protect line and area couplers as well as gateways and sensors installed at the outer walls of buildings.

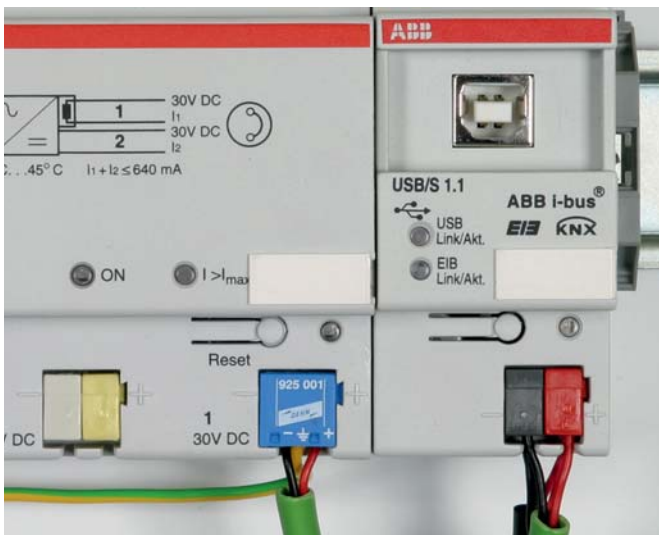

Protection of a KNX power supply unit by means of a BUSector surge arrester mounted in the bus terminal slot



Protection of a KNX bus coupling unit by means of a BUSector surge arrester mounted on a bus terminal in the mounting panel of a cable duct

**BT**

Surge arrester with bus terminal design, adapted to the immunity of KNX / EIB systems. EIBA-certified.



Type	BT 24
Part No.	925 001
SPD class	<b>TYPE 2</b>
Max. continuous operating voltage (d.c.) (U <sub>c</sub> )	45 V
Nominal current (I <sub>n</sub> )	6 A
D1 Lightning impulse current (10/350 μs) per line	1 kA
C2 Nominal discharge current per line (I <sub>n</sub> )	5 kA
Cut-off frequency line-line (f <sub>c</sub> )	70 MHz
Approvals	EIBA certification No. Z 32/1399/95, EAC



## DEHNbox

- Combined lightning current and surge arrester
  - Capable of carrying lightning currents up to 10 kA (10/350  $\mu$ s)
  - Low voltage protection level, capable of protecting terminal equipment
  - For installation in conformity with the lightning protection zone concept at the boundaries from  $0_A - 2$  and higher
- Easy to use
  - Suitable for wall mounting, IP 65 degree of protection
  - Fast and easy installation due to spring-loaded terminals
  - Easy retrofitting of surge protection



DEHNbox used for a telecommunication connection (example:  $U_{k0}$  interface)

The compact arresters of the DEHNbox product family are combined lightning current and surge arresters designed for protecting information, measuring and control and automation equipment and systems. With its surface-mounted plastic enclosure with integrated fixing lugs, DEHNbox is ideally suited for wall mounting and can be easily retrofitted into existing equipment and systems. The IP 65 degree of protection allows the arrester to be used in harsh environments such as in moist atmospheres. The conductors are therefore entered via easy-to-install self-sealing rubber grommets. These grommets allow easy and fast installation and prevent the ingress of moisture and dust. Both the cores and an installed line shield can be contacted by means of spring-loaded terminals without the use of screws. DEHNbox is available in two versions:

### DEHNbox TC 180

The arrester is optimised for use at telecommunication connections and devices such as analogue telephones as well as ISDN and VDSL2 connections. With a cut-off frequency up to 250 MHz, the arrester is also capable of transmitting high-frequency signal parts and can thus be used at high-performance signal interfaces. As an alternative, DEHNbox TC 180 can also be installed at measuring and control interfaces up to a voltage of 180 V and a maximum current of 750 mA. DEHNbox TC 180 allows fast connection of one pair without tools and fixing of the connecting cable (integrated strain relief) on the printed

circuit board by means of cable ties. The connection space in the box and the position of the terminals ensure optimal conductor routing and easy conductor connection.

### DEHNbox with actiVsense technology

This arrester type does not have a specific nominal voltage and can thus be used for voltages ranging from 0 to 180 V with a superimposed signal voltage ( $\pm 5$  V/50 MHz). The nominal current is limited to 100 mA which is sufficient for information technology systems. This innovative actiVsense technology allows the arrester to detect the signal voltage applied and to automatically adapt the voltage protection level to this voltage. This makes the arrester ideal for applications where changing or slowly fluctuating signal levels ( $\leq 400$  Hz) are to be expected. In case of interference, DEHNbox arresters have an adapted voltage protection level for every signal voltage, thus providing maximum protection for the devices and system circuits connected to them. The four-pole version of DEHNbox provides protection for two different balanced interfaces, e.g. a bus interface with a system voltage of 5 V and an analogue measured value signal with a system voltage of 24 V.

The arrester is ideally suited for domestic and industrial use in information technology transmission systems such as telecommunication, bus and measuring and control systems.



Cable entry with self-sealing rubber grommets.

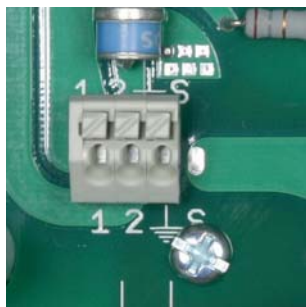

Conductor terminals for fast connection without tools (DBX TC 180).



Conductor fixing by means of cable ties (DBX TC 180).

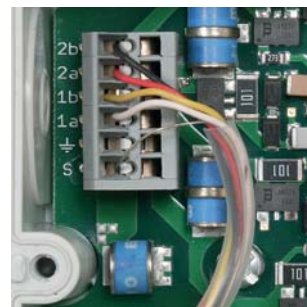

Available with direct or indirect shield earthing (DBX U4/U2 KT BD S 0-180).

**NEW**

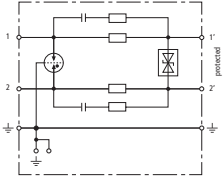

**DBX TC 180**

Compact combined arrester in a surface-mounted plastic enclosure for protecting information technology interfaces, particularly telecommunication connections and devices such as analogue telephone, ISDN and xDSL (VDSL2-tested). Fast connection of one pair without tools and integrated strain relief for the connecting cable. Cut-off frequency up to 250 MHz ensures maximum transmission performance in case of high-frequency signal parts.

Type DBX ...	TC 180
Part No.	922 210 <b>NEW</b>
SPD class	TYPE 1P2
Max. continuous operating voltage (d.c.) ( $U_c$ )	180 V
Nominal current at 45°C ( $I_n$ )	0.75 A
D1 Total lightning impulse current (10/350 $\mu$ s) ( $I_{imp}$ )	7.5 kA
C2 Total nominal discharge current (8/20 $\mu$ s) ( $I_n$ )	15 kA
Series resistance per line	1.8 ohms
Bandwidth line-line (100 ohms) ( $f_G$ )	250 MHz
Dimensions (L x W x H)	93 x 93 x 55 mm

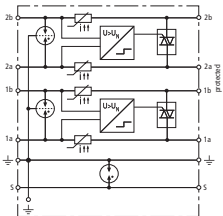

**DBX U4 KT BD S 0-180**

Compact combined lightning current and surge arrester in a surface-mounted plastic enclosure with actiVsense technology for protecting two pairs with the same or a different signal voltage of galvanically isolated balanced interfaces. The actiVsense technology automatically detects the operating voltage and optimally adapts the voltage protection level to it.

Type DBX ...	U4 KT BD S 0-180
Part No.	922 400
SPD class	TYPE 1P1
Max. continuous operating voltage (d.c.) ( $U_c$ )	180 V
Permissible superimposed signal voltage ( $U_{signal}$ )	$\leq \pm 5$ V
Cut-off frequency line-line ( $U_{signal}$ , balanced 100 ohms) ( $f_G$ )	50 MHz
Nominal current $I_n$ (equals max. short-circuit current)	100 mA
D1 Total lightning impulse current (10/350 $\mu$ s) ( $I_{imp}$ )	10 kA
C2 Total nominal discharge current (8/20 $\mu$ s) ( $I_n$ )	20 kA
Series resistance per line	$\leq 9$ ohms; typically 7.9 ohms
Dimensions (L x W x H)	93 x 93 x 55 mm

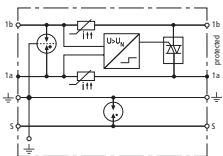

**DBX U2 KT BD S 0-180**

Compact combined lightning current and surge arrester in a surface-mounted plastic enclosure with actiVsense technology for protecting one pair of galvanically isolated balanced interfaces. The actiVsense technology automatically detects the operating voltage and optimally adapts the voltage protection level to it.

Type DBX ...	U2 KT BD S 0-180
Part No.	922 200
SPD class	TYPE 1P1
Max. continuous operating voltage (d.c.) ( $U_c$ )	180 V
Permissible superimposed signal voltage ( $U_{signal}$ )	$\leq \pm 5$ V
Cut-off frequency line-line ( $U_{signal}$ , balanced 100 ohms) ( $f_G$ )	50 MHz
Nominal current $I_n$ (equals max. short-circuit current)	100 mA
D1 Total lightning impulse current (10/350 $\mu$ s) ( $I_{imp}$ )	9 kA
C2 Total nominal discharge current (8/20 $\mu$ s) ( $I_n$ )	20 kA
Series resistance per line	$\leq 9$ ohms; typically 7.9 ohms
Dimensions (L x W x H)	93 x 93 x 55 mm

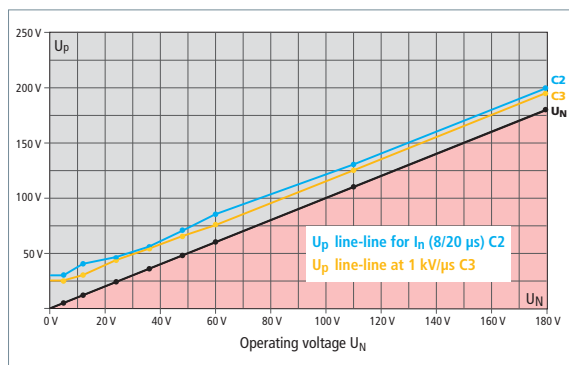

Voltage protection level diagram (DBX U4/U2 KT BD S 0-180)

SPDs for Building Systems





**DEHNlink**

- Surface-mounted surge protective device for telecommunications systems
- Quick installation due to plug-in terminals
- Different interface-specific types

The surface-mounted surge arresters with a modern design particularly protect modems and telephone systems with RJ plugs. The plug-in terminals allow easy installation.



Surface-mounted surge arrester for telecommunications terminal equipment as well as telephone systems with RJ plug.



Easy and fast installation by means of RJ plug-in system.



DLI ISDN I and DLI TC 2 I devices feature an LED display that indicates the supply voltage.



DLI ISDN I is capable of protecting two terminal devices at the same time.



Fixing lugs on the enclosure allow easy and fast wall mounting.

**DLI ISDN I**

Energy-coordinated surge arrester with two protected ISDN  $S_0$  outputs and operating state indication (LED). Connecting cable and mounting material included.

Type DLI ...	<b>ISDN I</b>
Part No.	<b>929 024</b>
SPD class	<b>TYPE 2 P1</b>
Max. continuous operating voltage (d.c.) ( $U_c$ )	7.5 V
Max. continuous operating voltage (d.c.) pair-pair ( $U_c$ )	45 V
Nominal current ( $I_n$ )	200 mA
D1 Lightning impulse current (10/350 $\mu$ s) per line ( $I_{imp}$ )	1 kA
C2 Total nominal discharge current (8/20 $\mu$ s) ( $I_n$ )	10 kA
Cut-off frequency line-line ( $f_c$ )	2 MHz
Connection (input / output)	RJ45 / 2 x RJ45
Approvals	EAC

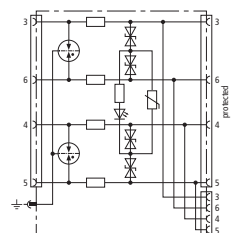



**DLI TC I**

Two-stage surge arrester with overcurrent protection for analogue or system telephones with operating state indication (LED). Even protects from alternating current interference. Pins compatible with RJ11/12 plugs. Connecting cable and mounting material included.

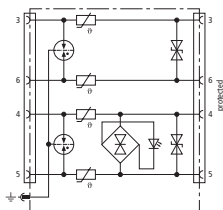

Type DLI ...	TC 2 I
Part No.	929 028
SPD class	TYPE 2 P2
Max. continuous operating voltage (d.c.) (U <sub>c</sub> )	170 V
Nominal current (I <sub>n</sub> )	150 mA
D1 Lightning impulse current (10/350 μs) per line (I <sub>imp</sub> )	1 kA
C2 Total nominal discharge current (8/20 μs) (I <sub>n</sub> )	10 kA
Cut-off frequency line-line (f <sub>G</sub> )	10 MHz
Connection (input / output)	RJ45 / RJ 45 (compatible with RJ12)
Approvals	EAC



**DLI TC**

High-capacity surge arrester for analogue or system telephones, RJ12 sockets.

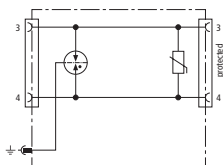

Type DLI ...	TC ECO RJ12
Part No.	929 081
SPD class	TYPE 2 P2
Max. continuous operating voltage (d.c.) (U <sub>c</sub> )	170 V
Nominal current (I <sub>n</sub> )	200 mA
D1 Lightning impulse current (10/350 μs) per line (I <sub>imp</sub> )	1 kA
C2 Total nominal discharge current (8/20 μs) (I <sub>n</sub> )	5 kA
Cut-off frequency line-line (f <sub>G</sub> )	10 MHz
Connection (input / output)	RJ12 / RJ12
Approvals	EAC

**DEHNlink TC BT**



- Surface-mounted surge protective device for telecommunications systems
- Plug-in terminals allow quick installation
- Im compliance with British Telecom requirements

The surface-mounted surge arrester is perfectly suited for telecommunications terminal equipment and telephone systems with BT plug. The device meets the requirements of OfTel NS/G/23/L/100005 for connections between the network termination of a public telephone installation and any telecommunications terminal equipment. Fulfils BS6651:1992, Appendix C, Category C-High and CCITT K17.

Surface-mounted surge arrester for telecommunications terminal equipment and telephone systems with BT plug.



**DLI TC BT**

Surge protective device for analogue or system telephones in accordance with British Telecom requirement

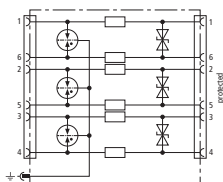

Type	DLI TC BT
Part No.	929 026
SPD class	TYPE 2 P2
Max. continuous operating voltage (d.c.) (U <sub>c</sub> )	145 V
Nominal current (I <sub>n</sub> )	125 mA
D1 Lightning impulse current (10/350 μs) per line (I <sub>imp</sub> )	1 kA
C2 Total nominal discharge current (8/20 μs) (I <sub>n</sub> )	10 kA
Cut-off frequency (f <sub>G</sub> )	13 MHz
Connection (input / output)	BT jack / BT jack
Test standards	IEC 61643-21

## SPDs for Coaxial Connection

Product	Description	Type	Part No.	Page
<b>UGKF BNC</b>				
	<ul style="list-style-type: none"> <li>– Easily adaptable</li> <li>– With indirect shield earthing to avoid leakage pickups</li> <li>– Protection of video cameras</li> </ul>	UGKF BNC	929 010	202
<b>DEHNgate BNC VC</b>				
	<ul style="list-style-type: none"> <li>– Easily adaptable</li> <li>– For DIN rail or wall mounting</li> <li>– With direct or indirect shield earthing</li> </ul>	DGA BNC VCD DGA BNC VCID	909 710 909 711	204 204
<b>DEHNgate FF / GF / GFF TV</b>				
	<ul style="list-style-type: none"> <li>– Combinable system of lightning current and surge arresters</li> <li>– With F connection for 75 ohm satellite and broadband cable systems</li> <li>– Integrated measuring output</li> </ul>	DGA FF TV DGA GF TV DGA GFF TV	909 703 909 704 909 705	204 204 204
<b>DEHNgate F</b>				
	<ul style="list-style-type: none"> <li>– Easy retrofitting</li> <li>– For high transmission rates</li> <li>– With 1.6 / 5.6 connection</li> </ul>	DGA F 1.6 5.6	929 040	204
<b>DEHNgate G</b>				
	<ul style="list-style-type: none"> <li>– Compact dimensions</li> <li>– Wide transmission range</li> <li>– With SMA, BNC or N connection</li> </ul>	DGA G SMA DGA G BNC DGA G N	929 039 929 042 929 044	204 204 204
<b>DEHNgate AG</b>				
	<ul style="list-style-type: none"> <li>– Exchangeable gas discharge tube</li> <li>– Long endurance</li> </ul>	DGA AG BNC DGA AG N	929 043 929 045	205 205
<b>DEHNgate LG / L4</b>				
	<ul style="list-style-type: none"> <li>– Wide transmission range for multi-frequency applications</li> <li>– Integrated quarterwave technology</li> <li>– With 7/16 or N connection</li> </ul>	DGA LG 7 16 MFA DGA L4 7 16 S DGA L4 7 16 MFA DGA L4 N EB	929 146 929 047 929 148 929 059	205 205 205 205



UGKF



Surge arrester designed as cable adapter for protecting coaxial systems such as video and camera systems from potential damage.

UGKF BNC shielded surge arresters are plugged into coaxial terminal equipment or connections. Common applications include the protection of outdoor video surveillance systems or video control centres. In order to avoid being effected by leakage pickups, the cable shield is earthed indirectly via a gas discharge tube. The arrester entries are used as sockets and the protected outputs as plugs.

Devices for video systems with a higher supply voltage or sockets on both ends are available on request.

- Plug-in surge protective adapter for easy retrofitting
- Directly plugs into coaxial terminal equipment
- Integrated indirect shield earthing avoids leakage pickups

We recommend to use DGA BNC VC... arresters for easy installation on a DIN rail. These space-saving surge arresters have BNC sockets and protect video and camera systems.

Two versions are available: DGA BNC VCD with direct connection of the cable shield to the earth potential or DGA BNC VCID with indirect connection of the cable shield. The arresters are earthed via the DIN rail.



UGKF BNC can be directly plugged into the interfaces of terminal equipment.



Different versions of UGKF BNC.



DGA BNC VC ... can be easily adapted due to BNC connection.



DGA BNC VC... can be easily mounted on DIN rails or walls.

UGKF BNC

Two-stage surge arrester with indirect shield earthing for video cameras and Arcnet with BNC connection to avoid leakage pickups.



Type	UGKF BNC
Part No.	929 010
SPD class	TYPE 2Pi
Max. continuous operating voltage (d.c.) (U <sub>c</sub> )	8 V
Nominal current (I <sub>L</sub> )	0.1 A
C2 Nominal discharge current (8/20 μs) per line (I <sub>n</sub> )	2.5 kA
Insertion loss at 300 MHz (50 ohms)	≤ 3 dB
Return loss at 40 MHz (50 ohms)	≥ 20 dB
Insertion loss at 265 MHz (75 ohms)	≤ 3 dB
Return loss at 40 MHz (75 ohms)	≥ 20 dB
Approvals	CSA, UL, EAC



## DEHNgate

- Universal surge and combined arresters
- Maximum discharge capacity for coaxial systems
- Low voltage protection level allows to protect terminal equipment
- Contact materials with extremely long endurance



DEHNgate is a family of lightning current / surge arresters with a cable adapter design for protecting coaxial systems such as cell sites and antenna systems from potential damage. Different mechanical and electrical types are available according to the application. The different designs and arrester technologies allow optimally adapted solutions for a wide range of applications.

DG A FF TV can be mounted on DIN rails in a space-saving way to protect satellite systems with several outputs. For single applications such as broadband cable connections, the device can be simply snapped into a wall-mounted adapter. Two F connections are also included.

The quarterwave surge arresters are bandpass filter. Only signals within a defined frequency band are transmitted. Since lightning interferences have a low frequency spectrum, the shorting stub acts as a short-circuit, conducting the lightning current to the ground. This makes the surge arresters mechanically very robust and almost maintenance-free. Due to their low voltage protection level and high discharge capacity, they can be used as combined lightning current and surge arresters. If additional remote supply is needed for the antenna, a combination of a gas discharge tube and quarterwave technology (DGA LG) should be used. The arresters are made of top-quality materials and provide excellent endurance.



Surge arrester for satellite and broadband cable systems.



F connection for 75 ohm systems.



Types with exchangeable gas capsule.



Maintenance-free quarterwave surge arresters for protecting high-frequency applications (e.g. LTE).

**DGA BNC VC**

The space-saving surge arrester with BNC socket can be mounted on DIN rails for protecting video and camera systems. Available with direct (VCD) or indirect shield connection (VCID) depending on the type to avoid being effected by leakage pickups.



Type DGA ...	BNC VCD	BNC VCID
Part No.	909 710	909 711
SPD class	TYPE 2 P1	TYPE 2 P1
Max. continuous operating voltage (d.c.) (U <sub>c</sub> )	6.4 V	6.4 V
Nominal current (I <sub>t</sub> )	0.1 A	0.1 A
D1 Lightning impulse current (10/350 μs) (I <sub>imp</sub> )	1 kA	1 kA
C2 Nominal discharge current (8/20 μs) line-shield (I <sub>n</sub> )	5 kA	5 kA
Frequency range	0-300 MHz	0-300 MHz
Connection (input / output)	BNC socket / BNC socket	BNC socket / BNC socket
Approvals	CSA, UL	CSA, UL

**DGA TV**

DGA ... TV arresters with F connection for remote supply protect 75 ohm satellite and broadband cable systems and fulfil the high shielding requirements of class A according to EN 50083-2. They allow space-saving installation in all common TV and satellite applications and are available as lightning current arresters, surge arresters as well as combined lightning current and surge arresters with integrated measuring output for testing installations.



Type DGA ...	FF TV	GF TV	GFF TV
Part No.	909 703	909 704	909 705
SPD class	TYPE 3 P1	TYPE 1	TYPE 1 & TYPE 3 P1
Max. continuous operating voltage (d.c.) (U <sub>c</sub> )	24 V	60 V	24 V
Nominal current (I <sub>t</sub> )	2 A	2 A	2 A
D1 Lightning impulse current (10/350 μs) (I <sub>imp</sub> )	0.2 kA	2.5 kA	2.5 kA
C2 Nominal discharge current (8/20 μs) (I <sub>n</sub> )	1.5 kA	10 kA	10 kA
Frequency range	d.c. / 5-3000 MHz	0-2400 MHz	d.c. / 5-2400 MHz
Connection (input / output)	F socket / F socket	F socket / F plug	F socket / F socket
Approvals	EAC	EAC	EAC

**DGA F**

Quickly operating surge arrester for G.703 interfaces with low-capacitance diode matrix for optimised transmission performance. Earthing via enclosure. 1.6/5.6 connection.



Type DGA ...	F 1.6 5.6
Part No.	929 040
SPD class	TYPE 3 P1
Max. continuous operating voltage (d.c.) (U <sub>c</sub> )	6 V
Nominal current (I <sub>t</sub> )	0.25 A
C2 Nominal discharge current (8/20 μs) (I <sub>n</sub> )	0.3 kA
Frequency range	0-80 MHz
Connection	1.6/5.6 plug / 1.6/5.6 socket
Approvals	EAC

**DGA G**

Surge arrester with integrated gas discharge tube. Remote supply possible. SMA, BNC or N connection.



Type DGA ...	G SMA	G BNC	G N
Part No.	929 039	929 042	929 044
SPD class	TYPE 2	TYPE 2	TYPE 2
Max. continuous operating voltage (d.c.) (U <sub>c</sub> )	135 V	135 V	135 V
Nominal current (I <sub>t</sub> )	2 A	3.5 A	6 A
Max. transmission capacity	60 W	25 W	25 W
D1 Lightning impulse current (10/350 μs) (I <sub>imp</sub> )	1 kA	1 kA	1 kA
C2 Nominal discharge current (8/20 μs) (I <sub>n</sub> )	5 kA	5 kA	5 kA
Frequency range	0-5.8 GHz	0-4 GHz	0-5.8 GHz
Connection	SMA socket / SMA plug	BNC socket / BNC plug	N socket / N plug

### DGA AG

Lightning current arrester with replaceable gas discharge tube. Remote supply possible. BNC or N connection.

Type DGA ...	AG BNC	AG N
Part No.	929 043	929 045
SPD class	TYPE 1	TYPE 1
Max. continuous operating voltage (d.c.) ( $U_c$ )	180 V	180 V
Nominal current ( $I_L$ )	3.5 A	6 A
Max. transmission capacity	150 W	150 W
D1 Lightning impulse current (10/350 $\mu$ s) ( $I_{imp}$ )	5 kA	5 kA
C2 Nominal discharge current (8/20 $\mu$ s) ( $I_n$ )	20 kA	20 kA
Frequency range	0-1 GHz	0-2.5 GHz
Connection	BNC socket / BNC plug	N socket / N plug



### DGA LG

Quarterwave lightning current arrester combined with a spark gap for multi-frequency applications (e.g. LTE). Remote supply possible. 7/16 connection.

Type DGA ...	LG 7 16 MFA
Part No.	929 146
SPD class	TYPE 1
Max. continuous operating voltage (d.c.) ( $U_c$ )	65 V
Nominal current ( $I_L$ )	13 A
Max. transmission capacity	1500 W
D1 Lightning impulse current (10/350 $\mu$ s) ( $I_{imp}$ )	5 kA
C2 Nominal discharge current (8/20 $\mu$ s) ( $I_n$ )	20 kA
Frequency range	690 MHz-2.7 GHz
Connection	7/16 socket / 7/16 plug



### DGA L4

Combined lightning current and surge arrester with maintenance-free quarterwave technology and adapted frequency band. No remote supply possible. 7/16 connection.

Type DGA ...	L4 7 16 S	L4 7 16 MFA
Part No.	929 047	929 148
SPD class	TYPE 1 Pt	TYPE 1 Pt
Max. continuous operating voltage (d.c.) ( $U_c$ )	0 V	0 V
Nominal current ( $I_L$ )	0 A	0 A
Max. transmission capacity	3000 W	1500 W
D1 Lightning impulse current (10/350 $\mu$ s) ( $I_{imp}$ )	25 kA	40 kA
C2 Nominal discharge current (8/20 $\mu$ s) ( $I_n$ )	50 kA	80 kA
Frequency range	380-512 MHz	690 MHz-2.7 GHz
Connection	7/16 socket / 7/16 plug	7/16 socket / 7/16 plug



### DGA L4 N EB

Extremely broadband combined lightning current and surge arrester with maintenance-free quarterwave technology, adapted frequency band for Broadband Wireless Access applications and compact dimensions of the enclosure. No remote supply possible since the arrester represents an electrical short-circuit for low-frequency signals.

Type DGA ...	L4 N EB
Part No.	929 059
SPD class	TYPE 1 Pt
Max. continuous operating voltage (d.c.) ( $U_c$ )	0 V
Nominal current ( $I_L$ )	0 A
Max. transmission capacity	300 W
D1 Lightning impulse current (10/350 $\mu$ s) ( $I_{imp}$ )	25 kA
C2 Nominal discharge current (8/20 $\mu$ s) ( $I_n$ )	50 kA
Frequency range	2.0-6.0 GHz
Connection	N socket / N socket



**Gas Discharge Tube for DEHNgate**

Lightning current carrying replacement gas discharge tube for DEHNgate arresters. High quality with extremely low capacitance.



Type	GDT DGA 90	GDT DGA 230	GDT DGA 470
Part No.	929 497	929 498	929 499
Lightning impulse current carrying capability (10/350 µs)	5 kA	5 kA	5 kA

**Cable Lug with Earthing Conductor**

Cable lug with highly flexible black copper earthing conductor for earthing DEHNgate arresters (Part Nos. 929 043, 929 044 or 929 045).



Type	EL 16 B17
Part No.	929 096
Colour	black ●

**Earthing Block 4xF**

Four-pole earthing block with F sockets for equipotential bonding of satellite cable shields or DGA GF TV lightning current arresters.



Type	EB 4 F
Part No.	929 095
D1 Lightning impulse current (10/350 µs)	10 kA

**Angled Fixing Plate for DEHNgate**

Suitable for installing a DEHNgate arrester (Part Nos. 929 045, 929 146, 929 047, 929 148).



Type	BW90 B11 B5.1 6.5 11 V2A
Part No.	106 310
Material	stainless steel

**Angled Fixing Plate for DEHNgate**

Suitable for installing a DEHNgate arrester (Part Nos. 929 043 - 929 045), anti-rotation borehole (Ø16 mm).



Type	BW90 B16 B5.1 6.5 11 V2A
Part No.	106 314
Material	stainless steel

**Angled Fixing Plate for HF Arresters**

With three boreholes for three different sizes of DEHNgate, e.g. 1x 929 042 + 1x 929 057 + 1x (929 043, 929 044, 929 045 or 929 059).



Type	BW90 B17 21 16 V2A
Part No.	106 329
Material	stainless steel

**Equipotential Bonding Busbar for industrial Use**

Suitable for 3x DEHNgate (Part Nos. 929 045, 929 047, 929 146, 929 148, 929 446).



Type	PAS I 6AP M10 V2A
Part No.	472 209
Material	stainless steel

**Earthing Conductor, open / closed Cable Lugs**

Cable lug 1x open (M8/M10) and 1x closed (M8), can be combined with Part Nos. 106 310, 106 314, 106 329 and 472 209.



Type	EL16 L1.05M 1KSO 8.10 1KSG 8
Part No.	416 411
Colour	black ●





**FS / USD**

- Surge arrester with SUB-D connection for easy retrofitting
- 9-pin, 15-pin or 25-pin shielded types
- Arrester with single-stage (FS) or two-stage (USD) protective circuit



Surge arrester with SUB-D connection (socket / pin version). Alternative pinning available on request for the USD series.

The surge arresters are available in a shielded enclosure with SUB-D connection (socket / pin version). The UNC threaded screws of the FS surge arresters for protecting terminal equipment can be exchanged as required. The thread is thus situated either on the pin or socket side, depending on

the application. In switchgear cabinets, the powerful USD surge arrester can be snapped onto the DIN rail.

Special types with other pinning or circuits are also available.



SUB-D connection for easy installation.



The arrester is snapped onto a DIN rail. Overvoltage is discharged via the DIN rail.

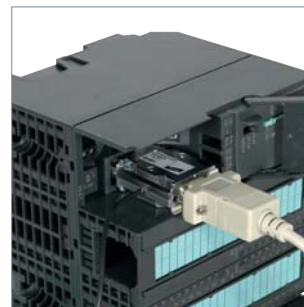

Direct connection to the device ensures optimal protection.



9-pin, 15-pin and 25-pin SUB-D version available.

**FS 9E PB**

Surge arrester for Profibus-DP. 9-pin SUB-D version, pin 6 unprotected for the programming interface.

Type	FS 9E PB 6
Part No.	924 017
SPD class	TYPE 4 Pt
Max. continuous operating voltage (d.c.) (U <sub>c</sub> )	7 V
C1 Nominal discharge current (8/20 μs) line-line (I <sub>nn</sub> )	0.2 kA
C1 Nominal discharge current (8/20 μs) line-SG (I <sub>ln</sub> )	0.2 kA
C1 Nominal discharge current (8/20 μs) SG-PG (I <sub>ln</sub> )	0.4 kA
Cut-off frequency (f <sub>c</sub> )	90 MHz
Connection (input / output)	SUB-D 9 plug / SUB-D 9 socket
Approvals	EAC

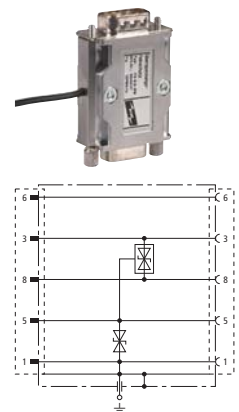

SPDs for SUB-D Connection

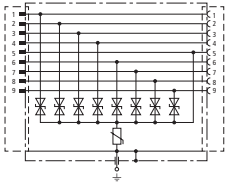

**FS 9E HS**

Surge arrester for V-24 interfaces with handshake. 9-pin SUB-D version.

Type	<b>FS 9E HS 12</b>
Part No.	<b>924 019</b>
SPD class	<b>TYPE 4 P1</b>
Max. continuous operating voltage (d.c.) (U <sub>c</sub> )	15 V
C1 Nominal discharge current (8/20 μs) line-SG (I <sub>n</sub> )	0.1 kA
C1 Nominal discharge current (8/20 μs) SG-PG (I <sub>n</sub> )	0.1 kA
Cut-off frequency (f <sub>c</sub> )	10 MHz
Connection (input / output)	SUB-D 9 plug / SUB-D 9 socket
Approvals	EAC

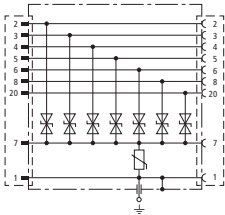

**FS 25E HS**

Surge arrester for V.24 interfaces with handshake. 25-pin SUB-D version.

Type	<b>FS 25E HS 12</b>
Part No.	<b>924 018</b>
SPD class	<b>TYPE 4 P1</b>
Max. continuous operating voltage (d.c.) (U <sub>c</sub> )	15 V
C1 Nominal discharge current (8/20 μs) line-SG (I <sub>n</sub> )	0.1 kA
C1 Nominal discharge current (8/20 μs) SG-PG (I <sub>n</sub> )	0.1 kA
Cut-off frequency (f <sub>c</sub> )	10 MHz
Connection (input / output)	SUB-D 25 plug / SUB-D 25 socket
Approvals	EAC

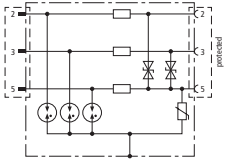

**USD 9 V24**

Energy-coordinated two-stage arrester for V.24 interfaces. 9-pin SUB-D version.

Type	<b>USD 9 V24 S B</b>
Part No.	<b>924 061</b>
SPD class	<b>TYPE 2 P1</b>
Max. continuous operating voltage (d.c.) (U <sub>c</sub> )	12.5 V
C2 Nominal discharge current (8/20 μs) line-PG (I <sub>n</sub> )	2.5 kA
C2 Nominal discharge current (8/20 μs) SG-PG (I <sub>n</sub> )	7.5 kA
Series resistance per line	15 ohms
Connection (input / output)	SUB-D 9 plug / SUB-D 9 socket
Approvals	EAC

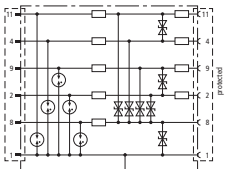

**USD 15 V11**

Energy-coordinated two-stage arrester for RS422, V.11 interfaces with diode protective circuit at the input. 15-pin SUB-D version.

Type	<b>USD 15 V11 S B</b>
Part No.	<b>924 051</b>
SPD class	<b>TYPE 2 P1</b>
Max. continuous operating voltage (d.c.) (U <sub>c</sub> )	8.5 V
C2 Nominal discharge current (8/20 μs) line-PG (I <sub>n</sub> )	2.5 kA
C2 Nominal discharge current (8/20 μs) SG-PG (I <sub>n</sub> )	7.5 kA
Series resistance per line	37 ohms
Connection (input / output)	SUB-D 15 plug / SUB-D 15 socket
Approvals	EAC

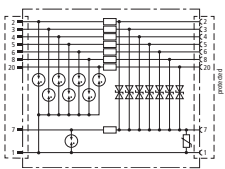







**USD 25 V24**

Energy-coordinated two-stage arrester for V.24 interfaces with handshake. 25-pin SUB-D version.

Type	<b>USD 25 V24 HS S B</b>
Part No.	<b>924 046</b>
SPD class	<b>TYPE 2 P1</b>
Max. continuous operating voltage (d.c.) (U <sub>c</sub> )	12.5 V
C2 Nominal discharge current (8/20 μs) line-PG (I <sub>n</sub> )	2.5 kA
C2 Nominal discharge current (8/20 μs) SG-PG (I <sub>n</sub> )	7.5 kA
Series resistance per line	15 ohms
Connection (input / output)	SUB-D 25 plug / SUB-D 25 socket
Approvals	EAC

## Shield Connection Systems and Enclosures

Product	Description	Type	Part No.	Page
<b>Shield connection on anchor bars</b>				
	<ul style="list-style-type: none"> <li>– Shield terminals for earthing cable shields on anchor bars</li> <li>– Different versions for different cable diameters</li> <li>– Lightning current carrying system</li> </ul>	SAK ... AS V4A	308 403 – 308 408	211
	<ul style="list-style-type: none"> <li>– Mounting rail for earthing and fixing shield terminals</li> <li>– Can be cut to length according to requirements</li> </ul>	AS SAK 1000 V2A	308 421	211
<b>Shield connection on DIN rails</b>				
	<ul style="list-style-type: none"> <li>– Shield terminals for earthing cable shields on DIN rails</li> <li>– Different versions for different cable diameters</li> <li>– Lightning current carrying system</li> </ul>	SAK 6.5 SN MS SAK 11 SN MS	919 010 919 011	212 212
	<ul style="list-style-type: none"> <li>– DIN rail mounted rail support</li> <li>– Low-impedance connection of the shield terminals to the DIN rail via the busbar</li> </ul>	SH1 18X3 ST SH2 18X3 ST	919 012 919 013	212 212
	<ul style="list-style-type: none"> <li>– Busbar for shield terminals</li> <li>– Can be mounted onto busbar supports</li> <li>– Can be cut to length according to requirements</li> </ul>	SN 18X3 CU 1000	919 016	212
<b>Shield connection for cables</b>				
	<ul style="list-style-type: none"> <li>– Constant force spring for solderless shield connection for equipotential bonding</li> <li>– Different versions for different cable diameters</li> <li>– Lightning current carrying system</li> </ul>	SA KRF ... V2A	919 031 – 919 038	213
<b>Enclosure</b>				
	<ul style="list-style-type: none"> <li>– Aluminium enclosure for DIN rail mounted devices</li> <li>– IP 65 degree of protection</li> <li>– Version for arresters for use in intrinsically safe measuring circuits Ex (i)</li> </ul>	ALGA 5 ALGA 5X	906 055 906 058	214 214

Shield Connection on Anchor Bars



- Lightning-impulse-current-tested up to 10 kA (10/350  $\mu$ s)
- Corrosion-resistant stainless steel
- Spring element ensures permanent shield connection

Lightning current carrying shield connection system for anchor bars. A slipping spring element compensates the yield of the cable materials used.

The lightning-impulse-current-tested shield connection system is specifically used on anchor bars. As, in the course of time, the cable materials are subject to a yield, this yield is compensated by a slipping spring element. The shield connection can also be isolated from local potential by means of an adequate insulating element.

This very robust shield connection system is particularly suited for cables with medium-sized diameters. It has been tested with lightning currents and is approved for nuclear plants.



Shield connection system on an anchor bar

## Shield Terminals

Shield terminals for earthing cable shields on anchor bars. Suitable for lightning equipotential bonding. Can be subsequently installed without interrupting the cable shield or requiring tools for installation. Approved for use in nuclear plants with TÜV test certificate ETL 10/PB 301/97 (TÜV = German Technical Inspectorate).

General technical data:			
Lightning impulse current carrying capability (10/350 µs)	10 kA		
Material	StSt		
For mounting on	anchor bars		
Approvals	ETL 10/PB 301/97		
Type	SAK 10 AS V4A	SAK 14 AS V4A	SAK 18 AS V4A
Part No.	308 403	308 404	308 405
Clamping range (Rd)	5-10 mm	8-14 mm	13-18 mm
Dimensions (W x L x H)	16 x 40 x 48 mm	19.5 x 40 x 50 mm	24 x 40 x 56 mm
Type	SAK 21 AS V4A	SAK 26 AS V4A	SAK 33 AS V4A
Part No.	308 406	308 407	308 408
Clamping range (Rd)	17-21 mm	19-26 mm	25-33 mm
Dimensions (W x L x H)	29 x 40 x 59 mm	36.5 x 40 x 74 mm	45 x 40 x 82 mm



## Anchor Bar

Mounting rail for earthing and fixing shield terminals.

Type	AS SAK 1000 V2A
Part No.	308 421
Material	StSt
Dimensions (W x L x H)	29 x 1000 x 15 mm
Approvals	ETL 10/PB 301/97



## Insulated Busbar Support

Insulated busbar support for fixing AS SAK 1000 V2A anchor bars, with M4 threaded bushing.

Type	ST AS SAK K
Part No.	308 425
Material	plastic
Approvals	ETL 10/PB 301/97



## Terminal

For connecting equipotential bonding conductors to AS SAK 1000 V2A anchor bars.

Type	AK 16 AS SAK MS
Part No.	308 411
Cross-sectional area, solid	16 mm²
For mounting on	anchor bars
Approvals	ETL 10/PB 301/97



## Shield Connection on DIN Rails



- Lightning-impulse-current-tested up to 5 kA (10/350  $\mu$ s)
- Corrosion-resistant stainless steel
- Spring element ensures permanent shield connection

The lightning-impulse-current-tested DIN rail mounted shield connection system for a wide range of applications is ideally suited for small cable diameters such as bus cables. As, in the course of time, the conductor materials are subject to a yield, this is compensated by a slipping spring element. The shield connection can also be isolated from local potential by means of an adequate insulating element.

Lightning current carrying DIN rail mounted shield connection system, ideally suited for small cables. Slipping spring element compensates the yield of the cable materials.



## Shield Terminals

For DIN rails

Type	SAK 6.5 SN MS	SAK 11 SN MS
Part No.	919 010	919 011
Lightning impulse current capacity (10/350 $\mu$ s)	5 kA	5 kA
Clamping range (Rd)	1.5-6.5 mm	5-11 mm
Material	nickel-plated brass	nickel-plated brass
For mounting on	SN 18x3 CU 1000	SN 18x3 CU 1000
Dimensions (W x L x H)	10 x 25 x 40 mm	17 x 25 x 47 mm



## Busbar

Mounting rail for shield terminals. Can be mounted onto busbar supports.

Type	SN 18X3 CU 1000
Part No.	919 016
Material	tin-plated copper
For mounting on	busbar supports
Dimensions (W x L x H)	18 x 1000 x 3 mm



## Rail Support with one-sided / two-sided Contact

Rail support suitable for DIN rail mounting. Low-impedance connection of the shield terminals to the DIN rail via the busbar.

Type	SH1 18X3 ST	SH2 18X3 ST
Part No.	919 012	919 013
Version	one-sided contact	two-sided contact
Material	tin-plated steel	tin-plated steel
For mounting on	35 mm DIN rails acc. to EN 60715	35 mm DIN rails acc. to EN 60715



## Insulated Rail Support

Insulated rail support for DIN rail mounting or screw connection.

Type	SH 18X3 K
Part No.	919 014
Material	plastic
Colour	black ●
For mounting on	DIN rails or mounting plates



## Terminal

Particularly suited for indirect shield earthing.

Type	AK 35 SN 18X3 GG
Part No.	919 015
Cross-sectional area	35 mm <sup>2</sup>
For mounting on	busbars

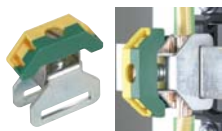



Shield Connection for Cables

- Lightning-impulse-current-tested up to 10 kA (10/350 μs)
- Extremely space-saving
- Spring element ensures permanent shield connection

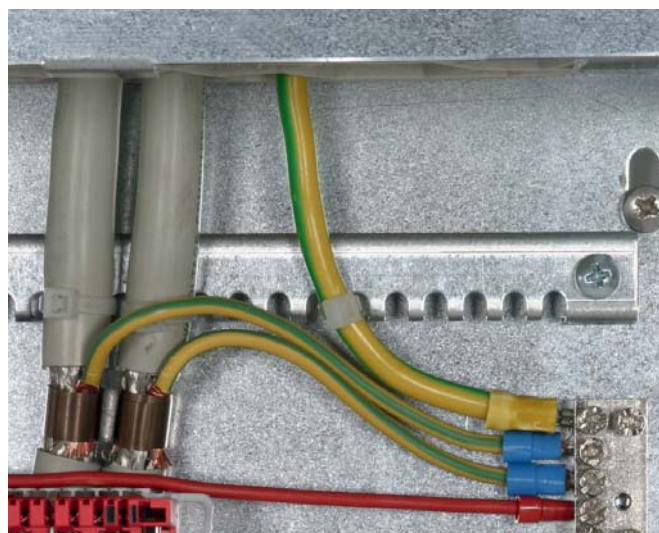

Extremely space-saving shield connection system for use as constant force spring. A spring element compensates the yield of the cable materials.



Test certificate for constant force spring of type SA KRF ...

The shields of the incoming information and power supply lines can be contacted by means of SA KRF constant force springs in a space-saving and lightning current carrying way. As, in the course of time, the conductor materials are subject to a yield, this yield is compensated by a spring element. To permanently protect the clamping point from corrosion, it is wrapped with a self-bonding SKB rubber tape.

Constant Force Spring

Constant force springs allow solderless shield connections for equipotential bonding or lightning equipotential bonding. They can be installed subsequently without interrupting the cable shield or requiring tools for installation. Approved for nuclear plants according to TÜV Certificate No. T12-04-ETL003 (TÜV = German Technical Inspectorate).

General Information:				
Lightning impulse current carrying capability (10/350 μs)	10 kA			
Colour	bare surface			
For mounting on	cable shields			
Approvals	T12-04-ETL003			
Type	SA KRF 10 V2A	SA KRF 15 V2A	SA KRF 22 V2A	SA KRF 29 V2A
Part No.	919 031	919 032	919 033	919 034
Clamping range (Rd)	4-10 mm	9-15 mm	14-22 mm	18.5-29 mm
Type	SA KRF 37 V2A	SA KRF 50 V2A	SA KRF 70 V2A	SA KRF 94 V2A
Part No.	919 035	919 036	919 037	919 038
Clamping range (Rd)	23.5-37 mm	31-50 mm	44-70 mm	58-94 mm



Self-bonding Rubber Tape

Roll with 9 m self-bonding rubber tape to be wrapped around constant force springs for permanent corrosion protection.

Type	SKB 19 9M SW
Part No.	919 030
Colour	black ●
Tape dimensions (W x L)	19 mm x 9 m



## Enclosure and Protective Conductor Terminal

- High-quality accessories
- Suitable for DIN rail mounted arresters

**Aluminium Enclosure**

For the installation of DIN rail mounted devices. With two M20 brass glands.

Type	ALGA 5
Part No.	906 055
Degree of protection	IP 65
For mounting on	walls
Dimensions (W x H x D)	100 x 200 x 81 mm
Enclosure material	Al

**Aluminium Enclosure for Ex(i) Surge Arresters**

With 4 plastic glands M20 x 1.5, sealable, pressure compensating grommets.



Type	ALGA 5 X
Part No.	906 058
Degree of protection	IP 65
For mounting on	walls
Dimensions (W x H x D)	160 x 100 x 85 mm
Enclosure material	Al

**Mounting Set**

For fixing ALGA 5 X enclosures at masts and pipes.

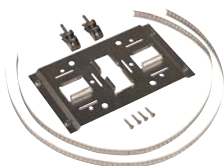

Type	MS ALGA 5 X
Part No.	906 059
For mounting on	masts, pipes with a diameter of 25-140 mm
Enclosure material	StSt

**Protective Conductor Terminal**

For earthing DIN rails.



Type	SLK 16
Part No.	910 099
Cross-sectional area, flexible	6-16 mm <sup>2</sup>
Cross-sectional area, solid	6-25 mm <sup>2</sup>
For mounting on	DIN rails acc. to EN 60715
Enclosure material	polyamide 6.6





**Condition Monitoring System with LifeCheck® Sensor**

- Permanent condition monitoring of LifeCheck-equipped arresters ensures a maximum degree of system protection and availability
- The early detection system already detects pre-damaged arresters and warns of imminent arrester failure
  - Visual indication of faulty or pre-damaged arresters
  - Compact dimensions and minimum wiring
  - Monitoring of up to ten arresters (40 signal cores)
  - Remote signalling contact
  - Remote monitoring also via RS485 interface and PC software (DRC MCM XT)



Installed DEHNrecord condition monitoring system

**Condition monitoring**

The DRC MCM XT and DRC SCM XT condition monitoring systems are compact DIN rail mounted devices designed for condition monitoring of up to 10 pre-programmed BXT/BXTU arresters with an integrated LifeCheck monitoring circuit.

Integrated into the protection modules, LifeCheck permanently monitors the condition of the arrester and acts like an early warning system, detecting imminent electrical or thermal overload of the protection components. The LifeCheck status can be read via non-contact RFID technology. Stationary installed, a single condition monitoring unit allows condition-based maintenance of 10 BXT/BXTU arresters.

The unit acts like an early warning system, generating a fault message already in case of imminent arrester overload. This fault message is indicated by an integrated three-coloured LED and transmitted via an integrated remote signalling contact. Failure of the monitoring unit, e.g. due to a voltage breakdown, is also indicated via the remote signalling contact.

The Show function integrated in the DRC MCM XT and DRC SCM XT system allows to detect pre-damaged arresters in the monitoring group.

The DRC SCM XT device is ideally suited for small-sized installations and allows to monitor up to 10 protection modules with integrated LifeCheck. In case of larger installations with more than 10 arresters, the DRC MCM XT device with integrated RS485 interface is used. The condition monitoring units are connected via the integrated RS485 interfaces to synchronise the monitoring cycles. Up to 15 DRC MCM systems can be connected to one another at the RS485 bus, allowing up to 150 BLITZDUCTOR modules or 300 pairs to be monitored simultaneously with minimum wiring effort.

**The “Status Display and Service Console” PC software**

is optionally available for the DRC MCM XT condition monitoring system. It equippes the status of the arresters and addresses the LifeCheck-equipped BLITZDUCTOR modules.

The software can be installed on a standard PC using an RS485 / USB interface converter of type “USB-NANO 485” which is available as accessory.

The software can be downloaded free of charge at [www.dehn-international.com](http://www.dehn-international.com) or is available as CD for a nominal fee.



Integrated visual operating state indication with three-colour LED.



Floating remote signalling contact  
 DRC MCM XT: break contact (21/22)  
 make contact (13/14)  
 DRC SCM XT: break contact (21/22)



RS485 communications interface  
 A/B (only for DRC MCM XT) for large installations.

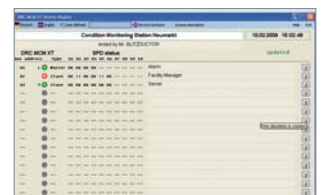

Online monitoring via free software (only for DRC MCM XT).

**DRC MCM XT**

DIN rail mounted device with integrated LifeCheck sensor for condition monitoring of max. ten LifeCheck-equipped BLITZDUCTOR XT/XTU arresters. A three-coloured LED and a remote signalling contact (break or make contact) indicate the operating state of the arrester. The free “Status Display and Service Console” software can be optionally used via an RS485 interface converter. The software allows to remotely indicate the condition of all monitored arresters by means of a PC. Download: [www.dehn-international.com](http://www.dehn-international.com)

Type DRC ...	MCM XT
Part No.	910 695
Input voltage range (d.c.) (U <sub>IN</sub> )	18-48 V
Max. rated current consumption (I <sub>IN</sub> )	100 mA
RFID transmission frequency	125 kHz
Type of remote signalling contact	make (no) and break contact (nc)
Delivery includes	base part, monitoring module, quick guide and labelling system

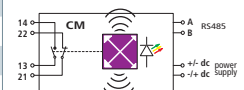

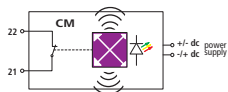

**DRC SCM XT**

DIN rail mounted device with integrated LifeCheck sensor for condition monitoring of up to ten LifeCheck-equipped BLITZDUCTOR XT/XTU arresters. Visual operating state indication via three-colour LED combined with remote signalling function (break contact).

Type DRC ...	SCM XT
Part No.	910 696
Input voltage range (d.c.) ( $U_{IN}$ )	18-48 V
Max. rated current consumption ( $I_{IN}$ )	100 mA
RFID transmission frequency	125 kHz
Type of remote signalling contact	break contact (nc)
Delivery includes	base part, monitoring module, quick guide and labelling system

**Accessories for Condition Monitoring System with LifeCheck® Sensor**

**DIN Rail mounted Power Supply Unit**

High-performance DIN rail mounted power supply unit with single-phase wide-range input can be connected to different supply systems. The operating state indicator on the front panel indicates that the output voltage is present. Up to 10 DRC MCM XT or DRC SCM XT (single application) or up to 15 DRC MCM XT monitoring devices (multiple application) can be connected to a single power supply unit.



Type	PSU DC24 30W
Part No.	910 499
Input voltage range	85-264 V a.c.; 120-373 V d.c.
Frequency	44-66 Hz; 0 Hz
Input current ( $I_e$ )	0.7 A at 110 V a.c. / 0.5 A at 230 V a.c.
Nominal output voltage ( $U_a$ )	24 V d.c. (SELV)
Output current ( $I_a$ )	1.3 A at 24 V d.c., max. 0.9 A in any installation position
Recommended backup fuse	circuit breaker 10 A, 16 A, characteristic B, C
Standards / regulations	EN 60950, EN 61204-3, UL 60950, UL 508, GL

**USB Interface Converter of Type USB-NANO-485**

USB-Nano-485 converts between USB and RS485 signals and is specifically designed for two-wire RS-485 buses. LEDs indicate the operating state (yellow), Rx (green) and Tx (red). Due to its compact dimensions, USB-Nano-485 is ideally suited for use with notebooks, however, stationary use is also possible.



Type	USB NANO 485
Part No.	910 486
Version	with LED indication

**Status Center Software CD for DRC MCM XT**

Status Center software for starting and managing up to 20 instances of the "Status Display with integrated Service Console" DRC MCM XT monitoring software. Monitoring and status indication of up to 3000 BLITZDUCTOR XT/XTU LifeCheck modules in up to 20 DRC MCM XT monitoring systems (15 DRC MCM XT each with RS485 bus wiring).



Type	SWP MCM ST CENTER
Part No.	910 489
For	up to 3000 BLITZDUCTOR XT

**Labelling System BA1-BA15**

2x 165 adhesive labels for labelling DRC MCM XT monitoring devices with the bus address.

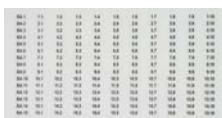

Type	BS BA1 BA15 BXT
Part No.	920 398
Colour	transparent

**Partition**

Allows to position BXT devices for non-intrinsically safe circuits directly next to intrinsically safe circuits (thread measure  $\geq 50$  mm). For DRC MCM XT and DRC SCM XT; 1 set = 2 pieces.



Type	TW DRC MCM EX
Part No.	910 697
Colour	blue ●



**LifeCheck® SPD Test Devices**

- SPD test device for preventive maintenance
  - The LifeCheck monitoring device detects thermal or electrical overload conditions of all components
  - To avoid imminent failure and thus system downtime, the protection module should be replaced as soon as possible
- Benefits of this type of SPD testing:
  - Extremely easy and within a matter of seconds
  - Module does not have to be removed, testing during system operation
  - Detection of thermal or electrical pre-damage of all components



Maintenance tests and test intervals for lightning protection systems are specified in DIN EN 62305-3, supplement 3 (see table excerpt). However, these periods are only standard-based minimum requirements.

Class of LPS	Visual inspection	Complete inspection	Complete inspection of critical systems
I and II	1 year	2 years	1 year
III and IV	2 years	4 years	1 year

Visual inspections of arresters for information technology systems do not make sense since the status of the devices is not generally visible. For this purpose, another method has to be chosen as is the case with complete inspections. In the past, measurement equipment was used to test arresters. These measurements were very time consuming, required expertise and did not provide sufficient information.

**Preventive maintenance:**

With this maintenance strategy, arresters are tested and measured at regular intervals. They are assessed according to predetermined criteria and, if required, replaced.

In the past, this procedure was very time consuming, expensive and required disconnection of the system.

LifeCheck-equipped arresters have been available for some years now,

allowing to determine the status of the arrester via RFID technology. A monitoring circuit with a transponder integrated the arrester permanently monitors the protective circuit for impermissible overload caused by overheating or impulse currents.

Information is read via a hand-held tester which houses the RFID reader. It contactlessly transmits electromagnetic energy to the transponder in the SPD, reads out its status and displays it. Information is simple: "SPD OK" or "Replace SPD!". This test is carried out easily within a matter of seconds without removing the SPD. It can be carried out at any time without downtime since signal transmission is not interrupted.

This type of monitoring reliably detects thermal and electrical overload of all components, typically before the arrester fails and the availability of the system to be protected is limited. In addition, no expertise is required for testing. The reader also facilitates documentation of the test results which is mandatory in compliance with the EN 62305-3 standard.

The test data (date, time, results) of all arresters are saved and can be transmitted to a PC via a USB interface for printing or storage.

Consequently, a higher degree of protection and availability is achieved by means of LifeCheck-based preventive maintenance since overload of components is already detected before the protection of the system circuit fails.

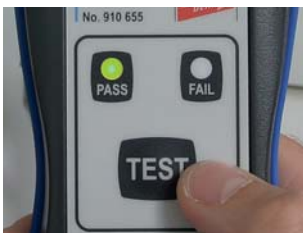

Intuitive operation and fast arrester testing (M1+).



Hand-held snap-on sensor.



Interval testing with DRC LC M3+.

Test 01		
Status	Uhrzeit letzte Prüfung	Datum letzte Prüfung
*ok	11:41:34	26.08.15
*ok	11:41:54	26.08.15
*ok	11:42:12	26.08.15
*ok	11:42:32	26.08.15
*ok	11:42:54	26.08.15
*ok	11:43:10	26.08.15
*ok	11:43:29	26.08.15
*ok	11:43:50	26.08.15
*ok	11:44:08	26.08.15

Database function in case of DRC LC M3+.

## Measuring and Test Devices



### DRC LC M3+

Portable device with LifeCheck sensor for flexible use. Fast and easy testing of LifeCheck-equipped arresters. Visual and acoustic indication. With additional USB connection and database software for PC-aided management of test samples and documentation of the test results. The DRC LC M3+ features a snap-on LifeCheck sensor. The hand-held device allows parameterisation of arresters for condition monitoring.

Type DRC LC ...	M3+
Part No.	910 653
Voltage supply (included in delivery)	lithium-ion battery
RFID transmission frequency	125 kHz
Measured value indication	beep and LCD
Delivery includes	hand-held device, BXT LifeCheck sensor, battery charger, USB cable, test module for reference, software CD, storage case
Dimensions of the storage case	340 x 275 x 83 mm



### DRC LC M1+

Portable device with LifeCheck sensor for flexible use. Fast and easy testing of LifeCheck-equipped arresters. The result of the LifeCheck test, the operating state of the device and the battery status are indicated via LEDs. The DRC LC M1+ features a snap-on LifeCheck sensor.

Type DRC LC ...	M1+
Part No.	910 655
Voltage supply (included in delivery)	lithium-polymer battery
RFID transmission frequency	125 kHz
Measured value indication	LED
Delivery includes	hand-held device, BXT LifeCheck sensor, power supply unit with country-specific adapters, USB cable, test module for reference, storage case
Dimensions of the storage case	275 x 230 x 83 mm

## Accessories for LifeCheck® SPD Test Devices

### LifeCheck Sensor for DRC BXT

Snap-on LifeCheck sensor and test module for use as spare part / extension for portable LifeCheck test devices.



Type	LCS DRC BXT
Part No.	910 652
For testing	BLITZDUCTOR XT ML



**SPD Test Device**

- For routine tests of surge protective devices
- Compact dimensions
- Suitable for mains and battery operation
- Low battery indicator
- Test leads included in delivery
- Shock-proof test adapter available as accessory



For testing the sparkover voltage of surge arresters. The specimen is connected via the included test leads or special test adapters.

The PM 20 SPD test device with integrated sparkover detection is used to test Yellow/Line and Red/Line surge arresters with integrated varistor, Zener diode or gas discharge tube. Both the sparkover performance between the connections of the arresters as well as the continuity can be tested. The results can be compared to the limit values specified in the

instructions for use. In case of deviations, the arrester or protection module must be replaced. Test adapters with a corresponding support make it easier to test arresters of the BLITZDUCTOR XT and DEHNrapid LSA product family.

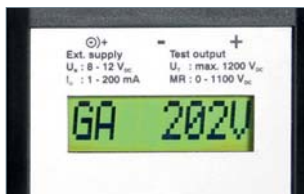

Indication of the measured sparkover voltage.



The sparkover performance of gas discharge tubes, varistors and Zener diodes can be tested.



Insulated test leads included in delivery.



Can be directly connected to a test adapter for easy testing of DRL or BXT protection modules.

**PM 20**

Combined device for testing the sparkover voltage of surge arresters (with gas discharge tubes / varistors / Zener diodes). Storage bag and measuring accessories included.

Type	PM 20
Part No.	910 511
Nominal voltage (d.c.) (U <sub>N</sub> )	8-12 V d.c.
Test parameter: Test voltage	max. 1250 V d.c.
Measured value indication	alphanumeric, eight-digit LCD
Accessories included in delivery	2 test leads (each 1 m long), 2 safety tapping test clips, 1 plug-in power supply unit (230 V a.c.), 1 storage bag
Dimensions of the storage bag	300 x 110 x 110 mm



**Accessories for SPD Test Device**

**PA DRL Test Adapter**

To be connected to PM 10 / PM 20. For inserting and testing protection modules.

Type	PA DRL
Part No.	910 507
For protection modules	DEHNrapid LSA and DPL



**PA BXT Test Adapter**

To be connected to PM 10 / PM 20. For inserting and testing protection modules.

Type	PA BXT
Part No.	910 508
For protection modules	BLITZDUCTOR XT / SP / CT



DEHN protects.



DEHNrecord  
DRC MCM XT  
No. 910 695

**BLITZDUCTOR**  
BXT ML4 BD  
EX 24  
No. 920 381  
 $U_c$  33 V  
 $U_w$  24 V  
 $I_{imp}$  0.5 A/80

**BLITZDUCTOR**  
BXT ML2 BE  
EX 24  
No. 920 224  
protected lines 1/2  
 $U_c$  33 V  
 $I_{imp}$  2,5/9 kA  
 $U_w$  24 V

DEHN  
rapid  
LSA

DEHN  
DPA M U  
RJ45B 48  
No. 929 121  
 $U_c$  48 V  
SPD  
TYPE 2 Pd

# LIGHTNING EQUIPOTENTIAL BONDING

Isolating Spark Gaps and Components





TFS / KFSU



- For indirect connection/earthing of functionally isolated parts of installations under lightning conditions
- For lightning equipotential bonding according to IEC 62305
- With corrosion-resistant stainless steel connections
- For installation in buildings, outdoor locations and damp rooms as well as for underground installation
- Extremely heavy-duty devices

TFS: High-capacity isolating spark gap  
 KFSU: Isolating spark gap

For lightning equipotential bonding according to IEC 62305 as well as for use in IT installations according to IEC 60364-5-54.

TFS / KFSU

Isolating spark gaps with plastic sheath and two stainless steel connections (Rd 10 mm).



Type	TFS	KFSU
Part No.	923 023	923 021
Isolating spark gap according to EN 62561-3 / IEC 62561-3	yes	yes
Lightning impulse current (10/350 $\mu$ s) ( $I_{imp}$ )	100 kA	—
Class (lightning current carrying capability)	H	—
Rated impulse sparkover voltage ( $U_{r imp}$ )	$\leq 4$ kV	$\leq 4$ kV
Degree of protection protection	IP 65	IP 65





**EXFS L / EXFS KU**

- For indirect connection/earthing of functionally isolated parts of installations under lightning conditions
- For lightning equipotential bonding according to IEC 62305 in hazardous areas (zone 2)
- Corrosion-resistant zinc die-cast enclosure with plastic cover and flexible cable connection
- For bridging insulating joints, insulating flanges etc. in cathodically protected pipe sections
- Extremely heavy-duty device
- Approval according to ATEX directive 94/9/EC and IECEx



ATEX and IECEx-certified isolating spark gap for lightning equipotential bonding according to IEC 62305 with flexible cable connection.

**EXFS L ...:** Isolating spark gap for use in hazardous areas with flexible connecting cable

**EXFS KU:** Isolating spark gap for use in hazardous areas with two 1.5 m long connecting cables for underground installation

Ex isolating spark gaps of the EXFS L / EXFS KU product line are used when electrically conductive parts of installations cannot be directly interconnected in hazardous areas, for example, in case of cathodically protected pipeline sections.

ATEX and IECEx-certified EXFS L and EXFS KU spark gaps provide approved safety in accordance with harmonised European standards. The arc-resistant tungsten / copper electrodes ensure a long service life of the Ex spark gaps.

The approved EXFS L type with flexible cable connection quickly adapts to any application environment. The prewired spark gaps feature connecting cables of different lengths with cable lug, screw and M10 nut. The flat or angled connection brackets (IF), which are available as accessory, allow to easily connect the spark gap to pipeline flanges.

The EXFS KU type is enclosed by a water-proof PVC sheath and is thus ideally suited for underground installation on insulating couplings.

**EXFS L**

Ex isolating spark gap for aboveground installation.

Type EXFS ...	L100	L200	L300
Part No.	923 060	923 061	923 062
Isolating spark gap according to EN 62561-3 / IEC 62561-3	yes	yes	yes
Lightning impulse current (10/350 μs) (I <sub>imp</sub> )	50 kA	50 kA	50 kA
Class (lightning current carrying capability)	N	N	N
Rated impulse sparkover voltage (U <sub>r imp</sub> )	≤ 2.5 kV	≤ 2.5 kV	≤ 2.5 kV
Degree of protection	IP 54	IP 54	IP 54
ATEX approvals	DEKRA 11ATEX0146 X	DEKRA 11ATEX0146 X	DEKRA 11ATEX0146 X
Ex marking according to EN 60079-0 and EN 60079-15: gas	II 3 G Ex nC IIC T4 Gc	II 3 G Ex nC IIC T4 Gc	II 3 G Ex nC IIC T4 Gc
IECEx approvals	IECEx DEK 11.0063X	IECEx DEK 11.0063X	IECEx DEK 11.0063X
Ex marking according to EN 60079-0	Ex nC IIC T4 Gc	Ex nC IIC T4 Gc	Ex nC IIC T4 Gc
Cable length	100 mm	200 mm	300 mm



**EXFS KU**

Ex isolating spark gap with connecting cables for aboveground and underground installation; with water-proof sheath; can be shortened for short cable lengths.

Type EXFS ...	KU
Part No.	923 019
Isolating spark gap according to EN 62561-3 / IEC 62561-3	yes
Lightning impulse current (10/350 μs) (I <sub>imp</sub> )	50 kA
Class (lightning current carrying capability)	N
Rated impulse sparkover voltage (U <sub>r imp</sub> )	≤ 2.5 kV
Degree of protection	IP 67
ATEX approvals	DEKRA 11ATEX0146 X
Ex marking according to EN 60079-0 and EN 60079-15: gas	II 3 G Ex nC IIC T4 Gc
IECEx approvals	IECEx DEK 11.0063X
Ex marking according to EN 60079-0	Ex nC IIC T4 Gc
Cable length	2x approx. 1500 mm





EXFS 100 / EXFS 100 KU



ATEX and IECEx-certified isolating spark gap with a low sparkover voltage for lightning equipotential bonding according to IEC 62305.

The Ex isolating spark gaps of the EXFS 100 / EXFS 100 KU product family are used when conductive installation parts situated in hazardous areas cannot be directly interconnected.

The spark gaps with low sparkover voltage are especially efficient for isolated parts of installations with low insulation strength.

No special requirements have to be observed for safe installation in zone 1 (gases) or zone 21 (dusts).

With a maximum lightning impulse current of 100 kA (10/350 µs), EXFS 100 and EXFS 100 KU meet class H requirements (highest lightning current carrying capability class).

- For indirect connection/earthing of functionally isolated parts of installations under lightning conditions
- Device for lightning equipotential bonding according to IEC 62305 in hazardous areas
- For bridging insulating joints, insulating flanges, etc. in cathodically protected pipe sections
- For safe installation in Ex zone 1 (gas) or 21 (dust)
- Extremely low sparkover voltage
- Extremely high alternating current withstand capability
- Approval according to ATEX directive 94/9/EC and IECEx

**EXFS 100:** Isolating spark gap for use in hazardous areas with plastic sheath and M10 threaded bushings

**EXFS 100 KU:** Isolating spark gap for use in hazardous areas with two 2 m long connecting cables for underground installation

The ATEX and IECEx-certified EXFS 100 and EXFS 100 KU spark gaps provide approved safety according to harmonised European standards.

For connecting EXFS 100 spark gaps, prewired connecting cables of different lengths are available as accessory.

Flat and angled connection brackets (IF) allow to easily connect the spark gaps to pipeline flanges.

EXFS 100 KU types are enclosed by a water-proof plastic sheath and are therefore ideally suited for underground installation on insulating couplings.

**EXFS 100**

Isolating spark gap for use in hazardous areas with plastic sheath and M10 threaded screws.



Type EXFS ...	100
Part No.	923 100
Isolating spark gap according to EN 62561-3 / IEC 62561-3	yes
Lightning impulse current (10/350 µs) (I <sub>imp</sub> )	100 kA
Class (lightning current carrying capability)	H
Rated impulse sparkover voltage (U <sub>r imp</sub> )	≤ 1.25 kV
Degree of protection	IP 67
ATEX approvals	DEKRA 11ATEX0178 X
Ex marking according to EN 60079-0 and EN 60079-1: gas	II 2 G Ex d IIC T6 Gb
Ex marking according to EN 60079-0 and EN 60079-31: dust	II 2 D Ex tb IIIC T80 °C Db IP 66/67
IECEx approvals	IECEx KEM 09.0051X
Ex marking according to EN 60079-0 and EN 60079-1: gas	Ex d IIC T6 Gb
Ex marking according to EN 60079-0 and EN 60079-31: dust	Ex tb IIIC T80 °C Db IP 66/67

**EXFS 100 KU**

Ex isolating spark gap with connecting cable for aboveground and underground installation; with water-proof sheath; can be shortened for short cable lengths.



Type EXFS ...	100 KU
Part No.	923 101
Isolating spark gap according to EN 62561-3 / IEC 62561-3	yes
Lightning impulse current (10/350 µs) (I <sub>imp</sub> )	100 kA
Class (lightning current carrying capability)	H
Rated impulse sparkover voltage (U <sub>r imp</sub> )	≤ 1.25 kV
Degree of protection	IP 67
ATEX approvals	DEKRA 11ATEX0178 X
Ex marking according to EN 60079-0 and EN 60079-1: gas	II 2 G Ex d IIC T6 Gb
Ex marking according to EN 60079-0 and EN 60079-31: dust	II 2 D Ex tb IIIC T80 °C Db IP 66/67
IECEx approvals	IECEx KEM 09.0051X
Ex marking according to EN 60079-0 and EN 60079-1: gas	Ex d IIC T6 Gb
Ex marking according to EN 60079-0 and EN 60079-31: dust	Ex tb IIIC T80°C Db IP 66/67
Cable length	2x approx. 2000 mm

### Angled Connection Brackets – IF 1 –

Angled connection bracket for EXFS ...; diameter corresponds to the bolt diameter of the flange joint; material: St/tZn.

Type	AB EXFS IF1 W 11	AB EXFS IF1 W 14	AB EXFS IF1 W 18	AB EXFS IF1 W 22
Part No.	923 311	923 314	923 318	923 322
Borehole diameter d1	11 mm	14 mm	18 mm	22 mm
Type	AB EXFS IF1 W 26	AB EXFS IF1 W 30	AB EXFS IF1 W 33	
Part No.	923 326	923 330	923 333	
Borehole diameter d1	26 mm	30 mm	33 mm	
Type	AB EXFS IF1 W 36	AB EXFS IF1 W 39	AB EXFS IF1 W 42	
Part No.	923 336	923 339	923 342	
Borehole diameter d1	36 mm	39 mm	42 mm	
Type	AB EXFS IF1 W 48	AB EXFS IF1 W 56	AB EXFS IF1 W 62	
Part No.	923 348	923 356	923 362	
Borehole diameter d1	48 mm	56 mm	62 mm	



### Flat Connection Brackets – IF 3 –

Flat connection bracket for EXFS ...; diameter corresponds to the bolt diameter of the flange joint; material: St/tZn.

Type	AB EXFS IF3 G 11	AB EXFS IF3 G 14	AB EXFS IF3 G 18	AB EXFS IF3 G 22
Part No.	923 211	923 214	923 218	923 222
Borehole diameter d1	11 mm	14 mm	18 mm	22 mm
Type	AB EXFS IF3 G 26	AB EXFS IF3 G 30	AB EXFS IF3 G 33	
Part No.	923 226	923 230	923 233	
Borehole diameter d1	26 mm	30 mm	33 mm	
Type	AB EXFS IF3 G 36	AB EXFS IF3 G 39	AB EXFS IF3 G 42	
Part No.	923 236	923 239	923 242	
Borehole diameter d1	36 mm	39 mm	42 mm	

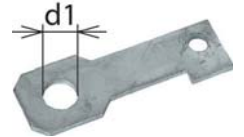

### EXFS 100: Connecting Cable, Cu, 25 mm<sup>2</sup>

Connecting cable for EXFS 100; two cable lugs (Ø10.5 mm) made of Cu/gal Sn, screw, nut, and spring washer.

Type	AL EXFS L100 KS	AL EXFS L200 KS	AL EXFS L300 KS
Part No.	923 025	923 035	923 045
Cable length	100 mm	200 mm	300 mm





EXFS Coaxial Connection Box



Coaxial connection of the Ex isolating spark gap for protecting buried insulating joints

- Voltage drop on the connecting cable is up to three times lower than in case of a conventional connecting cable
- Version for lightning equipotential bonding according to IEC 62305 in hazardous areas
- For bridging insulating joints in cathodically protected pipe sections of pipelines
- Easy inspection and exchange of the spark gap without excavation work

NAK SN4631: Coaxial connection box with integrated Ex isolating spark gap EXFS 100

The coaxial connection box with integrated Ex isolating spark gap EXFS 100 protects buried insulating joints and flanges, e.g. when bridging insulating joints in cathodically protected pipe sections.

The insulating joint or flange is connected to the coaxial connection box via a coaxial connecting cable, thus achieving an up to three times better protective effect than in case of a conventional connecting cable of comparable length. Consequently, the coaxial connection box has the advantage that the insulation strength of the insulating joint is not exceeded even in case of long connecting cables. Moreover, this solution allows to easily inspect the Ex isolating spark gap EXFS 100, even if it is installed underground.

The coaxial connection box is supplied with all necessary fixing and assembly accessories, thus ensuring easy installation.

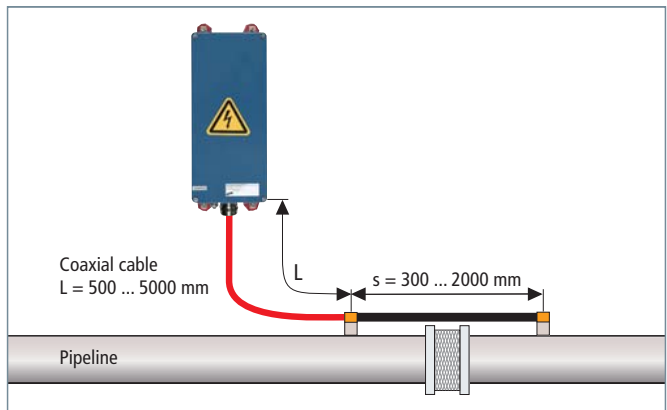

Application example NAK SN4631

**NEW**



Coaxial Connection Box with EXFS 100

Coaxial connection of isolating spark gaps with a low sparkover voltage for lightning equipotential bonding according to IEC 62305.

Type	NAK SN4631
Part No.	999 990 <b>NEW</b>
Isolating spark gap acc. to EN 62561-3 / IEC 62561-3	yes
Lightning impulse current (10/350 μs) (I <sub>imp</sub> )	100 kA
Nominal discharge current (8/20 μs) (I <sub>n</sub> )	100 kA
Rated impulse sparkover voltage (U <sub>r imp</sub> )	≤ 1.25 kV
Degree of protection protection	IP 67 (UV-resistant)



### Intelligent d.c. coupling device VCSD

- Protection in case of transient, temporary and long-duration overvoltages
- Does not negatively affect cathodic protection equipment
- Adjustable response threshold for flexible use in a wide range of application and operating states



VCSD 40 IP65 – “intelligent coupling device”

### VCSD 40 IP65: Voltage-controlled short-circuiting device with adjustable response threshold

The “intelligent” decoupling device VCSD 40 IP65 is a short-circuiting switch which is controlled by overvoltage and limits long-duration, temporary and transient overvoltages. With the exception of direct currents, the VCSD is capable of discharging all interference voltages and limiting them to a preset value without negatively affecting the d.c. potential (cathodic protection potential). It limits the effects of dangerous high overvoltages in its immediate vicinity to a safe level.

#### Limiting behaviour of VCSD 40 IP65 in the time range

Transient overvoltages are limited to values  $< 1.25$  kV (time range: up to 1 ms).

Temporary overvoltages are limited to values  $< 940$  V depending on the duration (time range: 1 ms to 200 ms).

Long-duration overvoltages are limited to values between 3 and 50 V a.c. (adjustable) (time range:  $> 200$  ms).

#### Functional description

Thanks to the coordinated and tested interaction of the functional units within the VCSD, the following overvoltage-related effects can be prevented:

#### Undefined, lightning-related puncture and flashover at insulating clearances

Lightning-related overvoltage is limited and the associated lightning currents are discharged to local earth.

#### Dangerous touch voltages at accessible places

Dangerous touch voltages are limited below the maximum permissible touch voltage for the duration of their occurrence.

#### Reduction of a.c. corrosion caused by a.c. interference

Technical alternating currents between 16.7 Hz and 60 Hz can be permanently discharged to low-impedance earth electrodes without negatively affecting the cathodic protection potential on long-distance pipelines.

#### Monitoring / controlling

Due to the digital and analogue interfaces, the VCSD 40 IP65 can be externally controlled, device faults can be displayed and discharge currents can be signalled in the form of a 4 – 20 mA signal (scaled to 0 – 40 A).

#### Fields of application

The VCSD 40 IP65 is ideally suited for pipelines which are interfered by lightning strikes, electric railways or high-voltage lines. Typical fields of application are remote insulated pipeline sections, cathodically protected containers / storage tanks, open earthing of cable shields at accessible places or the corrosion-free interconnection of isolated earth-termination systems such as foundation earth electrodes of a building and an isolated signal ground or railway earth electrode.

Advantages of the VCSD 40 IP65 are the flexible and controllable use in different fields of application, the high discharge capacity as well as a tested, comprehensive, coordinated protection solution from the surge protection specialist DEHN.

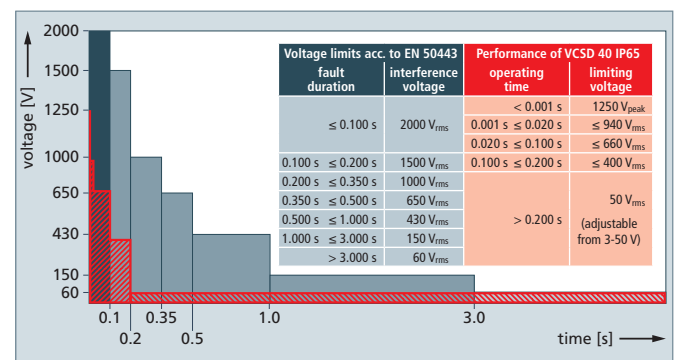

Limiting behaviour of the VCSD

**NEW**

### VCSD 40 IP65

Voltage-controlled short-circuiting device with adjustable response threshold for flexible use in a wide range of systems.



Type	VCSD 40 IP65
Part No.	923 401 <small>NEW</small>
Transient discharge current (10/350 µs)	100 kA
Transient discharge current (8/20 µs)	100 kA
Temporary discharge current (16.7 Hz, 50 Hz, 60 Hz)	1.1 kA <sub>rms</sub> (up to 200 ms) * <sup>1)</sup>
Temporary discharge current (16.7 Hz, 50 Hz, 60 Hz)	500 A <sub>rms</sub> (up to 1 s)
Long-duration discharge current (16.7 Hz, 50 Hz, 60 Hz)	40 A <sub>rms</sub> (permanently) * <sup>2)</sup>
Long-duration limiting voltage (a.c.rms) (> 200 ms)	max. 50 V (adjustable from 3 to 50 V)
Degree of protection	IP 65
Dimensions	400 x 300 x 150 mm

\*<sup>1)</sup> Derating depends on the "biasing current" (long-duration discharge current) and on the ambient temperature

\*<sup>2)</sup> Derating depends on the ambient temperature

See instructions for use and installation instructions

## Accessories for Voltage Controlled Short-Circuiting Device

### DGP M – 100 kA N-PE Spark-Gap-Based Protection Module

N-PE spark-gap-based protection module for all devices of the modular DEHNgap M family.



Type	DGP M MOD 255
Part No.	961 010
Max. continuous operating voltage (a.c.) (U <sub>c</sub> )	255 V

**NEW**



### EB 9V LI Block Battery

Type	EB 9V LI1300 80
Part No.	923 099 <small>NEW</small>
Type	9 V block battery, lithium



Pipe Clamps for Hazardous Areas Zone 1/21, 2/22

- For use in explosion-hazardous areas Ex zones 1 and 2 (gases, vapours, mists) as well as Ex zones 21 and 22 (dusts)
- Tested according to explosion group IIB
- Time-saving installation – no need to deactivate systems/areas for welding or drilling works

EX BRS 27: Clamping range of Ø6-27 mm (3/4")  
 EX BRS 90: Clamping range of Ø27 (3/4") to 89 mm (3")  
 EX BRS 300: Clamping range of Ø89 (3") to 300 mm  
 EX BRS 500: Clamping range of Ø300 to 500 mm  
 Separate clamping body: Clamping range of Ø27 (3/4") to 500 mm



Pipe clamp for electrical contacting of pipes in explosion-hazardous areas for implementing of lightning equipotential bonding according to IEC/EN 62305-3

So far equipotential bonding and lightning equipotential bonding of pipes in explosion-hazardous areas have been implemented by means of welded or threaded bushing connections. Clamps may only be used if evidence of no ignition sparking in case of lightning current loading is provided. The pipe clamp of DEHN + SÖHNE is in compliance with the requirement for devoid of ignition sparks at lightning current loading. The clamp has been tested according to EN 50164-1 title English: Lightning Protection Components (LPC) – Part 1: Requirements for connection components in a potentially explosive atmosphere (clamps and connectors), and provided proof of no occurrence of ignition sparks at a lightning current loading of up to 50 kA (10/350 µs). This novel, patented pipe clamp for hazardous areas not only ensures safe electrical contact by means of two contact clips, but also adequate mechanical fixing by an electrically insulated clamping body.

- The Ex pipe clamp provides the following connection possibilities
- Round conductors made of Cu, St/tZn, Al, StSt with Ø8 mm or flexible / stranded copper conductors, cross section 16-35 mm<sup>2</sup>, with E-Cu crimping cable lug (DIN 46235)
  - Flat copper conductors, min. 20 x 2.5 mm, with bore Ø10.5 mm

Environmental requirements related to the corrosion resistance of the materials used for the Ex pipe clamps Ex BRS ... (e.g. CU/galSn, Ms/galSn, StSt, polyamide) have to be taken into account.



Installed at a StSt pipe

  
 DEHN + SÖHNE

### DECLARATION OF MANUFACTURER

<b>Product:</b>	<b>Pipe clamp for explosive zones</b>
<b>Product description:</b>	Part No. 540 821 Part No. 540 801 Part No. 540 803 Part No. 540 805 Part No. 540 810
<b>Manufacturer:</b>	DEHN + SÖHNE GmbH + Co.KG. Hans-Dehn-Str. 1 92318 Neumarkt i.d.OPf., Germany
<b>Application:</b>	The pipe clamp for explosive zones is used for connecting pipes of different materials and diameters to the lightning equipotential bonding structure in explosive atmospheres.  Lightning currents are discharged without formation of sparks as specified in the technical data sheet.  We herewith confirm that the pipe clamp for explosive zones is suitable for the use in explosive zones 1 and 2 (gas, vapour, mist) and explosive zones 21 and 22 (combustible dust) in connection with the installation instructions, Publication No. 1599, "Pipe Clamp for explosive zones" and is tested according to explosion group IIB.  Pipe clamps for explosive zones have no own potential source of ignition (mechanical device) and are thus not subject to the European directive 94/9/EG.  Therefore certification according to the European directive 94/9/EG is <b>not legally admissible</b> and <b>not necessary</b> with respect to explosion protection.

Neumarkt i.d.OPf., 12 Okt. 2009

  
 Dr.-Ing. Ralph Brocke  
 Director R&D

c:\dokume-1\td\l\kale-1\temp\lgp\wiss\herstellereklärung\bandrohrschelle\_ex-bereiche\_upd\_04e\_ausführung\_klein\_und\_groß\_angl\_.doc  
Page 1

**Type EX BRS 27**

Clamping range of Ø6-27 mm (3/4")



Type	EX BRS 27
Part No.	540 821
Lightning impulse current (10/350 µs) Cu Ø6-12 mm (I <sub>imp</sub> )	10 kA
Lightning impulse current (10/350 µs) Cu Ø12-27 mm (3/4") (I <sub>imp</sub> )	20 kA
Lightning impulse current (10/350 µs) Cu Ø27 mm (3/4") (I <sub>imp</sub> )	25 kA
Lightning impulse current (10/350 µs) St/tZn Ø17-27 mm (3/4") (I <sub>imp</sub> )	25 kA
Lightning impulse current (10/350 µs) StSt Ø6-12 mm (I <sub>imp</sub> )	10 kA
Lightning impulse current (10/350 µs) StSt Ø12-27 mm (3/4") (I <sub>imp</sub> )	12 kA
Lightning impulse current (10/350 µs) StSt Ø27 mm (3/4") (I <sub>imp</sub> )	25 kA
Connection	M8
Clamping range pipe Ø	6-27 mm (3/4")
Material of clamping body	polyamide
Material of grip head / tensioning strap	StSt
Material of contact piece	brass/gal Sn
Standard	based on EN 62561-1

**Type EX BRS 90 / 300 / 500**

Type EX BRS 90 Part No. 540 801 clamping range Ø27 (3/4") to 89 mm (3").

Type EX BRS 300 Part No. 540 803 clamping range Ø89 (3") to 300 mm.

Type EX BRS 500 Part No. 540 805 clamping range Ø300 to 500 mm.



Type	EX BRS 90	EX BRS 300	EX BRS 500
Part No.	540 801	540 803	540 805
Lightning impulse current (10/350 µs) Cu (I <sub>imp</sub> )	50 kA	50 kA	—
Lightning impulse current (10/350 µs) St/tZn (I <sub>imp</sub> )	50 kA	50 kA	—
Lightning impulse current (10/350 µs) St/bare (I <sub>imp</sub> )	—	—	50 kA
Lightning impulse current (10/350 µs) StSt (I <sub>imp</sub> )	25 kA	50 kA	50 kA
Connection	M10	M10	M10
Clamping range pipe Ø	27-89 mm (3/4"-3")	89 (3")-300 mm	300-500 mm
Material of clamping body	polyamide	polyamide	polyamide
Material of grip head / tensioning strap	StSt	StSt	StSt
Material of contact piece	Cu/gal Sn	Cu/gal Sn	Cu/gal Sn
Standard	EN 62561-1	EN 62561-1	EN 62561-1

**Separate clamping body**

For use with endless tensioning strap (Part No. 540 901), clamping ranges Ø27 (3/4") to 500 mm.



Type	SCK EX BRS ASSM10 V2A
Part No.	540 810
Lightning impulse current (10/350 µs) Cu (I <sub>imp</sub> )	50 kA
Lightning impulse current (10/350 µs) St/tZn (I <sub>imp</sub> )	50 kA
Lightning impulse current (10/350 µs) StSt (I <sub>imp</sub> )	25 kA
Connection	M10
Clamping range pipe Ø	27 (3/4")-500 mm
Material of clamping body	polyamide
Material of grip head / tensioning strap	StSt
Material of contact piece	Cu/gal Sn
Standard	EN 62561-1

**Accessories for Pipe Clamps for Hazardous Areas Zone 1/21, 2/22**

**Tensioning Strap**



Type	SPB 25X0.3 L100M V2A
Part No.	540 901
Material	StSt
Strap dimension (w x d)	25 x 0.3 mm
Length	100 m



## Voltage Limiting Devices

## Voltage Limiting Device

- Electrical isolation of insulated track sections and earthed parts of installations
- Safe equipotential bonding in case of a short-circuit or earth fault at the overhead contact line due to high-current-resistant welding of the electrodes
- Discharge of lightning surges without short-circuit formation due to lightning-resistant SDS ... voltage limiting device
- Short-circuit withstand capability up to 25 kA<sub>rms</sub> / 100 ms; 36 kA<sub>rms</sub> / 75 ms



EN 50122-1 describes the use of voltage limiting devices for d.c. and a.c. traction systems for so-called "open traction system earthing" of conductive components of the overhead contact line and pantograph zone. Voltage limiting devices (SDS ...) are used to prevent the occurrence of hazardous surges between the insulated tracks or track sections of electric railways and earthed parts of the installation.

Their function is to permanently connect parts of the installation in the overhead contact line and pantograph zone to the return circuit as soon as the threshold voltage is exceeded.

In case of atmospheric overvoltages, the lightning-resistant SDS ... voltage limiting device is capable of returning to its initial state after discharging the impulse current. Only if the specified lightning current load is exceeded, a permanent short-circuit is initiated by high-current-resistant welding of the electrodes and the fuse link has to be replaced.

The SDS voltage limiting device consists of a spark gap unit and the respective connecting kit and can be directly connected to the rail or overhead contact line tower.

The spark gap unit of type SDS 1 (Part No. 923 110) developed by DEHN + SÖHNE has also been approved by the German Federal Railway Authority (EBA).

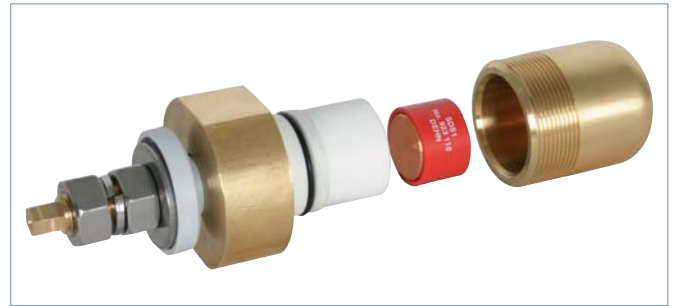

**SDS 1**Voltage limiting device for a power-frequency sparkover voltage  $\leq 950$  V.

Type SDS ...	1
Part No.	923 110
Power frequency sparkover voltage ( $U_{av}$ )	$\leq 950$ V
d.c. sparkover voltage ( $U_{ag}$ )	570 ... 780 V
Impulse sparkover voltage	$\leq 1200$ V (1 kV/ $\mu$ s)
Self-extinguishing capability	300 A / 65 V
Lightning current discharge capacity (10/350 $\mu$ s) 0.1x / 0.5x / 1x	5 kA
Lightning current withstand capability (10/350 $\mu$ s)	25 kA
Safe short-circuit due to welding of the electrodes in case of alternating currents	$\geq 2.5$ kA / 1000 V / 30 ms, $\geq 1.5$ kA / 1000 V / 100 ms
Safe short-circuit due to welding of the electrodes in case of direct currents	$\geq 750$ A / 250 ms
Short-circuit withstand capability	25 kA <sub>rms</sub> / 100 ms; 36 kA <sub>rms</sub> / 75 ms
Long-term current	1 kA <sub>rms</sub> for $t \leq 120$ s
Leakage current ( $I_{lc}$ )	$< 1$ $\mu$ A for 100 V d.c.
Operating temperature range ( $T_U$ )	-40 °C ... +80 °C
To be mounted with	MA SDS M12 mast adapter
Approvals	EBA
DB drawing No.	4 Ebs 15.13.20 Sheet 2

**SDS 2**

Voltage limiting device for a d.c. sparkover voltage of 350 V.



Type SDS ...	2
Part No.	923 117
d.c. sparkover voltage ( $U_{ag}$ )	350 V +/- 20 %
Impulse sparkover voltage	$\leq 900$ V (1 kV/ $\mu$ s)
Lightning current discharge capacity (10/350 $\mu$ s) 0.1x / 0.5x / 1x	2 kA
Lightning current withstand capability (10/350 $\mu$ s)	25 kA
Safe short-circuit due to welding of the electrodes in case of direct currents	$\geq 600$ A / 250 ms
Short-circuit withstand capability	25 kA <sub>rms</sub> / 100 ms; 36 kA <sub>rms</sub> / 75 ms
Long-term current	1 kA <sub>rms</sub> for $t \leq 120$ s
Leakage current ( $I_{lc}$ )	$< 1$ $\mu$ A for 100 V d.c.
Operating temperature range ( $T_U$ )	-40 °C ... +80 °C
To be mounted with	MA SDS M12 mast adapter

**SDS 3**

Voltage limiting device for a d.c. sparkover voltage of 550 V.



Type SDS ...	3
Part No.	923 116
d.c. sparkover voltage ( $U_{ag}$ )	550 V
Impulse sparkover voltage	$\leq 1000$ V (1 kV/ $\mu$ s)
Lightning current discharge capacity (10/350 $\mu$ s) 0.1x / 0.5x / 1x	2.5 kA
Lightning current withstand capability (10/350 $\mu$ s)	25 kA
Short-circuit withstand capability	25 kA <sub>rms</sub> / 100 ms
Operating temperature range ( $T_U$ )	-40 °C ... +80 °C
To be mounted with	MA SDS M12 mast adapter

### SDS 4

Voltage limiting device for a d.c. sparkover voltage of 230 V.

Type SDS ...	4
Part No.	923 118
d.c. sparkover voltage ( $U_{ag}$ )	230 V +/- 20%
Impulse sparkover voltage	≤ 650 V (1 kV/μs)
Lightning current discharge capacity (10/350 μs) 0.1x / 0.5x / 1x	2.5 kA
Lightning current withstand capability (10/350 μs)	25 kA
Impulse current discharge capacity (8/20 μs) 0.1x / 0.5x / 1x	20 kA
Safe short-circuit due to welding of the electrodes in case of direct currents	≥ 600 A / 250 ms
Short-circuit withstand capability	25 kA <sub>rms</sub> / 100 ms; 36 kA <sub>rms</sub> / 75 ms
Long-term current	1 kA <sub>rms</sub> for t ≤ 120 s
Leakage current ( $I_{lc}$ )	< 1 μA for 100 V d.c.
Operating temperature range ( $T_U$ )	-40 °C ... +80 °C
To be mounted with	MA SDS M12 mast adapter



### SDS 5

Voltage limiting device for a d.c. sparkover voltage of 120 V.

Type SDS ...	5
Part No.	923 119
d.c. sparkover voltage ( $U_{ag}$ )	120 V +/- 20 %
Impulse sparkover voltage	≤ 600 V (1 kV/μs)
Lightning current discharge capacity (10/350 μs) 0.1x / 0.5x / 1x	2 kA
Lightning current withstand capability (10/350 μs)	25 kA
Impulse current discharge capacity (8/20 μs) 0.1x / 0.5x / 1x	20 kA
Safe short-circuit due to welding of the electrodes in case of direct currents	≥ 600 A / 250 ms
Short-circuit withstand capability	25 kA <sub>rms</sub> / 100 ms; 36 kA <sub>rms</sub> / 75 ms
Long-term current	1 kA <sub>rms</sub> for t ≤ 120 s
Leakage current ( $I_{lc}$ )	< 1 μA for 100 V d.c.
Operating temperature range ( $T_U$ )	-40 °C ... +80 °C
To be mounted with	MA SDS M12 mast adapter



## Accessories for Voltage Limiting Devices

### Mast Adapter for SDS Voltage Limiting Devices

For installation on the mast profile of overhead contact line masts with Ø8-12 mm.

Type	MA SDS M12
Part No.	723 199
Lightning current carrying capability (10/350 μs)	25 kA
Short-circuit withstand capability	21 kA <sub>rms</sub> / 30 ms
Long-term current	1 kA <sub>rms</sub> at t ≤ 120 s
Leakage current ( $I_{lc}$ )	< 1 μA at 100 V d.c.
Dimensions of the threaded pin	M12
Material	Brass
Degree of protection of the inner enclosure	IP 67



DEHN protects.



## Equipotential Busbars

## Equipotential Busbars K12 with Snap-on Terminals

For protective and functional equipotential bonding according to IEC 60364-4-41/60364-5-54 and lightning equipotential bonding according to IEC 62305-3.

**Standard type** Terminals for: 10 conductors 2.5-95 mm<sup>2</sup> (solid/stranded) or Rd Ø10 mm  
1 conductor Fl up to 30 x 4 mm

Part No.	563 200
Contact bar	Cu/gal Sn
Cross section	30 mm <sup>2</sup>
Standard	EN 62561-1



**UV stabilised type** Terminals for: 10 conductors 2.5-95 mm<sup>2</sup> (solid/stranded) or Rd Ø10 mm  
1 conductor Fl up to 30 x 4 mm

Part No.	563 201
Contact bar	Cu/gal Sn
Cross section	30 mm <sup>2</sup>
Standard	EN 62561-1



## Equipotential Busbar MS

For equipotential bonding. Terminals for: 7 conductors Rd 2.5–16 mm<sup>2</sup> (solid/stranded)  
1 conductor Rd Ø7–10 mm  
1 conductor Fl up to 30 x 3.5 mm or Rd Ø8–10 mm

Part No.	563 050
Contact bar	brass
Cross section	50 mm <sup>2</sup>

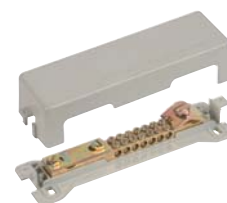

## Equipotential Busbars R15 with Terminal Block System / Kit

For protective and functional equipotential bonding according to IEC 60364-4- 41/60364-5-54 and lightning equipotential bonding according to IEC 62305-3.

**Type A** Terminals for: 7 conductors 2.5-25 mm<sup>2</sup> (solid/stranded)  
2 conductors 16-95 mm<sup>2</sup> (solid/stranded) or Rd Ø8-10 mm  
1 conductor Fl up to 30 x 4 mm

Part No.	563 010
Clamping bar	brass/gal Sn
Cross section	100 mm <sup>2</sup>
Standard	EN 62561-1



**Type B** Terminals for: 5 conductors 2.5-25 mm<sup>2</sup> (solid/stranded)  
3 conductors 16-95 mm<sup>2</sup> (solid/stranded) or Rd Ø8-10 mm  
1 conductor Fl up to 30 x 4 mm

Part No.	563 020
Clamping bar	brass/gal Sn
Cross section	100 mm <sup>2</sup>
Standard	EN 62561-1



**Type C** Terminals for: 13 conductors 2.5-25 mm<sup>2</sup> (solid/stranded)  
1 conductor 16-95 mm<sup>2</sup> (solid/stranded) or Rd Ø8-10 mm

Part No.	563 030
Clamping bar	brass/gal Sn
Cross section	100 mm <sup>2</sup>
Standard	EN 62561-1



**Type D** Terminals for: 7 conductors 2.5-25 mm<sup>2</sup> (solid/stranded)  
2 conductors 16-95 mm<sup>2</sup> (solid/stranded) or Rd Ø8-10 mm  
1 conductor Fl up to 40 x 5 mm

Part No.	563 040
Clamping bar	brass/gal Sn
Cross section	100 mm <sup>2</sup>
Standard	EN 62561-1



Note: You will find our complete earthing / equipotential bonding and lightning protection portfolio in our Lightning Protection Main Catalogue.

### Equipotential Busbar with Terminal Block System Mini

For protective and functional equipotential bonding according to IEC 60364-4-41/60364-5-54 in small systems.

Without cover. Terminals for: 6 conductors 2.5-25 mm<sup>2</sup> (solid/stranded)



Part No.	563 105
Clamping bar	brass/gal Sn
Cross section	100 mm <sup>2</sup>
Standard	EN 50164-1

### Accessories / Construction Kit

#### Terminal Block

For connecting: 1 conductor 2.5-25 mm<sup>2</sup> (solid/stranded)



Part No.	563 011
Material	St/gal Zn
Modules	1

#### Terminal Block

For connecting: 1 conductor 16-95 mm<sup>2</sup> (solid/stranded) or Rd Ø8-10 mm



Part No.	563 013
Material	St/gal Zn
Modules	2

#### Terminal Block

For connecting: 1 conductor Fl up to 30 x 4 mm



Part No.	563 012
Material	St/gal Zn
Modules	4

#### Terminal Block

For connecting: 1 conductor Fl up to 40 x 5 mm



Part No.	563 019
Material	St/gal Zn
Modules	5

#### Clamping bar



Part No.	563 016	563 017	563 018
Material	brass/gal Sn	brass/gal Sn	brass/gal Sn
Length	198 mm	398 mm	798 mm
Modules	15	30	60

#### Bar Frame



Part No.	563 014
Material	plastic
Fixing bores	[2x] 6 x 12 mm
Modules	2

#### Covers

can be snapped on / labelled



Part No.	563 015
Material	plastic
Modules	15

## Equipotential Bonding

### Equipotential Busbars Industry Design

For protective and functional equipotential bonding according to IEC 60364-4-41 410/60364-5-54 and lightning equipotential bonding according to IEC 62305-3, also for use in hazardous areas (screws are secured against self-loosening).

#### 6 terminals

With insulators.

Part No.	472 207	472 209
Material	Cu	StSt
Dimension (l x w x d1)	295 x 40 x 5 mm	295 x 40 x 6 mm
Cross section	200 mm <sup>2</sup>	240 mm <sup>2</sup>
Standard	EN 62561-1	EN 62561-1



#### 8 terminals

With insulators.

Part No.	472 227	472 229
Material	Cu	StSt
Dimension (l x w x d1)	365 x 40 x 5 mm	365 x 40 x 6 mm
Cross section	200 mm <sup>2</sup>	240 mm <sup>2</sup>
Standard	EN 62561-1	EN 62561-1



#### 10 terminals

With insulators.

Part No.	472 217	472 219
Material	Cu	StSt
Dimension (l x w x d1)	435 x 40 x 5 mm	435 x 40 x 6 mm
Cross section	200 mm <sup>2</sup>	240 mm <sup>2</sup>
Standard	EN 62561-1	EN 62561-1



#### 12 terminals

With insulators.

Part No.	472 237	472 239
Material	Cu	StSt
Dimension (l x w x d1)	505 x 40 x 5 mm	505 x 40 x 6 mm
Cross section	200 mm <sup>2</sup>	240 mm <sup>2</sup>
Standard	EN 62561-1	EN 62561-1



## Accessories for Equipotential Busbars

### Covers for EBB Industry Design

With insulators.

Part No.	472 279	472 269	472 289	472 299
Type of EBB	6 terminals	8 terminals	10 terminals	12 terminals
Dimension (l x w x d)	301 x 60 x 0.8 mm	371 x 60 x 0.8 mm	441 x 60 x 0.8 mm	551 x 60 x 0.8 mm
Material	StSt	StSt	StSt	StSt



### Insulator for EBB Industry Design

Part No.	472 210
Material	UP (thermoset)
Terminal thread	M10 (length 12 mm)
Dimension (l x w x d)	32 x 40 mm



### Fixing Kit for EBB Industry Design

Part No.	472 201	472 202
Material of screw	St/tZn	StSt
Screw	45 mm $\nabla$ M10 x 20 mm	45 mm $\nabla$ M10 x 20 mm
Plastic dowel	$\varnothing$ 12 x 60 mm	$\varnothing$ 12 x 60 mm



Note: You will find our complete earthing / equipotential bonding and lightning protection portfolio in our Lightning Protection Main Catalogue.

## Earthing Busbars, single-row

To be screwed to steel constructions, borehole spacing of 35 mm.

## 1x 4 terminals



Part No.	472 309
Material	StSt
Cross section	105 mm <sup>2</sup>
Borehole □	11 x 11 mm

## 1x 6 terminals



Part No.	472 319
Material	StSt
Cross section	105 mm <sup>2</sup>
Borehole □	11 x 11 mm

## 1x 8 terminals



Part No.	472 329
Material	StSt
Cross section	105 mm <sup>2</sup>
Borehole □	11 x 11 mm

## 1x 10 terminals



Part No.	472 339
Material	StSt
Cross section	105 mm <sup>2</sup>
Borehole □	11 x 11 mm

## 1x 12 terminals



Part No.	472 349
Material	StSt
Cross section	105 mm <sup>2</sup>
Borehole □	11 x 11 mm

## Earthing Busbars, two-row

For screwing to steel constructions, borehole spacing of 50 mm.

## 2x 2 terminals



Part No.	472 023	472 109
Material	St/tZn	StSt
Cross section	240 mm <sup>2</sup>	300 mm <sup>2</sup>
Borehole Ø	11 mm	11 mm

## 2x 3 terminals



Part No.	472 022	472 119
Material	St/tZn	StSt
Cross section	240 mm <sup>2</sup>	300 mm <sup>2</sup>
Borehole Ø	11 mm	11 mm

## 2x 4 terminals



Part No.	472 024	472 129
Material	St/tZn	StSt
Cross section	240 mm <sup>2</sup>	300 mm <sup>2</sup>
Borehole Ø	11 mm	11 mm

## 2x 6 terminals



Part No.	472 021	472 139
Material	St/tZn	StSt
Cross section	240 mm <sup>2</sup>	300 mm <sup>2</sup>
Borehole Ø	11 mm	11 mm

Note: You will find our complete earthing / equipotential bonding and lightning protection portfolio in our Lightning Protection Main Catalogue.



## Connecting Clamps

## Connecting Clamps for Reinforcements

To connect the reinforcing steel mesh or reinforcement to round and flat conductors. Arrangement: (II) = parallel (+) = cross

## For T, cross and parallel connections

Part No.	308 025
Material	St/tZn
Clamping range Rd / Rd	(+) 6-10 / 6-10 mm
Clamping range Rd / Fl	(+) 6-10 / 30 mm
Clamping range Fl / Fl	(II) 30 / 30 mm



## For T, cross and parallel connections

Part No.	308 026
Material	St/tZn
Clamping range Rd / Rd	(+) 6-10 / 30 mm
Clamping range Fl / Fl	(+ / II) 30 / 30 mm



## For T and cross connections

Part No.	308 030
Material	St/bare
Clamping range Rd / Fl	(+) 6-22 / 40 mm



## For T, cross and parallel connections with clamping frame

For flexible connection of round conductors or for fixed earthing terminals and concurrent fixing in the formwork.

Part No.	308 035
Material	St/bare
Clamping range Rd / Rd	(+ / II) 6-22 / 6-10 mm
Clamping range Rd / Fl	(+) 6-22 / 40 mm



## Pressure U-clamp

For T, cross and parallel connections.

Part No.	308 031
Material	St/bare
Clamping range Rd / Rd	(+ / II) 6-20 / 6-10 mm
Clamping range Rd / Fl	(+ / II) 6-20 / 30 x 3-4 mm
Clamping range Fl / Fl	(+ / II) 30 x 3-4 / 30 x 3-4 mm



## Pressure U-clamp MAXI

For T, cross and parallel connections.

Part No.	308 036
Material	St/bare
Clamping range Rd / Rd	(+ / II) 20-32 / 6-10 mm
Clamping range Rd / Fl	(+ / II) 20-32 / 40 x 4-5 mm



## U-clamp for large Diameters

Part No.	308 045
Material	St/bare
Clamping range Rd / Rd	(II) 16-48 / 6-10 mm
Clamping range Rd / Fl	(II) 16-48 / 30-40 mm



## U-clamp for large Diameters, with two additional clamping frames

For cross connection of round conductors (6-10 mm) or for fixing and concurrent connection of fixed earthing terminals.

Part No.	308 046
Material	St/bare
Clamping range Rd / Rd	(+ / II) 16-48 / 6-10 mm
Clamping range Rd / Fl	(II) 16-48 / 30-40 mm



## MAXI MV Clamps

For T, cross and parallel connections.

Part No.	308 041	308 040
Material	St/tZn	St/bare
Clamping range Rd / Rd	(+ / II) 8-16 / 15-25 mm	(+ / II) 8-16 / 15-25 mm



Note: You will find our complete earthing / equipotential bonding and lightning protection portfolio in our Lightning Protection Main Catalogue.

## Components for Foundation Earth Electrodes

## Connecting Clamps for Foundation Earth Electrodes

Clamps to connect round and flat conductors in the concrete foundation.  
For T, cross and parallel connections, threading of conductors is not necessary.



Part No.	308 120	308 129
Material	St/tZn	StSt
Clamping range Rd / Fl	(+) 10 / 30 mm	(+) 10 / 30 mm
Clamping range Fl / Fl	(+ / II) 30 / 30 mm	(+ / II) 30 / 30 mm

## Spacers angled and reinforced / straight

For installing earth conductors in the foundation slab. With safety lug to prevent loosening of the conductor.



Part No.	290 001	290 002
Type	angled and reinforced	straight
Material	St/tZn	St/tZn
Support Fl	40 mm	40 mm
Support Rd	8-10 mm	8-10 mm
Length	300 mm	280 mm

## Expansion Strap for Foundation Earth Electrodes

For leading the foundation earth electrode through the expansion joints in case of large foundations (several sections), so that it is not necessary to lead the earth electrode out of the base plate.



Part No.	308 150
Material of strap	StSt
Dimension of strap (l x w x d)	approx. 700 x 30 x (4 x 1) mm
Material of block	polystyrene

## Components for Ring Equipotential Bonding

## Flat Strip / Round Conductor Holder with Thrust Piece

For wall mounting. Thrust piece with screw M8 for the installation of flat strip up to 11 mm and round conductor 6-10 mm.



## Wall distance 11 mm

Part No.	277 230	277 237	277 239
Material of conductor holder	St/tZn	Cu	StSt
Fixing	Ø13 und 7 x 20 mm	Ø13 und 7 x 20 mm	Ø13 und 7 x 20 mm
Material of screw	StSt	StSt	StSt

## Flat Strip / Round Conductor Holder with Thrust Piece

## Wall distance 15 mm



Part No.	277 240
Material of conductor holder	St/tZn
Fixing	7 x 15 mm
Material of screw	StSt

## Terminal Clamp

For universal connection to the ring equipotential bonding of St/tZn, copper or stainless steel (StSt).



Part No.	563 169
Conductor holder support Rd / Fl	Ø8-10 / 30 x 3 up to 11 mm
Material	StSt
Terminal cross section	2.5-95 mm <sup>2</sup>

## Clamping Piece

Clamping piece for the connection of flat material to construction elements or e.g. for the connection of terminal clamps to steel girders (no bore in the flat strip).



Part No.	380 129
Clamping range Fl	up to 30 x 4 mm
Material	StSt
Fixing	square hole 11 x 11 mm

Note: You will find our complete earthing / equipotential bonding and lightning protection portfolio in our Lightning Protection Main Catalogue.

No.	Brochures
DS103E	DEHN protects Wind Turbines
DS104E	DEHN protects Cell Sites
DS109E	DEHN protects Photovoltaic Systems
DS113E	DEHN tests and analyses – DEHN Test Centre
DS144E	DEHN protects Biogas Plants
DS158E	DEHN Concept – Planning of lightning protection systems
DS189D/E	DEHN protects PV systems worldwide
DS197E	DEHN protects Safety Systems
DS214E	DEHN protects Gas Industry Plants
DS240E	Operation and maintenance of PV power plants
DS243E	DEHN protects Smart Power Grids
DS249E	DEHN protects Pipelines – Cathodic Corrosion Protection Solutions
DS250E	Selection Matrix - Lightning Current and Surge Arresters
DS509E	DEHN protects.
DS614E	DEHN stops Surges
DS661E	When Lightning Strikes – What to do during a Thunderstorm
DS702E	Lightning Protection Guide
DS709E	Planning of Lightning Protection Systems – DEHNsupport Toolbox

No.	Brochures for Power Supply Systems
DS187E	DEHNsecure protects Direct Current Applications
DS193E	DEHNshield: Application-optimised Combined Arrester
DS196E	More Space in the Switchgear Cabinet – Arresters with integrated Backup Fuse
DS199E	DEHNshield: Universal solution for electromobility (pdf only)
DS215E	Surge and fire protection – Arresters with SCI Technology for D.C. Circuits
DS218D/E	DEHNcombo YPV SCI (pdf only)
DS224D/E	DEHNcube YPV SCI (pdf only)
DS227D/E	DEHNguard SE H LI (pdf only)
DS228D/E	DEHNcord (pdf only)
DS237D/E	DEHNguard SE DC
DS247D/E	DEHNbloc Maxi CI (pdf only)
DS253E	Surge protection concept for LED street lights (pdf only)
DS641E	Coordinated Surge Protection
DS649E	Red/Line Selection Guide

No.	Brochures for Information Technology Systems
DS137D/E	DEHNgate: Coaxial Arresters
DS143E	BLITZDUCTOR XT: Modular Lightning Current and Surge Arrester
DS145E	DEHNrapid LSA: Modular Lightning and Surge Protection
DS150E	Yellow/Line Selection Guide
DS164E	BLITZDUCTOR XTU: Universal Lightning Current and Surge Arrester (pdf only)
DS174E	Testing and monitoring
DS188E	DEHNpatch / UGKF / DEHNgate (pdf only)
DS248D/E	DEHNvario – Compact DIN rail mounted SPD (pdf only)

No.	Catalogues / Price Lists
DS401E	Lightning Protection / Earthing
DS405E	Safety Equipment

No.	CD / DVD
DS702CD	Lightning Protection Guide on CD
DS708E	Animations on DVD Surge Protection – Power Supply Systems <ul style="list-style-type: none"> <li>• DEHNguard SE DC</li> <li>• DEHNguard SE H LI</li> <li>• DEHNcube protects Photovoltaic Systems</li> <li>• DEHN protects Photovoltaic Systems</li> </ul> Surge Protection – Information Technology Systems <ul style="list-style-type: none"> <li>• DEHN protects Cell Sites</li> <li>• Protection of Ex (i) circuits</li> <li>• Maintenance strategy with BLITZDUCTOR XT</li> <li>• DEHNvario: Lightning and Surge Protection for electroacoustic Systems</li> </ul> Surge Protection – Lightning Equipotential Bonding <ul style="list-style-type: none"> <li>• Pipelines exposed to lightning strikes and overvoltage</li> </ul>

No.	Reprints
SD61E	Surge Protection – Practice-Oriented and Standard-Conform
SD63E	Lightning and Surge Protection for Telecommunications and Signalling Networks
SD78E	Mobile measuring system for lightning current detection
SD86E	Surge protection concept for LED street lights

### DEHNacademy seminars

We hold seminars on

- Lightning Protection / Earthing
- Surge Protection
- Safety Equipment

as well as protection for special applications such as cell sites, photovoltaic systems, wind turbines, etc.

For more detailed information on dates, locations, etc., please contact the responsible DEHN+SÖHNE representative in your country.

### Contact

The printed publications can be ordered free of charge from our **International Sales Department**:

Phone: +49 9181 906 1462  
 Fax: +49 9181 906 1444  
 sales@dehn.de

**DIN VDE standards, VDE-Verlag, Berlin****DIN VDE 0100-100:2009-06**

Low-voltage electrical installations Part 1: Fundamental principles, assessment of general characteristics, definitions (IEC 60364-1:2005, modified);  
German implementation HD 60364-1:2008

**DIN VDE 0100-410:2007-06**

Low-voltage electrical installations – Part 4-41: Protection for safety – Protection against electric shock (IEC 60364-4-41:2005, modified);  
German implementation HD 60364-4-41:2007

**DIN VDE 0100-443:2007-06**

Low-voltage electrical installations – Part 4-44: Protection for safety – Protection against voltage disturbances and electromagnetic disturbances – Clause 443: Protection against overvoltages of atmospheric origin or due to switching (IEC 60364-4-44:2001 + A1:2003, modified);  
German implementation HD 60364-4-443:2006

**DIN VDE 0100-534:2009-02**

Low-voltage electrical installations – Part 5-53: Selection and erection of electrical equipment – Isolation, switching and control – Clause 534: Devices for protection against overvoltages (IEC 60364-5-53:2001/A1:2002 (Clause 534), modified);  
German implementation HD 60364-5-534:2008

**DIN VDE 0100-540:2012-06**

Low-voltage electrical installations – Part 5-54: Selection and erection of electrical equipment – Earthing arrangements, protective conductors and protective bonding conductors (IEC 60364-5-54:2011);  
German implementation HD 60364-5-54:2011

**DIN VDE 0100-717:2010-10**

Low-voltage electrical installations – Part 7-717: Requirements for special installations or locations – Mobile or transportable units (IEC 60364-7-717:2009, modified);  
German implementation HD 60364-7-717:2010

**DIN VDE 0141:2000-01**

Earthing system for special power installations with nominal voltages above 1 kV

**DIN VDE 0618-1:1989-08**

Equipment for equipotential bonding; equipotential bonding bush for main equipotential bonding

**DIN VDE 0800-1:1989-05**

Telecommunications;  
General concepts; requirements and tests for the safety of facilities and apparatus

**DIN V VDE V 0800-2:2011-06**

Information technology  
Equipotential bonding and earthing (additional specifications)

**DIN VDE 0800-10:1991-03**

Telecommunications  
Transitional requirements on erection and operation of installations

**DIN EN 41003**

DIN VDE 0804-100:2009-04  
Particular safety requirements for equipment to be connected to telecommunication networks;  
German version EN 41003:2008

**DIN EN 50178**

DIN VDE 0160:1998-04  
Electronic equipment for use in power installations; German version EN 50178:1997

**DIN EN 50514**

DIN VDE 0805-514:2009-04  
Audio, video and information technology equipment – Routine electrical safety testing in production; German version EN 50514:2008

**DIN EN 60060-1**

DIN VDE 0432-1:2011-10  
High voltage test techniques – Part 1: General specifications and test requirements (IEC 60060-1:2010);  
German version EN 60060-1:2010

**DIN EN 60099-1**

DIN VDE 0675-1:2000-08  
Surge arresters – Part 1: Non-linear resistor type gapped surge arresters for a.c. systems (IEC 60099-1:1991)  
German version EN 60099-1:1994 + A1:1999

**DIN EN 60664-1**

DIN VDE 0110-1:2008-01  
Insulation coordination for equipment within low-voltage systems – Part 1: Principles, requirements and tests (IEC 60664-1:2007)  
German version EN 60664-1:2007

**DIN EN 60728-11**

Cable networks for television signals, sound signals and interactive services – Part 11: Safety (IEC 60728-11:2010);  
German version EN 60728-11:2010

**DIN EN 61643-11**

VDE 0675-6-11:2013-04  
Low-voltage surge protective devices – Part 11: Surge protective devices connected to low-voltage power systems; Requirements and tests (IEC 61643-11:2011, modified);  
German version EN 61643-11:2012

**DIN EN 62305-1**

VDE 0185-305-1:2011-10  
Protection against lightning – Part 1: General principles (IEC 62305-1:2010, modified);  
German version EN 62305-1:2006

**DIN EN 62305-2**

VDE 0185-305-2:2013-02  
Protection against lightning – Part 2: Risk management (IEC 62305-2:2010);  
German version EN 62305-2:2012

**DIN EN 62305-3**

VDE 0185-305-3:2011-10  
Protection against lightning – Part 3: Physical damage to structures and live hazard (IEC 62305-3:2010, modified);  
German version EN 62305-3:2011

**DIN EN 62305-4**

VDE 0185-305-4:2011-10  
Protection against lightning – Part 4: Electrical and electronic systems within structures (IEC 62305-4:2010, modified);  
German version EN 62305-4:2011

**DIN EN 62561-1**

VDE 0185-561-1:2013-02  
Lightning Protection System Components (LPSC) – Part 1: Requirements for connection components (IEC 62561-1:2012, modified);  
German version EN 62561-1:2012

**DIN 18014:2014-03**

Foundation earth electrode – Planning, execution and documentation

**IEC 60664-1:2007-04**

Insulation coordination for equipment within low-voltage systems; part 1: principles, requirements and tests

**IEC 61643-11:2011-03**

Low-voltage surge protective devices – Part 11: Surge protective devices connected to low-voltage power distribution systems – Requirements and testing methods

**IEC 62305-1:2010-12**

Protection against lightning – Part 1: General principles

**IEC 62305-2:2010-12**

Protection against lightning – Part 2: Risk management

**IEC 61643-21:2012-07**

Low voltage surge protective devices – Part 21: Surge protective devices connected to telecommunications and signalling networks; Performance requirements and testing methods

**IEC 62305-3:2010-12**

Protection against lightning; Part 1: General principles

**IEC 62305-4:2010-12**

Protection against lightning; Part 2: Risk management

**IEC 62305-3:2010-12**

Protection against lightning – Part 3: Physical damage to structures and life hazard

**IEC 62305-4:2010-12**

Protection against lightning – Part 4: Electrical and electronic systems within structures

**VG standards, Beuth-Verlag GmbH****VG 95 372:2013-11**

Electromagnetic Compatibility (EMC) including Electromagnetic Pulse (EMP) and Lightning Protection – Survey

**VG 95 371-10:2011-09**

Electromagnetic compatibility (EMC) including electromagnetic pulse (EMP) and lightning protection – Fundamentals – Part 10: Threat levels for NEMP and lightning  
Supplement 1:2005-01,  
Supplement 2:2005-01

**VG 96 907-1:2013-01**

Nuclear Electromagnetic Pulse (NEMP) and lightning protection – Design guidelines and protective devices – Part 1: Fundamentals

**Further standards****DVGW GW 309:2013-09**

Elektrische Überbrückung bei Rohrtrennungen [Electrical bridging of separate pipe sections]  
ZfGW-Verlag GmbH, Frankfurt.

**AfK-Empfehlung Nr. 5:2014-02**

Kathodischer Korrosionsschutz in Verbindung mit explosionsgefährdeten Bereichen [AfK recommendation No. 5:2010-07, Cathodic corrosion protection in connection with potentially explosive atmospheres]  
ZfGW-Verlag GmbH, Frankfurt

**KTA 2206/2009-11:**

Auslegung von Kernkraft - werken gegen Blitzeinwirkung [Protection for nuclear power plants against lightning effects]

**Books**

Hasse P., Wiesinger J., Zischank W.:  
"Handbuch für Blitzschutz und Erdung"  
[Lightning Protection and Earthing Guide]  
Pflaum Verlag GmbH & Co.KG, Munich  
5<sup>th</sup> edition of 2006, ISBN 3-7905-0931-0

Raab V.:  
"Überspannungsschutz in Verbraucheranlagen – Auswahl, Errichtung, Prüfung"  
[Surge protection for consumer's installations – Selection, installation and testing],  
Huss-Medien GmbH Verlag Technik, Berlin  
2<sup>nd</sup> updated and amended edition of 2003  
ISBN 3-341-01347-4

Landers E.U., Zahlmann P.:  
"EMV – Blitzschutz von elektrischen und elektronischen Systemen in baulichen Anlagen – Risiko-Management, Planen und Ausführen nach den neuen Normen der Reihe VDE 0185-305-x (VDE 0185-305-x)"  
3. vollständig überarbeitete Auflage 2013,  
[EMC-based lightning protection for electrical and electronic systems in structures – Risk management, design and installation according to the new standard series DIN VDE 0185-305-x (VDE 0185-305-x),  
3<sup>rd</sup> completely revised edition of 2013],  
VDE series volume No. 185,  
Berlin-Offenbach: VDE Verlag GmbH,  
ISBN 978-3-8007-3399-6

DEHN + SÖHNE GmbH + Co. KG.  
Lightning Protection Guide,  
3<sup>rd</sup> updated edition 2015,  
ISBN 978-3-9813770-1-9

**Notes**

This catalogue replaces the Main Catalogue Surge Protection 2014/2015.

All information provided in this catalogue about the possible use of our products should be regarded as product information and for advisory purposes only. This information is based on experience and is specified to the best of our knowledge. We do not accept any liability in this respect. This particularly applies to the different conditions of use which are beyond our control. We recommend to check whether the respective DEHN product is suitable for the intended application. Application, use and processing of our products are beyond our control. Therefore, the product is completely subject to the user's responsibility.

Illustrations are not binding.

We accept no liability for misprints, modifications and errors.

**\*) GTIN (EAN-Code)**

In this catalogue, you will find the GTIN (EAN code) next to the Part No. For reasons of clarity, only the individual GTIN part is specified. The country and DEHN + SÖHNE code (40 13364) must be put in front of this number.

**Abbreviations**

<b>PG</b>	Product Group
<b>PU</b>	Packing Unit
<b>SU</b>	Sales Unit (Piece, Meter, Set or Pair)
<b>pc(s)</b>	Piece
<b>m</b>	Meter
<b>Sa</b>	Set
<b>Pa</b>	Pair

**Weight** Weight per sales unit

**Sources**

Lightning photos by Michael Bath, [www.lightningphotography.com](http://www.lightningphotography.com)









Part No. / GTIN\* / PG / Weight / PU / SU / Page

Part No.	GTIN*	PG	Weight	PU	SU	Page
910 099	037298	4-2-7	38 g	1	pc(s)	214
910 200	144019	4-6-1	140 g	1	pc(s)	105
910 486	124479	4-5-2	130 g	1	pc(s)	216
910 489	136311	4-6-1	19 g	1	pc(s)	216
910 499	157149	4-5-2	180 g	1	pc(s)	216
910 502	080348	4-6-2	178 g	1	pc(s)	115
910 507	097230	4-6-1	924 g	1	pc(s)	219
910 508	111363	4-6-1	800 g	1	pc(s)	219
910 511	111424	4-6-1	1.32 kg	1	pc(s)	114
910 511	111424	4-6-1	1.32 kg	1	pc(s)	219
910 631	108196	4-1-7	114 g	1	pc(s)	41
910 641	093416	4-1-7	1 g	20	pc(s)	41
910 642	107878	4-1-7	80 g	1	pc(s)	41
910 652	114531	4-6-1	65 g	1	pc(s)	218
910 653	113008	4-6-1	1.06 kg	1	pc(s)	218
910 655	149250	4-6-1	835 g	1	pc(s)	218
910 695	118959	4-6-1	180 g	1	pc(s)	215
910 696	149359	4-6-1	54 g	1	pc(s)	216
910 697	123717	4-2-7	31 g	1	Sa	157
912 253	068360	4-1-3	563 g	1	pc(s)	95
912 254	073685	4-1-7	300 g	1	pc(s)	94
917 900	150676	4-2-1	3 g	5	pc(s)	166
917 920	150560	4-2-2	32 g	1	pc(s)	164
917 921	150577	4-2-2	31 g	1	pc(s)	164
917 922	150584	4-2-2	31 g	1	pc(s)	164
917 940	150591	4-2-2	31 g	1	pc(s)	164
917 941	150607	4-2-2	31 g	1	pc(s)	164
917 942	150614	4-2-2	31 g	1	pc(s)	164
917 960	150638	4-2-2	32 g	1	pc(s)	165
917 970	150621	4-2-2	31 g	1	pc(s)	164
917 976	151529	4-2-7	9 g	1	pc(s)	166
917 977	151536	4-2-7	9 g	1	pc(s)	166
917 987	150645	4-2-3	30 g	1	pc(s)	164
917 988	150652	4-2-3	25 g	1	pc(s)	164
917 989	150669	4-2-3	30 g	1	pc(s)	164
918 400	074231	4-2-2	104 g	1	pc(s)	169
918 401	074224	4-2-2	182 g	1	pc(s)	169
918 407	095335	4-2-2	104 g	1	pc(s)	169
918 408	125292	4-2-2	110 g	1	pc(s)	170
918 409	146709	4-2-2	110 g	1	pc(s)	170
918 410	093126	4-2-2	105 g	1	pc(s)	170
918 411	093133	4-2-2	99 g	1	pc(s)	170
918 420	094895	4-2-2	212 g	1	pc(s)	171
918 421	094901	4-2-2	118 g	1	pc(s)	171
918 422	149267	4-2-2	97 g	1	pc(s)	169
919 010	071612	4-2-8	13 g	10	pc(s)	212
919 011	071605	4-2-8	28 g	10	pc(s)	212
919 012	071599	4-2-8	40 g	1	pc(s)	212
919 013	071582	4-2-8	55 g	1	pc(s)	212
919 014	071575	4-2-8	5 g	10	pc(s)	212
919 015	071568	4-2-8	15 g	1	pc(s)	212
919 016	071551	4-2-8	481 g	1	pc(s)	212
919 030	103504	4-2-8	167 g	1	pc(s)	213
919 031	103511	4-2-8	2 g	20	pc(s)	213
919 032	103528	4-2-8	2 g	20	pc(s)	213
919 033	103535	4-2-8	5 g	20	pc(s)	213
919 034	103542	4-2-8	7 g	10	pc(s)	213
919 035	103559	4-2-8	1 g	10	pc(s)	213
919 036	103566	4-2-8	23 g	25	pc(s)	213
919 037	103573	4-2-8	50 g	20	pc(s)	213
919 038	103580	4-2-8	82 g	10	pc(s)	213
919 880	095090	4-2-7	5 g	25	pc(s)	166

Part No.	GTIN*	PG	Weight	PU	SU	Page
920 211	120570	4-2-1	23 g	1	pc(s)	148
920 220	118331	4-2-1	36 g	1	pc(s)	147
920 222	118355	4-2-1	21 g	1	pc(s)	147
920 224	117785	4-2-1	37 g	1	pc(s)	147
920 225	118379	4-2-1	21 g	1	pc(s)	147
920 226	142121	4-2-1	23 g	1	pc(s)	147
920 240	118348	4-2-1	21 g	1	pc(s)	146
920 242	118362	4-2-1	21 g	1	pc(s)	146
920 243	126732	4-2-1	21 g	1	pc(s)	148
920 244	117792	4-2-1	21 g	1	pc(s)	146
920 245	118386	4-2-1	36 g	1	pc(s)	146
920 247	116078	4-2-1	43 g	1	pc(s)	146
920 249	127845	4-2-1	23 g	1	pc(s)	150
920 270	117549	4-2-1	22 g	1	pc(s)	147
920 271	117556	4-2-1	22 g	1	pc(s)	147
920 280	142138	4-2-1	22 g	1	pc(s)	156
920 288	137363	4-2-1	2 g	1	pc(s)	148
920 289	135840	4-2-1	22 g	1	pc(s)	148
920 300	109179	4-2-1	35 g	1	pc(s)	142
920 301	109186	4-2-1	53 g	1	pc(s)	156
920 308	109209	4-2-1	22 g	1	pc(s)	158
920 309	109193	4-2-1	16 g	1	pc(s)	158
920 310	109124	4-2-1	25 g	1	pc(s)	144
920 314	261396	4-2-1	25 g	1	pc(s)	145
920 320	109032	4-2-1	24 g	1	pc(s)	144
920 322	109049	4-2-1	24 g	1	pc(s)	144
920 324	109056	4-2-1	38 g	1	pc(s)	144
920 325	109063	4-2-1	24 g	1	pc(s)	144
920 326	109070	4-2-1	24 g	1	pc(s)	144
920 327	109087	4-2-1	24 g	1	pc(s)	144
920 336	118539	4-2-1	41 g	1	pc(s)	144
920 340	108967	4-2-1	23 g	1	pc(s)	144
920 342	108974	4-2-1	23 g	1	pc(s)	144
920 344	108981	4-2-1	38 g	1	pc(s)	144
920 345	108998	4-2-1	24 g	1	pc(s)	144
920 346	109001	4-2-1	24 g	1	pc(s)	144
920 347	109018	4-2-1	24 g	1	pc(s)	144
920 349	126404	4-2-1	25 g	1	pc(s)	150
920 350	109131	4-2-1	24 g	1	pc(s)	145
920 354	109148	4-2-1	24 g	1	pc(s)	145
920 362	120587	4-2-1	24 g	1	pc(s)	145
920 364	109155	4-2-1	25 g	1	pc(s)	145
920 370	109117	4-2-1	24 g	1	pc(s)	145
920 371	109094	4-2-1	24 g	1	pc(s)	146
920 375	109100	4-2-1	24 g	1	pc(s)	146
920 381	109025	4-2-1	23 g	1	pc(s)	156
920 383	126725	4-2-2	21 g	1	pc(s)	157
920 384	109162	4-2-1	22 g	1	pc(s)	157
920 388	137370	4-2-1	28 g	1	pc(s)	146
920 389	118447	4-2-1	30 g	1	pc(s)	146
920 394	141810	4-2-7	19 g	1	Sa	158
920 395	118157	4-2-8	12 g	1	Sa	159
920 398	126572	4-2-7	6 g	1	Sa	158
920 538	125285	4-2-2	20 g	1	pc(s)	157
922 200	137332	4-2-1	142 g	1	pc(s)	198
922 210	158214	4-2-1	138 g	1	pc(s)	198
922 400	137349	4-2-1	220 g	1	pc(s)	198
923 019	033177	4-4-3	1.7 kg	1	pc(s)	223
923 021	036161	4-4-2	185 g	1	pc(s)	222
923 023	074262	4-4-2	185 g	1	pc(s)	222
923 025	110397	4-5-2	137 g	1	pc(s)	225
923 035	110403	4-5-2	163 g	1	pc(s)	225
923 045	110410	4-5-2	190 g	1	pc(s)	225
923 060	038899	4-4-3	725 g	1	pc(s)	223

Part No.	GTIN*	PG	Weight	PU	SU	Page
923 061	038905	4-4-3	750 g	1	pc(s)	223
923 062	038912	4-4-3	733 g	1	pc(s)	223
923 099	274686	4-5-2	46 g	1	pc(s)	228
923 100	108325	4-4-3	289 g	1	pc(s)	224
923 101	108332	4-4-3	1.98 kg	1	pc(s)	224
923 110	092426	5-7-4	40 g	10	pc(s)	232
923 116	085978	5-7-4	42 g	10	pc(s)	232
923 117	093478	5-7-4	42 g	10	pc(s)	232
923 118	104969	5-7-4	38 g	10	pc(s)	233
923 119	104976	5-7-4	38 g	10	pc(s)	233
923 211	150904	4-5-2	106 g	1	pc(s)	225
923 214	150911	4-5-2	107 g	1	pc(s)	225
923 218	150928	4-5-2	98 g	1	pc(s)	225
923 222	150935	4-5-2	98 g	1	pc(s)	225
923 226	150942	4-5-2	91 g	1	pc(s)	225
923 230	150959	4-5-2	180 g	1	pc(s)	225
923 233	150966	4-5-2	174 g	1	pc(s)	225
923 236	150973	4-5-2	170 g	1	pc(s)	225
923 239	150980	4-5-2	162 g	1	pc(s)	225
923 242	150997	4-5-2	158 g	1	pc(s)	225
923 311	150775	4-5-2	105 g	1	pc(s)	225
923 314	150782	4-5-2	106 g	1	pc(s)	225
923 318	150799	4-5-2	100 g	1	pc(s)	225
923 322	150805	4-5-2	96 g	1	pc(s)	225
923 326	150812	4-5-2	91 g	1	pc(s)	225
923 330	150829	4-5-2	178 g	1	pc(s)	225
923 333	150836	4-5-2	172 g	1	pc(s)	225
923 336	150843	4-5-2	168 g	1	pc(s)	225
923 339	150850	4-5-2	162 g	1	pc(s)	225
923 342	150867	4-5-2	158 g	1	pc(s)	225
923 348	150874	4-5-2	141 g	1	pc(s)	225
923 356	150881	4-5-2	262 g	1	pc(s)	225
923 362	150898	4-5-2	244 g	1	pc(s)	225
923 401	237766	4-9-3	12.16 kg	1	pc(s)	228
924 017	045934	4-2-4	30 g	1	pc(s)	207
924 018	048942	4-2-4	53 g	1	pc(s)	208
924 019	058590	4-2-4	33 g	1	pc(s)	208
924 046	058774	4-2-4	151 g	1	pc(s)	208
924 051	033986	4-2-4	147 g	1	pc(s)	208
924 061	034006	4-2-4	141 g	1	pc(s)	208
924 328	100008	4-1-3	15 g	1	pc(s)	97
924 329	099234	4-1-3	12 g	1	pc(s)	97
924 335	071773	4-1-3	123 g	1	pc(s)	98
924 336	071681	4-1-3	13 g	1	pc(s)	98
924 337	071766	4-1-3	122 g	1	pc(s)	98
924 338	071674	4-1-3	13 g	1	pc(s)	98
924 350	076709	4-1-3	34 g	1	pc(s)	99
924 370	081321	4-1-3	71 g	1	pc(s)	97
924 389	073692	4-1-3	36 g	1	pc(s)	101
924 395	076334	4-1-3	67 g	1	pc(s)	101
924 396	091016	4-1-3	32 g	1	pc(s)	101
925 001	047365	4-2-2	10 g	1	pc(s)	196
926 220	127012	4-2-2	21 g	1	pc(s)	153
926 222	127029	4-2-2	21 g	1	pc(s)	153
926 224	127036	4-2-2	21 g	1	pc(s)	153
926 225	127043	4-2-2	21 g	1	pc(s)	153
926 226	127050	4-2-2	21 g	1	pc(s)	153
926 227	127067	4-2-2	21 g	1	pc(s)	153
926 240	127074	4-2-2	21 g	1	pc(s)	153
926 242	127081	4-2-2	21 g	1	pc(s)	153
926 244	127098	4-2-2	21 g	1	pc(s)	153
926 245	127104	4-2-2	21 g	1	pc(s)	153
926 246	127111	4-2-2	21 g	1	pc(s)	153

Part No.	GTIN*	PG	Weight	PU	SU	Page
926 247	127128	4-2-2	21 g	1	pc(s)	153
926 270	127135	4-2-2	21 g	1	pc(s)	154
926 271	127142	4-2-2	21 g	1	pc(s)	154
926 275	129351	4-2-2	21 g	1	pc(s)	154
926 304	157125	4-2-2	45 g	1	pc(s)	142
926 320	127159	4-2-2	22 g	1	pc(s)	152
926 322	127166	4-2-2	22 g	1	pc(s)	152
926 324	127173	4-2-2	21 g	1	pc(s)	152
926 325	127180	4-2-2	22 g	1	pc(s)	152
926 326	127197	4-2-2	22 g	1	pc(s)	152
926 327	127203	4-2-2	22 g	1	pc(s)	152
926 340	127210	4-2-2	22 g	1	pc(s)	152
926 342	127227	4-2-2	22 g	1	pc(s)	152
926 344	127234	4-2-2	22 g	1	pc(s)	152
926 345	127241	4-2-2	22 g	1	pc(s)	152
926 346	127258	4-2-2	22 g	1	pc(s)	152
926 347	127265	4-2-2	21 g	1	pc(s)	152
926 370	127272	4-2-2	22 g	1	pc(s)	152
926 371	127289	4-2-2	22 g	1	pc(s)	153
926 375	129382	4-2-2	22 g	1	pc(s)	153
928 430	261389	4-2-2	110 g	1	pc(s)	167
929 010	039940	4-2-4	68 g	1	pc(s)	202
929 024	093355	4-2-4	113 g	1	pc(s)	199
929 026	082519	4-2-4	217 g	1	pc(s)	200
929 028	093379	4-2-3	101 g	1	pc(s)	200
929 034	072145	4-2-7	2.36 kg	1	pc(s)	192
929 035	072619	4-2-2	270 g	1	pc(s)	191
929 036	074514	4-2-2	268 g	1	pc(s)	191
929 037	090637	4-2-2	270 g	1	pc(s)	191
929 039	135185	4-2-4	92 g	1	pc(s)	204
929 040	080294	4-2-4	21 g	1	pc(s)	204
929 042	091030	4-2-4	39 g	1	pc(s)	204
929 043	091047	4-2-4	90 g	1	pc(s)	205
929 044	091054	4-2-4	86 g	1	pc(s)	204
929 045	091061	4-2-4	266 g	1	pc(s)	205
929 047	091085	4-2-4	467 g	1	pc(s)	205
929 059	118966	4-2-4	99 g	1	pc(s)	205
929 071	082823	4-2-2	240 g	1	pc(s)	192
929 072	083165	4-2-2	257 g	1	pc(s)	192
929 075	107755	4-2-2	250 g	1	pc(s)	192
929 081	095069	4-2-4	67 g	1	pc(s)	200
929 095	113398	4-2-7	90 g	1	pc(s)	206
929 096	107212	4-2-7	203 g	1	pc(s)	206
929 100	102170	4-2-4	244 g	1	pc(s)	190
929 121	118935	4-2-4	123 g	1	pc(s)	190
929 126	242258	4-2-4	96 g	1	pc(s)	190
929 146	157156	4-2-4	471 g	1	pc(s)	205
929 148	157163	4-2-4	448 g	1	pc(s)	205
929 199	103313	4-2-7	350 g	1	pc(s)	190
929 230	130852	4-2-2	89 g	1	pc(s)	192
929 234	130838	4-2-7	744 g	1	pc(s)	192
929 335	228672	4-2-4	1.38 kg	1	pc(s)	190
929 497	104143	4-2-4	2 g	1	pc(s)	206
929 498	104136	4-2-4	2 g	1	pc(s)	206
929 499	104129	4-2-4	2 g	1	pc(s)	206
929 921	098169	4-2-1	218 g	1	pc(s)	185
929 941	098152	4-2-1	173 g	1	pc(s)	184
929 950	137387	4-2-1	222 g	1	pc(s)	186
929 951	137394	4-2-1	222 g	1	pc(s)	186
929 952	137400	4-2-1	222 g	1	pc(s)	186
929 953	137417	4-2-1	222 g	1	pc(s)	186
929 960	098145	4-2-1	172 g	1	pc(s)	185
929 961	101784	4-2-1	169 g	1	pc(s)	185
929 962	101791	4-2-1	169 g	1	pc(s)	185

**Part No. / GTIN\* / PG / Weight / PU / SU / Page**

Part No.	GTIN*	PG	Weight	PU	SU	Page
929 963	101807	4-2-1	172 g	1	pc(s)	185
929 964	101814	4-2-1	169 g	1	pc(s)	185
929 969	127418	4-2-1	255 g	1	pc(s)	186
929 970	127425	4-2-1	248 g	1	pc(s)	186
929 971	120761	4-2-1	272 g	1	pc(s)	186
929 982	098695	4-2-7	36 g	1	pc(s)	187
929 984	098688	4-2-7	30 g	1	pc(s)	187
929 996	098244	4-2-7	13 g	1	pc(s)	187
941 110	137899	4-1-1	275 g	1	pc(s)	27
941 200	138209	4-1-1	250 g	1	pc(s)	27
941 300	133556	4-1-1	386 g	1	pc(s)	26
941 305	275317	4-1-1	389 g	1	pc(s)	26
941 310	131798	4-1-1	480 g	1	pc(s)	26
941 315	275324	4-1-1	485 g	1	pc(s)	27
941 400	133563	4-1-1	525 g	1	pc(s)	26
941 405	275331	4-1-1	530 g	1	pc(s)	26
950 102	105621	4-1-2	184 g	1	pc(s)	86
950 112	105638	4-1-2	196 g	1	pc(s)	86
950 530	152960	4-1-2	300 g	1	pc(s)	75
950 531	152953	4-1-2	275 g	1	pc(s)	75
950 535	154988	4-1-2	310 g	1	pc(s)	75
950 536	154995	4-1-2	285 g	1	pc(s)	75
951 001	108066	4-1-1	192 g	1	pc(s)	22
951 050	108073	4-1-1	171 g	1	pc(s)	22
951 100	108080	4-1-1	171 g	1	pc(s)	22
951 110	108110	4-1-1	659 g	1	pc(s)	22
951 115	108127	4-1-1	664 g	1	pc(s)	22
951 200	108097	4-1-1	724 g	1	pc(s)	21
951 205	108103	4-1-1	669 g	1	pc(s)	21
951 300	108134	4-1-1	970 g	1	pc(s)	21
951 305	108141	4-1-1	962 g	1	pc(s)	21
951 310	108172	4-1-1	1.27 kg	1	pc(s)	21
951 315	108189	4-1-1	1.28 kg	1	pc(s)	21
951 400	108158	4-1-1	1.35 kg	1	pc(s)	21
951 405	108165	4-1-1	1.36 kg	1	pc(s)	21
952 010	108356	4-1-2	43 g	1	pc(s)	84
952 011	109773	4-1-2	32 g	1	pc(s)	84
952 012	109780	4-1-2	35 g	1	pc(s)	84
952 013	109797	4-1-2	46 g	1	pc(s)	84
952 014	108363	4-1-2	50 g	1	pc(s)	84
952 015	109803	4-1-2	53 g	1	pc(s)	84
952 016	109810	4-1-2	64 g	1	pc(s)	84
952 017	113329	4-1-2	63 g	1	pc(s)	84
952 018	119482	4-1-2	37 g	1	pc(s)	84
952 020	127784	4-1-2	52 g	1	pc(s)	84
952 025	127357	4-1-2	34 g	1	pc(s)	84
952 027	127364	4-1-2	40 g	1	pc(s)	84
952 029	127371	4-1-2	44 g	1	pc(s)	84
952 030	108530	4-1-2	111 g	1	pc(s)	66
952 035	108547	4-1-2	114 g	1	pc(s)	66
952 041	141841	4-1-2	53 g	1	pc(s)	85
952 043	141834	4-1-2	42 g	1	pc(s)	85
952 044	141858	4-1-2	62 g	1	pc(s)	85
952 045	141827	4-1-2	33 g	1	pc(s)	85
952 050	108370	4-1-2	38 g	1	pc(s)	84
952 051	126442	4-1-2	49 g	1	pc(s)	85
952 053	127647	4-1-2	42 g	1	pc(s)	85
952 054	127975	4-1-2	52 g	1	pc(s)	85
952 055	136700	4-1-2	36 g	1	pc(s)	85
952 056	149106	4-1-2	71 g	1	pc(s)	85
952 060	108387	4-1-2	37 g	1	pc(s)	84
952 070	108493	4-1-2	130 g	1	pc(s)	59

Part No.	GTIN*	PG	Weight	PU	SU	Page
952 071	109834	4-1-2	107 g	1	pc(s)	59
952 072	109858	4-1-2	109 g	1	pc(s)	59
952 073	109872	4-1-2	119 g	1	pc(s)	59
952 074	108516	4-1-2	123 g	1	pc(s)	59
952 075	109896	4-1-2	142 g	1	pc(s)	59
952 076	109919	4-1-2	136 g	1	pc(s)	59
952 077	119680	4-1-2	137 g	1	pc(s)	60
952 078	119468	4-1-2	109 g	1	pc(s)	59
952 079	128446	4-1-2	141 g	1	pc(s)	54
952 080	127296	4-1-2	107 g	1	pc(s)	62
952 082	127319	4-1-2	113 g	1	pc(s)	62
952 084	127333	4-1-2	117 g	1	pc(s)	62
952 085	127302	4-1-2	111 g	1	pc(s)	62
952 087	127326	4-1-2	116 g	1	pc(s)	62
952 089	127340	4-1-2	121 g	1	pc(s)	62
952 090	108509	4-1-2	137 g	1	pc(s)	60
952 091	109841	4-1-2	110 g	1	pc(s)	60
952 092	109865	4-1-2	113 g	1	pc(s)	60
952 093	109889	4-1-2	137 g	1	pc(s)	60
952 094	108523	4-1-2	140 g	1	pc(s)	60
952 095	109902	4-1-2	140 g	1	pc(s)	60
952 096	109926	4-1-2	160 g	1	pc(s)	60
952 097	119697	4-1-2	140 g	1	pc(s)	60
952 098	119475	4-1-2	123 g	1	pc(s)	60
952 099	128453	4-1-2	144 g	1	pc(s)	54
952 110	108417	4-1-2	242 g	1	pc(s)	57
952 111	119420	4-1-2	232 g	1	pc(s)	57
952 115	108424	4-1-2	228 g	1	pc(s)	57
952 116	119413	4-1-2	236 g	1	pc(s)	57
952 130	128521	4-1-2	247 g	1	pc(s)	57
952 135	128538	4-1-2	253 g	1	pc(s)	57
952 171	128422	4-1-2	254 g	1	pc(s)	54
952 173	128408	4-1-2	257 g	1	pc(s)	53
952 176	128439	4-1-2	260 g	1	pc(s)	54
952 178	128415	4-1-2	264 g	1	pc(s)	53
952 200	108394	4-1-2	229 g	1	pc(s)	57
952 201	123915	4-1-2	211 g	1	pc(s)	57
952 205	108400	4-1-2	232 g	1	pc(s)	57
952 206	123922	4-1-2	217 g	1	pc(s)	57
952 300	108431	4-1-2	334 g	1	pc(s)	56
952 302	113305	4-1-2	386 g	1	pc(s)	58
952 303	120709	4-1-2	355 g	1	pc(s)	56
952 304	128361	4-1-2	376 g	1	pc(s)	53
952 305	108448	4-1-2	328 g	1	pc(s)	56
952 307	113312	4-1-2	389 g	1	pc(s)	58
952 308	120716	4-1-2	362 g	1	pc(s)	56
952 309	128378	4-1-2	382 g	1	pc(s)	53
952 310	108479	4-1-2	405 g	1	pc(s)	56
952 311	119390	4-1-2	432 g	1	pc(s)	56
952 313	123939	4-1-2	299 g	1	pc(s)	56
952 314	124028	4-1-2	342 g	1	pc(s)	56
952 315	108486	4-1-2	415 g	1	pc(s)	57
952 316	119406	4-1-2	436 g	1	pc(s)	57
952 318	124011	4-1-2	306 g	1	pc(s)	56
952 319	124035	4-1-2	350 g	1	pc(s)	56
952 320	126794	4-1-2	416 g	1	pc(s)	56
952 322	128385	4-1-2	456 g	1	pc(s)	53
952 323	133235	4-1-2	381 g	1	pc(s)	56
952 325	126800	4-1-2	425 g	1	pc(s)	57
952 327	128392	4-1-2	475 g	1	pc(s)	53
952 328	133242	4-1-2	390 g	1	pc(s)	57
952 400	108455	4-1-2	443 g	1	pc(s)	56
952 401	128347	4-1-2	475 g	1	pc(s)	53
952 403	128569	4-1-2	417 g	1	pc(s)	56
952 404	128545	4-1-2	474 g	1	pc(s)	56
952 405	108462	4-1-2	453 g	1	pc(s)	56

Part No.	GTIN*	PG	Weight	PU	SU	Page
952 406	128354	4-1-2	473 g	1	pc(s)	53
952 408	128576	4-1-2	423 g	1	pc(s)	56
952 409	128552	4-1-2	482 g	1	pc(s)	56
952 510	126428	4-1-2	340 g	1	pc(s)	70
952 511	127494	4-1-2	291 g	1	pc(s)	70
952 512	127951	4-1-2	336 g	1	pc(s)	70
952 513	136663	4-1-2	269 g	1	pc(s)	70
952 514	224964	4-1-2	499 g	1	pc(s)	71
952 515	126435	4-1-2	323 g	1	pc(s)	70
952 516	127500	4-1-2	298 g	1	pc(s)	70
952 517	127968	4-1-2	338 g	1	pc(s)	70
952 518	136670	4-1-2	276 g	1	pc(s)	70
952 519	224971	4-1-2	509 g	1	pc(s)	71
952 520	149069	4-1-2	501 g	1	pc(s)	73
952 525	149076	4-1-2	521 g	1	pc(s)	73
952 550	136502	4-1-2	200 g	1	pc(s)	70
952 551	136687	4-1-2	182 g	1	pc(s)	70
952 555	136519	4-1-2	203 g	1	pc(s)	70
952 556	136694	4-1-2	187 g	1	pc(s)	70
952 561	149083	4-1-2	333 g	1	pc(s)	73
952 566	149090	4-1-2	341 g	1	pc(s)	73
952 589	132306	4-5-2	17 g	4	pc(s)	106
952 610	149816	4-1-2	18 g	72	pc(s)	81
952 614	149847	4-1-2	18 g	72	pc(s)	81
952 641	146334	4-1-2	18 g	72	pc(s)	81
952 643	150737	4-1-2	18 g	72	pc(s)	81
952 644	149892	4-1-2	18 g	72	pc(s)	81
952 650	149823	4-1-2	18 g	72	pc(s)	82
952 651	146310	4-1-2	18 g	72	pc(s)	81
952 653	150713	4-1-2	18 g	72	pc(s)	81
952 654	149878	4-1-2	18 g	72	pc(s)	81
952 699	127906	4-5-2	103 g	1	pc(s)	106
952 710	149830	4-1-2	18 g	72	pc(s)	82
952 714	149854	4-1-2	18 g	72	pc(s)	82
952 741	146341	4-1-2	18 g	72	pc(s)	81
952 743	150744	4-1-2	18 g	72	pc(s)	81
952 744	149908	4-1-2	18 g	72	pc(s)	81
952 750	149861	4-1-2	18 g	72	pc(s)	82
952 751	146327	4-1-2	18 g	72	pc(s)	81
952 753	150720	4-1-2	18 g	72	pc(s)	81
952 754	149885	4-1-2	18 g	72	pc(s)	81
952 900	158801	4-1-2	80 g	1	pc(s)	85
952 903	158818	4-1-2	75 g	1	pc(s)	85
952 904	158825	4-1-2	80 g	1	pc(s)	85
952 905	158832	4-1-2	87 g	1	pc(s)	85
952 907	158856	4-1-2	112 g	1	pc(s)	85
952 908	264526	4-1-2	112 g	1	pc(s)	85
952 910	266865	4-1-2	18 g	72	pc(s)	82
952 930	158559	4-1-2	171 g	1	pc(s)	64
952 933	158566	4-1-2	170 g	1	pc(s)	64
952 934	158573	4-1-2	175 g	1	pc(s)	64
952 935	158580	4-1-2	181 g	1	pc(s)	64
952 937	158603	4-1-2	207 g	1	pc(s)	64
952 938	264014	4-1-2	207 g	1	pc(s)	64
952 941	228177	4-1-2	18 g	72	pc(s)	82
952 951	228184	4-1-2	18 g	72	pc(s)	82
953 010	108295	4-1-3	28 g	1	pc(s)	93
953 011	109636	4-1-3	27 g	1	pc(s)	93
953 012	109643	4-1-3	27 g	1	pc(s)	93
953 013	109650	4-1-3	25 g	1	pc(s)	93
953 014	109667	4-1-3	26 g	1	pc(s)	93
953 020	117440	4-1-3	49 g	1	pc(s)	93
953 200	108301	4-1-3	81 g	1	pc(s)	91
953 201	109674	4-1-3	80 g	1	pc(s)	91
953 202	109681	4-1-3	81 g	1	pc(s)	91

Part No.	GTIN*	PG	Weight	PU	SU	Page
953 203	109698	4-1-3	79 g	1	pc(s)	91
953 204	109704	4-1-3	79 g	1	pc(s)	91
953 205	108318	4-1-3	102 g	1	pc(s)	91
953 206	109711	4-1-3	84 g	1	pc(s)	91
953 207	109728	4-1-3	85 g	1	pc(s)	91
953 208	109735	4-1-3	83 g	1	pc(s)	91
953 209	109742	4-1-3	82 g	1	pc(s)	91
953 400	117440	4-1-3	49 g	1	pc(s)	92
953 405	115774	4-1-3	150 g	1	pc(s)	92
961 001	118584	4-1-1	173 g	1	pc(s)	33
961 002	118591	4-1-1	195 g	1	pc(s)	33
961 003	118607	4-1-1	180 g	1	pc(s)	33
961 010	118744	4-1-1	170 g	1	pc(s)	49
961 020	118706	4-1-1	139 g	1	pc(s)	49
961 022	118669	4-1-1	195 g	1	pc(s)	46
961 101	118676	4-1-1	315 g	1	pc(s)	48
961 102	118690	4-1-1	284 g	1	pc(s)	48
961 105	118683	4-1-1	320 g	1	pc(s)	48
961 110	118560	4-1-1	317 g	1	pc(s)	33
961 115	118577	4-1-1	321 g	1	pc(s)	33
961 120	118614	4-1-1	340 g	1	pc(s)	33
961 122	118652	4-1-1	358 g	1	pc(s)	46
961 125	118621	4-1-1	343 g	1	pc(s)	33
961 130	118638	4-1-1	325 g	1	pc(s)	33
961 135	118645	4-1-1	330 g	1	pc(s)	33
961 140	116269	4-1-1	546 g	1	pc(s)	38
961 145	116276	4-1-1	522 g	1	pc(s)	38
961 146	250062	4-1-1	946 g	1	pc(s)	36
961 160	116290	4-1-1	369 g	1	pc(s)	48
961 165	116306	4-1-1	372 g	1	pc(s)	48
961 175	116283	4-1-1	508 g	1	pc(s)	38
961 176	250123	4-1-1	908 g	1	pc(s)	36
961 180	157323	4-1-1	370 g	1	pc(s)	48
961 185	157330	4-1-1	370 g	1	pc(s)	48
961 200	145108	4-1-1	432 g	1	pc(s)	24
961 205	145115	4-1-1	435 g	1	pc(s)	24
971 001	138605	4-1-1	139 g	1	pc(s)	44
971 002	133655	4-1-1	106 g	1	pc(s)	44
971 003	144491	4-1-1	109 g	1	pc(s)	44
971 010	138636	4-1-1	171 g	1	pc(s)	44
971 120	133631	4-1-1	252 g	1	pc(s)	43
971 121	138582	4-1-1	284 g	1	pc(s)	43
971 122	144477	4-1-1	258 g	1	pc(s)	43
971 125	133648	4-1-1	226 g	1	pc(s)	43
971 126	138599	4-1-1	288 g	1	pc(s)	43
971 127	144484	4-1-1	254 g	1	pc(s)	43
971 221	138612	4-1-1	608 g	1	pc(s)	43
971 226	138629	4-1-1	614 g	1	pc(s)	43
972 010	158672	4-1-2	48 g	1	pc(s)	85
972 020	158702	4-1-2	57 g	1	pc(s)	85
972 030	158719	4-1-2	71 g	1	pc(s)	85
972 040	158764	4-1-2	77 g	1	pc(s)	85
972 110	158504	4-1-2	138 g	1	pc(s)	68
972 115	158511	4-1-2	142 g	1	pc(s)	68
972 120	158528	4-1-2	148 g	1	pc(s)	68
972 125	158610	4-1-2	152 g	1	pc(s)	68
972 130	158627	4-1-2	162 g	1	pc(s)	68
972 135	158634	4-1-2	167 g	1	pc(s)	68
972 140	158641	4-1-2	168 g	1	pc(s)	68
972 145	158658	4-1-2	172 g	1	pc(s)	68
989 408	120396	4-2-1	1 kg	1	pc(s)	158
999 990	153776	4-1-1	5 kg	1	pc(s)	226

Type	Part No.	Page	Type	Part No.	Page	Type	Part No.	Page	Type	Part No.	Page
AB EXFS IF1 W 11	923 311	225	BSP M2 BE 5	926 220	153	BXT ML4 BD 5	920 340	144	DCOR L 2P 320	900 432	65
AB EXFS IF1 W 14	923 314	225	BSP M2 BE 60	926 226	153	BXT ML4 BD 60	920 346	144	DCU YPV SCI 1000 1M	900 910	77
AB EXFS IF1 W 18	923 318	225	BSP M2 BE HF 5	926 270	154	BXT ML4 BD EX 24	920 381	156	DCU YPV SCI 1000 2M	900 920	77
AB EXFS IF1 W 22	923 322	225	BSP M4 BD 12	926 342	152	BXT ML4 BD HF 24	920 375	146	DFA 255	924 389	101
AB EXFS IF1 W 26	923 326	225	BSP M4 BD 180	926 347	152	BXT ML4 BD HF 5	920 371	146	DFA D 255	924 395	101
AB EXFS IF1 W 30	923 330	225	BSP M4 BD 24	926 344	152	BXT ML4 BE 12	920 322	144	DFA M 255	924 396	101
AB EXFS IF1 W 33	923 333	225	BSP M4 BD 48	926 345	152	BXT ML4 BE 180	920 327	144	DG 1000	950 102	86
AB EXFS IF1 W 36	923 336	225	BSP M4 BD 5	926 340	152	BXT ML4 BE 24	920 324	144	DG 1000 FM	950 112	86
AB EXFS IF1 W 39	923 339	225	BSP M4 BD 60	926 346	152	BXT ML4 BE 36	920 336	144	DG M PV2 SCI 1000	952 514	71
AB EXFS IF1 W 42	923 342	225	BSP M4 BD HF 24	926 375	153	BXT ML4 BE 48	920 325	144	DG M PV2 SCI 1000 FM	952 519	71
AB EXFS IF1 W 48	923 348	225	BSP M4 BD HF 5	926 371	153	BXT ML4 BE 5	920 320	144	DG M TN 150	952 201	57
AB EXFS IF1 W 56	923 356	225	BSP M4 BE 12	926 322	152	BXT ML4 BE 60	920 326	144	DG M TN 150 FM	952 206	57
AB EXFS IF1 W 62	923 362	225	BSP M4 BE 180	926 327	152	BXT ML4 BE C 12	920 362	145	DG M TN 275	952 200	57
AB EXFS IF3 G 11	923 211	225	BSP M4 BE 24	926 324	152	BXT ML4 BE C 24	920 364	145	DG M TN 275 FM	952 205	57
AB EXFS IF3 G 14	923 214	225	BSP M4 BE 48	926 325	152	BXT ML4 BE HF 5	920 370	145	DG M TN CI 275	952 173	53
AB EXFS IF3 G 18	923 218	225	BSP M4 BE 5	926 320	152	BXT ML4 BPD 24	920 314	145	DG M TN CI 275 FM	952 178	53
AB EXFS IF3 G 22	923 222	225	BSP M4 BE 60	926 326	152	BXT ML4 MY 110	920 388	146	DG M TNC 150	952 313	56
AB EXFS IF3 G 26	923 226	225	BSP M4 BE HF 5	926 370	152	BXT ML4 MY 250	920 389	146	DG M TNC 150 FM	952 318	56
AB EXFS IF3 G 30	923 230	225	BT 24	925 001	196	BXTU ML2 BD S 0-180	920 249	150	DG M TNC 275	952 300	56
AB EXFS IF3 G 33	923 233	225	BVK 16.48 6.10 FL40 BSB STBL			BXTU ML4 BD 0-180	920 349	150	DG M TNC 275 FM	952 305	56
AB EXFS IF3 G 36	923 236	225		308 045	239				DG M TNC 385	952 314	56
AB EXFS IF3 G 39	923 239	225	BVK 16.48 FL40 KB6.10 BSB STBL			DB 1 255 H	900 222	46	DG M TNC 385 FM	952 319	56
AB EXFS IF3 G 42	923 242	225		308 046	239	DB 3 255 H	900 120	46	DG M TNC 440	952 303	56
AD PAS 10AP V2A	472 289	235	BVT ALD 36	918 408	170	DB 700X30X4 V2A	308 150	240	DG M TNC 440 FM	952 308	56
AD PAS 12AP V2A	472 299	237	BVT ALD 60	918 409	170	DB M 1 150	961 110	33	DG M TNC CI 275	952 304	53
AD PAS 6AP V2A	472 279	237	BVT AVD 24	918 422	169	DB M 1 150 FM	961 115	33	DG M TNC CI 275 FM	952 309	53
AD PAS 8AP V2A	472 269	237	BVT ISDN	918 410	170	DB M 1 255	961 120	33	DG M TNS 150	952 403	56
AH FE RF	290 002	240	BVT KKS ALD 75	918 420	171	DB M 1 255 FM	961 125	33	DG M TNS 150 FM	952 408	56
AH FE RF V G	290 001	240	BVT KKS APD 36	918 421	171	DB M 1 320	961 130	33	DG M TNS 275	952 400	56
AH PAS RK	563 015	232	BVT MTTY 24	918 407	169	DB M 1 320 FM	961 135	33	DG M TNS 275 FM	952 405	56
AK 16 AS SAK MS	308 411	213	BVT RS485 5	918 401	169	DB M MOD 150	961 001	33	DG M TNS 385	952 404	56
AK 35 SN 18X3 GG	919 015	214	BVT TC 1	918 411	170	DB M MOD 255	961 002	33	DG M TNS 385 FM	952 409	56
AK RPA V2A	563 169	240	BVT TTY 24	918 400	169	DB M MOD 320	961 003	33	DG M TNS CI 275	952 401	53
AL DCU X PV L1000	900 947	79	BW90 B11 B5.1 6.5 11 V2A			DBH M 1 255	961 122	46	DG M TNS CI 275 FM	952 406	53
AL DCU X PV L600	900 946	79		106 310	206	DBH MOD 255	961 022	46	DG M TT 150	952 323	56
AL DCU Y PV L1000	900 949	79	BW90 B16 B5.1 6.5 11 V2A			DBM 1 255 S	900 220	39	DG M TT 150 FM	952 328	57
AL DCU Y PV L600	900 948	79		106 314	206	DBM 1 440	961 140	38	DG M TT 275	952 310	56
AL EXFS L100 KS	923 025	225	BW90 B17 21 16 V2A	106 329	206	DBM 1 440 FM	961 145	38	DG M TT 275 FM	952 315	57
AL EXFS L200 KS	923 035	225	BXT BAS	920 300	142	DBM 1 760 FM	961 175	38	DG M TT 2P 275	952 110	57
AL EXFS L300 KS	923 045	225	BXT BAS EX	920 301	156	DBM 1 CI 440 FM	961 146	36	DG M TT 2P 275 FM	952 115	57
AL2 10DA LSA	907 997	181	BXT M4 E	920 308	158	DBM 1 CI 760 FM	961 176	36	DG M TT 2P 320	952 130	57
ALGA 5	906 055	214	BXT M4 T	920 309	158	DBM NH00 255	900 255	34	DG M TT 2P 320 FM	952 135	57
ALGA 5 X	906 058	214	BXT ML2 B 180	920 211	148	DBX TC 180	922 210	198	DG M TT 2P 385	952 111	57
AR1 SI	924 338	98	BXT ML2 BD 180	920 247	146	DBX U2 KT BD S 0-180	922 200	198	DG M TT 2P 385 FM	952 116	57
AR1 STW	924 328	97	BXT ML2 BD DL S 15	920 243	148	DBX U4 KT BD S 0-180	922 400	198	DG M TT 2P CI 275	952 171	54
AR1 TW	924 336	98	BXT ML2 BD HFS 5	920 271	147	DCB YPV SCI 1000	900 061	29	DG M TT 2P CI 275 FM	952 176	54
AS SAK 1000 V2A	308 421	211	BXT ML2 BD S 12	920 242	146	DCB YPV SCI 1000 FM	900 066	29	DG M TT 320	952 320	56
AW2 LSA	907 994	181	BXT ML2 BD S 24	920 244	146	DCB YPV SCI 1500	900 062	29	DG M TT 320 FM	952 325	57
			BXT ML2 BD S 48	920 245	146	DCB YPV SCI 1500 FM	900 067	29	DG M TT 385	952 311	56
			BXT ML2 BD S 5	920 240	146	DCB YPV SCI 600	900 060	29	DG M TT 385 FM	952 316	57
BFS 2XM10X80	472 202	237	BXT ML2 BD S EX 24	920 280	156	DCB YPV SCI 600 FM	900 065	29	DG M TT CI 275	952 322	53
BM 10 DRL	907 499	179	BXT ML2 BE HFS 5	920 270	147	DCO SD2	917 900	166	DG M TT CI 275 FM	952 327	53
BS BA1 BA15 BXT	920 398	160	BXT ML2 BE S 12	920 222	147	DCO SD2 E 12	917 987	164	DG M WE 600	952 302	58
BS M10 PAS	472 201	237	BXT ML2 BE S 24	920 224	147	DCO SD2 E 24	917 988	164	DG M WE 600 FM	952 307	58
BSP BAS 4	926 304	142	BXT ML2 BE S 36	920 226	147	DCO SD2 E 48	917 989	164	DG M YPV SCI 1000	952 510	70
BSP M2 BD 12	926 242	153	BXT ML2 BE S 48	920 225	147	DCO SD2 MD 12	917 940	164	DG M YPV SCI 1000 FM	952 515	70
BSP M2 BD 180	926 247	153	BXT ML2 BE S 5	920 220	147	DCO SD2 MD 24	917 941	164	DG M YPV SCI 1200	952 512	70
BSP M2 BD 24	926 244	153	BXT ML2 MY 250	920 289	148	DCO SD2 MD 48	917 942	164	DG M YPV SCI 1200 FM	952 517	70
BSP M2 BD 48	926 245	153	BXT ML2 MY E 110	920 288	148	DCO SD2 MD EX 24	917 960	165	DG M YPV SCI 150	952 513	70
BSP M2 BD 5	926 240	153	BXT ML4 B 180	920 310	144	DCO SD2 MD HF 5	917 970	164	DG M YPV SCI 150 FM	952 518	70
BSP M2 BD 60	926 246	153	BXT ML4 BC 24	920 354	145	DCO SD2 ME 12	917 920	164	DG M YPV SCI 600	952 511	70
BSP M2 BD HF 24	926 275	154	BXT ML4 BC 5	920 350	145	DCO SD2 ME 24	917 921	164	DG M YPV SCI 600 FM	952 516	70
BSP M2 BD HF 5	926 271	154	BXT ML4 BD 12	920 342	144	DCO SD2 ME 48	917 922	164	DG ME YPV SCI 1500	952 520	73
BSP M2 BE 12	926 222	153	BXT ML4 BD 180	920 347	144	DCOR L 1P 275	900 431	65	DG ME YPV SCI 1500 FM		
BSP M2 BE 180	926 227	153	BXT ML4 BD 24	920 344	144	DCOR L 1P 320	900 433	65		952 525	73
BSP M2 BE 24	926 224	153	BXT ML4 BD 48	920 345	144	DCOR L 2P 275	900 430	65	DG MOD 150	952 012	84
BSP M2 BE 48	926 225	153									

Type	Part No.	Page	Type	Part No.	Page	Type	Part No.	Page	Type	Part No.	Page
DG MOD 275	952 010	58	DG S 385 VA FM	952 089	62	DGPM 440	961 160	48	DRL RD 5	907 440	176
DG MOD 275	952 010	84	DG S 440	952 075	59	DGPM 440 FM	961 165	48	DRL RD 60	907 444	176
DG MOD 275 VA	952 027	84	DG S 440 FM	952 095	60	DK 25	952 699	106	DRL RE 12	907 421	175
DG MOD 320	952 013	84	DG S 48	952 078	59	DLI ISDN I	929 024	199	DRL RE 180	907 425	175
DG MOD 385	952 014	84	DG S 48 FM	952 098	60	DLI TC 2 I	929 028	200	DRL RE 24	907 422	175
DG MOD 385 VA	952 029	84	DG S 600	952 076	59	DLI TC BT	929 026	200	DRL RE 48	907 423	175
DG MOD 440	952 015	84	DG S 600 FM	952 096	60	DLI TC ECO RJ12	929 081	200	DRL RE 5	907 420	175
DG MOD 48	952 018	84	DG S 75	952 071	59	DPA M CAT6 RJ45S 48	929 100	190	DRL RE 60	907 424	175
DG MOD 600	952 016	84	DG S 75 FM	952 091	60	DPA M CLD RJ45B 48	929 126	190	DSA 230 LA	924 370	97
DG MOD 75	952 011	84	DG S 75 VA	952 080	62	DPA M CLE RJ45B 48	929 121	190	DSE M 1 220	971 120	43
DG MOD 75 VA	952 025	84	DG S 75 VA FM	952 085	62	DPAN L	910 200	105	DSE M 1 220 FM	971 125	43
DG MOD 750	952 017	84	DG S CI 275	952 079	54	DPG LSA 120 P	906 102	180	DSE M 1 242	971 122	43
DG MOD CI 275	952 020	84	DG S CI 275 FM	952 099	54	DPG LSA 220 P	906 103	180	DSE M 1 242 FM	971 127	43
DG MOD E DC 242	972 020	85	DG S PV SCI 150	952 551	70	DPG LSA 30 P	906 100	180	DSE M 1 60	971 121	43
DG MOD E DC 550	972 030	85	DG S PV SCI 150 FM	952 556	70	DPG LSA 60 P	906 101	180	DSE M 1 60 FM	971 126	43
DG MOD E DC 60	972 010	85	DG S PV SCI 600	952 550	70	DPI CD EXD 230 24 M	929 969	186	DSE M 2P 60	971 221	43
DG MOD E DC 900	972 040	85	DG S PV SCI 600 FM	952 555	70	DPI CD EXD 230 24 N	929 970	186	DSE M 2P 60 FM	971 226	43
DG MOD E H 1000	952 908	85	DG S WE 600	952 077	60	DPI CD EXD 24 M	929 962	185	DSE MOD 220	971 002	44
DG MOD E H LI 1000	952 907	85	DG S WE 600 FM	952 097	60	DPI CD EXD 24 N	929 964	185	DSE MOD 242	971 003	44
DG MOD E H LI 275	952 900	85	DG SE DC 242	972 120	68	DPI CD EXI+D 2X24 M	929 950	188	DSE MOD 60	971 001	44
DG MOD E H LI 320	952 903	64	DG SE DC 242 FM	972 125	68	DPI CD EXI+D 2X24 N	929 951	188	DSE MOD PE 60	971 010	44
DG MOD E H LI 320	952 903	85	DG SE DC 550	972 130	68	DPI CD EXI+D 2X48 M	929 952	186	DSH TN 255	941 200	27
DG MOD E H LI 385	952 904	85	DG SE DC 550 FM	972 135	68	DPI CD EXI+D 2X48 N	929 953	186	DSH TNC 255	941 300	26
DG MOD E H LI 440	952 905	85	DG SE DC 60	972 110	68	DPI CD HF EXD 5 M	929 971	186	DSH TNC 255 FM	941 305	26
DG MOD E PV SCI 750	952 056	85	DG SE DC 60 FM	972 115	68	DPI MD 24 M 2S	929 941	184	DSH TNS 255	941 400	26
DG MOD NPE	952 050	84	DG SE DC 900	972 140	68	DPI MD EX 24 M 2	929 960	185	DSH TNS 255 FM	941 405	26
DG MOD PV 300	952 043	85	DG SE DC 900 FM	972 145	68	DPI ME 24 N A2G	929 921	185	DSH TT 255	941 310	26
DG MOD PV 500	952 041	85	DG SE H 1000 FM	952 938	64	DPL 10 G3 110	907 214	178	DSH TT 255 FM	941 315	27
DG MOD PV 600	952 044	85	DG SE H LI 1000 FM	952 937	64	DPL 10 G3 110 FSD	907 216	178	DSH TT 2P 255	941 110	27
DG MOD PV 75	952 045	85	DG SE H LI 275 FM	952 930	64	DPRO 230	909 230	103	DSI E 3	910 631	41
DG MOD PV SCI 300	952 053	85	DG SE H LI 320 FM	952 933	64	DPRO 230 F	909 240	103	DVO 1 255	900 230	31
DG MOD PV SCI 500	952 051	85	DG SE H LI 385 FM	952 934	64	DPRO 230 ISDN	909 320	195	DV M TN 255	951 200	21
DG MOD PV SCI 600	952 054	85	DG SE H LI 440 FM	952 935	64	DPRO 230 LAN100	909 321	195	DV M TN 255 FM	951 205	21
DG MOD PV SCI 75	952 055	85	DG SE PV SCI 1500	952 561	73	DPRO 230 NT	909 310	195	DV M TNC 255	951 300	21
DG PCB 275	952 610	81	DG SE PV SCI 1500 FM	952 566	73	DPRO 230 TV	909 300	194	DV M TNC 255 FM	951 305	21
DG PCB 275 FM	952 710	82	DG YPV SCI 1000	950 530	75	DR M 2P 150	953 204	91	DV M TNS 255	951 400	21
DG PCB 385	952 614	81	DG YPV SCI 1000 FM	950 535	75	DR M 2P 150 FM	953 209	91	DV M TNS 255 FM	951 405	21
DG PCB 385 FM	952 714	82	DG YPV SCI 600	950 531	75	DR M 2P 255	953 200	91	DV M TT 255	951 310	21
DG PCB I 275 FM	952 910	82	DG YPV SCI 600 FM	950 536	75	DR M 2P 255 FM	953 205	91	DV M TT 255 FM	951 315	21
DG PCB NPE	952 650	82	DGA AG BNC	929 043	205	DR M 2P 30	953 201	91	DV M TT 2P 255	951 110	22
DG PCB NPE FM	952 750	82	DGA AG N	929 045	205	DR M 2P 30 FM	953 206	91	DV M TT 2P 255 FM	951 115	22
DG PCB PV 300	952 643	81	DGA BNC VCD	909 710	204	DR M 2P 60	953 202	91	DV MOD 255	951 001	22
DG PCB PV 300 FM	952 743	81	DGA BNC VCID	909 711	204	DR M 2P 60 FM	953 207	91	DV MOD NPE 100	951 100	22
DG PCB PV 500	952 641	81	DGA F 1.6 5.6	929 040	204	DR M 2P 75	953 203	91	DV MOD NPE 50	951 050	22
DG PCB PV 500 FM	952 741	81	DGA FF TV	909 703	204	DR M 2P 75 FM	953 208	91	DV ZP TNC 255	900 390	23
DG PCB PV 600	952 644	81	DGA G BNC	929 042	204	DR M 4P 255	953 400	90	DV ZP TT 255	900 391	23
DG PCB PV 600 FM	952 744	81	DGA G N	929 044	204	DR M 4P 255 FM	953 405	90	DVCI 1 255	961 200	24
DG PCB PV I 500 FM	952 941	82	DGA G SMA	929 039	204	DR MOD 150	953 014	93	DVCI 1 255 FM	961 205	24
DG PCB PV SCI 300	952 653	81	DGA GF TV	909 704	204	DR MOD 255	953 010	93	DVR 2 BY S 150 FM	928 430	167
DG PCB PV SCI 300 FM	952 753	81	DGA GFF TV	909 705	204	DR MOD 30	953 011	93			
DG PCB PV SCI 500	952 651	81	DGA L4 7 16 MFA	929 148	205	DR MOD 4P 255	953 020	93	EB 1 2 1.5	900 460	111
DG PCB PV SCI 500 FM	952 751	81	DGA L4 7 16 S	929 047	205	DR MOD 60	953 012	93	EB 1 2 5	900 419	112
DG PCB PV SCI 600	952 654	81	DGA L4 N EB	929 059	205	DR MOD 75	953 013	93	EB 1 3 1.5	900 418	111
DG PCB PV SCI 600 FM	952 754	81	DGA LG 7 16 MFA	929 146	205	DRC LC M1+	910 655	218	EB 1 3 10	900 461	112
DG PCB PVSCI I 500FM	952 951	82	DGP C MOD	952 060	66	DRC LC M3+	910 653	218	EB 1 4 1.5	900 429	111
DG S 150	952 072	59	DGP C MOD	952 060	84	DRC MCM XT	910 695	215	EB 1 4 13	900 462	112
DG S 150 FM	952 092	60	DGP C S	952 030	66	DRC SCM XT	910 696	216	EB 1 4 9	900 417	112
DG S 275	952 070	59	DGP C S FM	952 035	66	DRL 10 B 180	907 400	175	EB 4 F	929 095	206
DG S 275 FM	952 090	60	DGP M 255	961 101	48	DRL 10 B 180 FSD	907 401	175	EB 9V LI1300 80	923 099	112
DG S 275 VA	952 082	62	DGP M 255 FM	961 105	48	DRL HD 24	907 470	176	EB DG 1000 1 3	900 411	110
DG S 275 VA FM	952 087	62	DGP M MOD 255	961 010	49	DRL HD 5	907 465	176	EF 10 DRL	907 498	177
DG S 320	952 073	59	DGPH M 255	961 102	48	DRL PD 180	907 430	176	EG NET PRO 10X 19"	929 234	192
DG S 320 FM	952 093	60	DGPH MOD 255	961 020	49	DRL RD 110	907 445	176	EG NET PRO 19"	929 034	192
DG S 385	952 074	59	DGPM 1 255	961 180	48	DRL RD 12	907 441	176	EL 16 B17	929 096	206
DG S 385 FM	952 094	60	DGPM 1 255 FM	961 185	48	DRL RD 24	907 442	176	EL16 L1.05M 1KSO 8.10 1KSG 8	416 411	206
DG S 385 VA	952 084	62	DGPM 1 255 S	900 050	48	DRL RD 48	907 443	176			

Type	Part No.	Page	Type	Part No.	Page	Type	Part No.	Page	Type	Part No.	Page
EL2 38EA LSA	907 993	182	KB 10 DCO RK	919 880	166	PAS 6RK OH	563 105	236	SFL PRO 6X	909 250	104
EM 2 DRL	907 496	177	KFSU	923 021	222	PAS 9AK	563 050	235	SFL PRO 6X 19"	909 251	104
ER DPI M20	929 996	187	KS 198 PAS	563 016	236	PAS AH RK 13X25 1X8.10			SH 18X3 K	919 014	212
ES 10AP 11X11 V2A	472 339	238	KS 398 PAS	563 017	236		563 030	235	SH1 18X3 ST	919 012	212
ES 12AP 11X11 V2A	472 349	238	KS 798 PAS	563 018	236	PAS AH RK 5X25 3X8.10 1XFL30			SH2 18X3 ST	919 013	212
ES 2X2AP 10 ST	472 023	238	KS B11.11 FL30X4 V2A	380 129	240		563 020	235	SKB 19 9M SW	919 030	180
ES 2X2AP 10 V2A	472 109	238	KV M20 MS 10.5	929 984	187	PAS AH RK 7X25 2X8.10 1XFL30			SKB 19 9M SW	919 030	213
ES 2X3AP 10 ST	472 022	238	KV S M20 MS 9.5	929 982	187		563 010	235	SLK 16	910 099	214
ES 2X3AP 10 V2A	472 119	238				PAS AH RK 7X25 2X8.10 1XFL40			SN 18X3 CU 1000	919 016	212
ES 2X4AP 10 V2A	472 129	238	LCS DRC BXT	910 652	218		563 040	235	SPB 25X0.3 L100M V2A	540 901	230
ES 2X4AP ST	472 024	238	LS 1 50 H DCO	917 977	166	PAS I 10AP M10 CU	472 217	237	SPS PRO	912 253	95
ES 2X6AP 10 ST	472 021	238	LS 1 50 V DCO	917 976	166	PAS I 10AP M10 V2A	472 219	237	SR DRL	907 497	177
ES 2X6AP 10 V2A	472 139	238	LWL DSI 18M	910 642	41	PAS I 12AP M10 CU	472 237	237	ST AS SAK K	308 425	211
ES 4AP 11X11 V2A	472 309	238	LWL ST DSI	910 641	41	PAS I 12AP M10 V2A	472 239	237	STAK 25	952 589	106
ES 6AP 11X11 V2A	472 319	238				PAS I 6AP M10 CU	472 207	237	STAK 2X16	900 589	106
ES 8AP 11X11 V2A	472 329	238	MA SDS M12	723 199	233	PAS I 6AP M10 V2A	472 209	237	STC 230	924 350	99
EX BRS 27	540 821	230	MB2 10 LSA	907 995	181	PAS I 8AP M10 CU	472 227	237	SWP MCM ST CENTER	910 489	216
EX BRS 300	540 803	230	MF DR 3RU 19"	929 335	190	PAS I 8AP M10 V2A	472 229	237			
EX BRS 500	540 805	230	ML BXT M4 T	920 394	158	PLOV IGA 12 24	902 317	108	TFS	923 023	222
EX BRS 90	540 801	230	MMVK R16 R25 ST	308 041	239	PM 20	910 511	219	TL2 10DA CC	907 991	182
EXFS 100	923 100	224	MMVK R16 R25 STBL	308 040	239	PSU DC24 30W	910 499	159	TL2 10DA LSA	907 996	182
EXFS 100 KU	923 101	224	MS ALGA 5 X	906 059	158	PSU DC24 30W	910 499	216	TW DRC MCM EX	910 697	157
EXFS KU	923 019	223	MS ALGA 5 X	906 059	214				TW DRC MCM EX	910 697	216
EXFS L100	923 060	223	MS DPA	929 199	190	RK 16 PAS	563 011	236			
EXFS L200	923 061	223	MVS 1 2	900 617	109	RK 95 PAS	563 013	236	UGKF BNC	929 010	202
EXFS L300	923 062	223	MVS 1 3	900 615	109	RK FL30 PAS	563 012	236	USB NANO 485	910 486	159
			MVS 1 4	900 610	109	RK FL40 PAS	563 019	236	USB NANO 485	910 486	216
			MVS 1 57	900 612	110				USD 15 V11 S B	924 051	208
FRH 11 6.10 WA11 B7 CU			MVS 1 6	900 815	110	SA KRF 10 V2A	919 031	213	USD 25 V24 HS S B	924 046	208
	277 237	240	MVS 1 7	900 848	110	SA KRF 15 V2A	919 032	213	USD 9 V24 S B	924 061	208
FRH 11 6.10 WA11 B7 STTZN			MVS 1 8	900 611	110	SA KRF 22 V2A	919 033	213			
	277 230	240	MVS 3 6 6	900 595	110	SA KRF 29 V2A	919 034	213			
FRH 11 6.10 WA11 B7 V2A			MVS 3 6 8	900 813	110	SA KRF 37 V2A	919 035	213	V NH00 280	900 261	88
	277 239	240	MVS 3 6 9	900 839	111	SA KRF 50 V2A	919 036	213	V NH00 280 FM	900 263	88
FRH 11 6.10 WA15 B7 STTZN			MVS 4 56	900 614	111	SA KRF 70 V2A	919 037	213	V NH1 280	900 270	88
	277 240	240	MVS 4 8 11	900 814	111	SA KRF 94 V2A	919 038	213	VA NH00 280	900 262	88
FS 25E HS 12	924 018	208				SAK 10 AS V4A	308 403	211	VA NH00 280 FM	900 264	88
FS 9E HS 12	924 019	208	NAK SN4631	999 990	226	SAK 11 SN MS	919 011	212	VA NH1 280	900 271	88
FS 9E PB 6	924 017	207	NET PRO 10X TC1 RST	929 230	192	SAK 14 AS V4A	308 404	211	VC 280 2	900 471	102
			NET PRO 4TP	929 035	191	SAK 18 AS V4A	308 405	211	VCS D 40 IP65	923 401	112
GDT 230 B3	907 218	177	NET PRO 4TP 30	929 037	191	SAK 21 AS V4A	308 406	211	VK 6.10 FL30 FL30 BSB STTZN		
GDT 230 B3 FSD	907 219	177	NET PRO E1 LSA G703	929 075	192	SAK 26 AS V4A	308 407	211		308 026	239
GDT 230 G3	907 208	178	NET PRO LSA 4TP	929 036	191	SAK 33 AS V4A	308 408	211	VK 6.22 FL40 KB6.10 BSB STBL		
GDT 230 G3 FSD	907 217	178	NET PRO TC 2	929 071	192	SAK 6.5 SN MS	919 010	212		308 035	239
GDT DGA 230	929 498	206	NET PRO TC 2 LSA	929 072	192	SAK BXT LR	920 395	159	VK A R22 F40 STBL	308 030	239
GDT DGA 470	929 499	206	NF 10	912 254	94	SB PAS RK	563 014	236	VK A UNI ST	308 025	239
GDT DGA 90	929 497	206	NSM PRO SI	924 337	98	SCK EX BRS ASSM10 V2A			VK DB 20.32 6.10 FL40 BSB STBL		
			NSM PRO TW	924 335	98		540 810	230		308 036	239
IGA 10 V2 IP54	902 315	107				SDS 1	923 110	232	VK DB 6.20 6.10 FL30 BSB STBL		
IGA 12 IP54	902 471	108	P 2	910 502	113	SDS 2	923 117	232		308 031	239
IGA 12 IP65	902 316	108	PA BXT	910 508	219	SDS 3	923 116	232	VK EH R10 F30 ST	308 120	240
IGA 24 IP54	902 472	108	PA DRL	910 507	219	SDS 4	923 118	233	VK EH R10 F30 V2A	308 129	240
IGA 6 IP54	902 485	107	PAS 11AK	563 200	235	SDS 5	923 119	233			
IGA 7 IP54	902 314	107	PAS 11AK UV	563 201	235				ZAP STW	924 329	97
IS PAS M10	472 210	237									
ITAK EXI BXT 24	989 408	158									

## Key Words

Product	Page	Product	Page	Product	Page
Accessories DEHNconnect SD2	166	DEHNguard modular	55	FS	207
Accessories DEHNpipe	187	DEHNguard modular E (Y)PV SCI 1500	72	Impulse Counter	113
Accessories DEHNrapid LSA	177	DEHNguard modular with integrated Backup Fuse	52	Insulating Enclosure	107
Accessories for BLITZDUCTOR XT/XTU/SP/XT Ex (i)	158	DEHNguard modular (Y)PV SCI ...	69	ITAK Ex (i)	158
Accessories for LSA Technology	181	DEHNguard PCB	80	LifeCheck SPD Test Devices	217
AL DCU X / AL DCU Y	78	DEHNguard S	59	Mains Filter NF 10	94
BLITZDUCTOR SP	151	DEHNguard SE DC ... (FM)	67	NET Protector	191
BLITZDUCTOR VT	168	DEHNguard SE H LI ... FM	63	NSM Protector	98
BLITZDUCTOR VT KKS	171	DEHNguard S ... VA	61	Pipe Clamps for Hazardous Areas Zone	229
BLITZDUCTOR XT	143	DEHNguard YPV SCI ... – compact	74	SFL Protector	104
BLITZDUCTOR XT Ex (i)	155	DEHNlink	199	Shield Connection for Cables	213
BLITZDUCTOR XTU	149	DEHNpanel	105	Shield Connection on Anchor Bars	210
Busbars / Modular Wiring System	109	DEHNpatch	189	Shield Connection on DIN Rails	212
BUSector	196	DEHNpipe	184	SPD Test Device	114/219
Components for Ring Equipotential Bonding	240	DEHNprotector	103	SPS Protector	95
Condition Monitoring-System with LifeCheck Sensor	215	DEHNprotector – Combined Adapter	194	STC Module	99
Connecting Clamps	239	DEHNrail modular	90	Voltage Limiting Devices	231
Definition of Symbols	12	DEHNrail modular, multipole	92	Voltage Controlled Short-Circuiting Device	227
DEHN Enclosure for Equipotential Bonding	179	DEHNrapid LSA	174	Terms and Definitions	9
DEHNbloc	45	DEHNsafe	96	TFS / KFSU	222
DEHNbloc Maxi	34	DEHNsecure modular	42	UGKF	202
DEHNbloc Maxi 1 CI 440 / 760 FM	39	DEHNshield	25	USD	207
DEHNbloc Maxi 440 / 760	37	DEHNsignal	40	VC 280 2	102
DEHNbloc Maxi S	39	DEHNsolid	31	V NH / VA NH	87
DEHNbloc modular	32	DEHNvario	167	Wiring Accessories DK / STAK	106
DEHNbox	197	DEHNvenCI	24		
DEHNcombo	28	DEHNventil modular	20		
DEHNconnect SD2	163	DEHNventil ZP	23		
DEHNconnect SD2 Ex (i)	165	DPL 10 G3	178		
DEHNcord	65	Earthing Busbars	240		
DEHNcube	76	Earthing Busbars, single-row / two-row	238		
DEHNflex	100	Enclosure and Protective Conductor Terminal	214		
DEHNgap	47	Equipotential Busbars	235		
DEHNgap C S	66	Easy Choice – Industrial Building	13-1		
DEHNgate	203	Easy Choice – Office Building	14		
DEHNguard <sup>5</sup> 1000	86	Easy Choice – Residential Building	14-1		
		EXFS 100 / EXFS 100 KU	224		
		EXFS Coaxial Connection Box	226		
		EXFS L / EXFS KU	223		



## 1. General, Scope

1.1 All deliveries and services in business dealings with entrepreneurs take place exclusively under our general terms of sale (hereinafter "terms of sale"). We oppose deviating regulations, especially conflicting terms of purchase of the customer, unless we expressly agreed to the validity in writing. Our terms of sale apply even if we complete unconditional delivery to the customer while knowing that the terms of sale of the customer are in conflict with our own.

1.2 Our terms of sale only apply to entrepreneurs within the meaning of section 310, paragraph 1 of the German Civil Code (BGB), to current business relationships and to all future transactions with the customer.

## 2. Offer and Order, Reservation of Right of Modification and Copyright

2.1 Except where expressly identified by us as binding, documents such as diagrams, drawings and measurements, in particular in print media and online on our website [www.dehn-international.com](http://www.dehn-international.com), are only indicative.

2.2 Should our order confirmation contain reasonable expansions, limitations, or other modifications with respect to the order, then the customer's agreement is implied, if he/she does not immediately, at the latest however within 3 business days from receipt of the order confirmation, oppose it.

2.3 Any order placed in our web shop shall be regarded as an offer to conclude a sales contract. A sales contract only comes into existence if the customer receives a written order confirmation or the goods are delivered / services are rendered.

2.4 Our goods are only delivered in the packaging units indicated in the catalogues. If a different number of items is ordered, the amount and price of the next larger packaging unit is considered agreed upon.

2.5 We reserve the right to make technical modifications to our services, insofar as such modifications promote technical progress or are unavoidable based on other circumstances and are reasonable for the customer.

2.6 We reserve ownership and copyright rights to diagrams, drawings, calculations, and other documents; these may not be made available to third parties without our express written consent.

## 3. Prices, Value-Added Tax, Packaging Costs

3.1 Our prices are subject to change without notice.

3.2 Prices include, insofar as nothing else is arranged, customary packaging from our plant without value-added tax. On the day of invoicing, the legally identified VAT amount is to be reimbursed to us.

3.3 The cost of non-customary packaging, e.g., collective or seaworthy packaging, is invoiced separately. The customer bears the cost of the disposal or return of packaging.

## 4. Passing of Risk, Optional Insurance

The risk of accidental loss and deterioration passes to the customer upon dispatch to the customer from our warehouse or plant, even if carriage-paid delivery is agreed upon. At the request and expense of the customer, we will insure the delivery against breakage, damage to goods in transit and fire damage.

## 5. Payment Due Dates, Discounts, Right of Refusal, Default, Small Order Quantity Surcharge

5.1 Unless otherwise agreed, invoices are payable net 10 days. The customer shall pay the costs of payment. Discount amounts are deductible only if they have been agreed on with us and all accounts payable due have been paid.

5.2 If the customer is in default with his payments, interest on the outstanding amount shall be payable at the rate of 9% above the base interest rate. We reserve the right to prove and allege higher default damages. The right of early notice of default remains unchanged. If we are required to advance performance and, if after the execution of the contract, it becomes apparent that our claim, in particular for payment, may be jeopardised by the customer's inability to perform, we may refuse performance.

5.3 The customer cannot charge counter-claims against our due payment claims or exercise a right of retention, unless the customer is entitled to a claim recognised by declaratory judgement that is not contested by us and if, while exercising the right of retention, the counter-claim from the customer is based on the same contractual relationship.

5.4 Orders, with the exception of cash sales, for which the net amount (invoiced amount without shipping costs and value-added tax) is less than €75.00, a small order surcharge of €25.00 will be charged.

## 6. Retention of Title, Assignment, Release of Securities

6.1 Delivered goods remain our property until the payment of all open business claims up to the point of invoicing. The claims of the customer including value-added tax from the resale of reserved goods, i.e., from a work performance using our goods, should already be transferred to us in the amount of the open invoice. In the case that the reserved goods from the customer are sold together with other

goods that do not belong to us, whether it be without or after processing, or are delivered within the framework of a working contract, the assignment of the resulting claim of the reserve buyer is calculated in the amount of the value of the reserved goods.

6.2 Should the value of the granted securities exceed the claims by more than 10%, we are obliged to retransfer or release the securities upon request. We shall select the securities to be released.

6.3 Our goods may only be transferred within the framework of proper business activity. The customer is not allowed to pawn or transfer the ownership of goods that are still in our possession.

6.4 At our request, the customer is obliged to inform us of the purchaser and the arranged price and to show the assignment to its debtor.

## 7. Delivery Period and Date

7.1 The start of the delivery period presupposes the involvement of the customer for the clarification of all technical questions.

7.2 Delivery periods as well as delivery dates will be appropriately extended if they cannot be adhered to as a result of military mobilisation, war, uprising, strike or lockout, delayed delivery of raw and auxiliary materials, late delivery by our suppliers, or similar circumstances beyond our control. A lasting obstruction under these circumstances gives us the right to withdraw from the contract without liability for damages.

## 8. Liability for Material and Title Defects

8.1 We shall assume liability without restriction in compliance with the statutory regulations, provided that the customer asserts claims for damage compensation, which are attributable to wilful intent or gross negligence, including wilful intent and gross negligence on the part of our representatives or vicarious agents.

8.2 We shall assume liability without restriction in compliance with the statutory regulations, in case of culpable injury to life, limb or health; this shall also apply to the mandatory liability under the Product Liability Act.

8.3 In so far as a defect of the subject of the contract exists for which we are liable, we shall at our discretion either remedy the defect or deliver a non-defective object of the contract (subsequent performance).

8.4 If said subsequent performance should fail or if it is unreasonable for the customer, or if we refuse seriously and conclusively to do so or if we have delayed rectification unreasonably or if other circumstances prevail, which justify immediate withdrawal or damage compensation, taking account of the interests on both sides, then the customer shall be entitled to reduce the contract price or to withdraw from the contract and/or to demand damage compensation. In the event of only a slight infringement of contract, in particular in the event of only slight defects, the customer shall not be entitled to withdraw.

8.5 If the customer should choose only damage compensation after the failure of subsequent performance, then the subject of the contract shall remain with the customer, if this can be reasonably expected. Damage compensation shall be restricted – subject to item 8.1 and 8.2 – to the difference between the purchase price (without value added tax) and the value of the defective subject of the contract remaining with the purchaser.

8.6 Insofar as not otherwise specified above, liability shall be excluded.

8.7 The limitation period for claims based on defects, – subject to item 8.1 and 8.2 – shall be 12 months from delivery of the goods.

8.8 Items 8.1 to 8.7 shall not affect the rights of the customer, if we have fraudulently concealed a defect or have assumed a guarantee for quality.

## 9. Overall liability

9.1 Any further liability for compensation than that provided in item 8 – irrespective of the legal nature of the asserted claim – shall be excluded. This shall in particular apply to damage claims for liabilities resulting from culpa in contrahendo, for other breaches of duty or for tortious claims for damage compensation acc. to § 823 BGB (German code civil law).

9.2 Limitation according to 9.1 shall also apply, insofar as the customer claims reimbursement for useless expenditures instead of claiming compensation for damages in place of performance.

9.3 As far as the liability for compensation against us is excluded or restricted, this shall also apply with regard to the personal liability for damages of our employees, workers, representatives and vicarious agents.

## 10. Return of Goods without Legal Liability

10.1 If no legal claim to return exists, delivered goods will be accepted only with previous agreement from us. Returns without previous agreement will be send back – postage-

due – to the sender without inspection. The customer bears the shipping costs for the return delivery in No. 10.1.

10.2 The goods must still be in the original packaging. Special orders or deliveries dating back further than three months cannot be returned. In order to cover the costs of goods returns, a processing fee of 20% of the net value of the goods or €25.00, whichever is the greater, shall be applied, unless the customer can prove to us that we have incurred no or considerably smaller damage. If the goods can no longer be resold at the list price at the time of the return, an additional deduction (old goods deduction) will be made in addition to the processing fee. If we make an exception and agree to accept the return of parts that are unpackaged and that are no longer in their original packaging, an expense remuneration of at least 15% will be charged for reworking and repackaging in addition to the processing fee and, if applicable, the old goods deduction, unless the customer can prove to us that we have incurred no or considerably smaller damage.

10.3 Returned goods will only be credited to a new invoice. Credits cannot be used to clear invoices due at the time of the return.

## 11. Product Information, No Advisory Obligation

Our deliveries are intended only for speciality stores or skilled users. Our user information and instructions are limited to the details of each written product information (e.g., installation instructions, catalogues, data sheets). Further advisory obligations do not exist. Application, use, and processing of the products lie solely in the customer's realm of responsibility.

## 12. Additional Conditions for the Provision of Services

12.1 We make our offers without conducting a separate test to ascertain the suitability of the products for the relevant customer project. Our liability is excluded unless we were aware of anything contrary to suitability or we were not so aware due to gross negligence. The customer is responsible for conducting the requisite test.

12.2 We also make our offers on the basis of the specifications submitted by the customer without conducting a separate test to ascertain the suitability of the products on an individual basis. Our liability is excluded unless we were aware of anything contrary to suitability or we were not so aware due to gross negligence when checking the specifications. The customer is responsible for conducting the requisite test.

12.3 Our application proposals with product recommendations are of a general nature and are neither designed for application to an individual case nor intended to enable such application. Our application proposals are therefore non-binding. We do not accept any liability in this respect. It is absolutely essential to conduct an appropriate test on an individual basis. The customer is responsible for conducting such a test.

12.4 Our concept proposals with product recommendations do not replace the prevailing recognised engineering standards. The concept proposals with product recommendations do not claim to be exhaustive, unless expressly agreed otherwise. We do not plan systems or parts thereof. In particular, our concept proposals with product recommendations do not replace specific planning and testing. This lies in the customer's realm of responsibility. We do not accept any liability in this respect.

12.5 The sole purpose of the seminars we organise for the customer is to broaden his knowledge and to enable him to check his level of knowledge. We do not monitor and test the knowledge that the customer acquires and applies. We do not accept any liability in this respect. The seminars will always be kept up to date so that they meet the requirements of the recognised engineering standards.

## 13. Use and Protection of Customer Data

We use customer data, which concern the business dealings with the customer, in terms of the Federal Data Protection Act.

## 14. Applicable Law, Jurisdiction

14.1 German law applies to the mutual contractual obligations, their materialisation, interpretation, and implementation as well as all resulting contractual and business relationships. The application of the UN Agreement on Contracts on the International Purchase of Goods and the thereafter enacted laws of the Federal Republic of Germany is excluded.

14.2 Place of performance and jurisdiction for delivery, payment, and for all obligations, including those from exchange and cheque payments – if the customer is a businessperson, legal entity of public law or of special fund under public law – is exclusively Nürnberg.

## 15. VAT Identification Number

VAT ID No. DE 133251475

DEHN + SÖHNE GmbH + Co.KG.  
Nürnberg – Neumarkt

\* The original German text shall be the governing version.



Surge Protection  
Lightning Protection  
Safety Equipment  
DEHN protects.

DEHN + SÖHNE  
GmbH + Co.KG.

Hans-Dehn-Str. 1  
Postfach 1640  
92306 Neumarkt  
Germany

Phone +49 9181 906-0  
Fax +49 9181 906-1100  
sales@dehn.de  
[www.dehn-international.com](http://www.dehn-international.com)



[www.dehn-international.com](http://www.dehn-international.com)



Follow us on Facebook, LinkedIn,  
YouTube, Google+, Xing.

Information on our registered trademarks in the internet at [www.dehn-international.com/en/our-registered-trademarks](http://www.dehn-international.com/en/our-registered-trademarks).  
Technical modifications, misprints, and errors are reserved. Figures are without obligation.